

User Manual

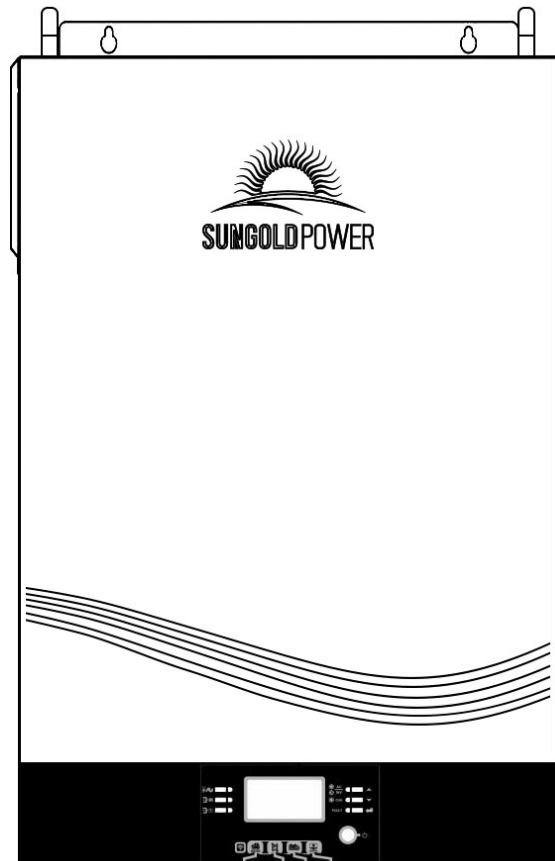

Hybrid BluePower TP6048 INVERTER / CHARGER

Table Of Contents

ABOUT THIS MANUAL	1
Purpose.....	1
Scope.....	1
SAFETY INSTRUCTIONS.....	1
INTRODUCTION	2
Product Overview.....	3
INSTALLATION.....	4
Unpacking and Inspection.....	4
Preparation	4
Mounting the Unit.....	4
Battery Connection	5
AC Input/Output Connection.....	6
PV Connection	7
Final Assembly.....	8
Communication Connection.....	9
Dry Contact Signal	9
OPERATION.....	10
Power ON/OFF	10
Operation and Display Panel	10
LCD Display Icons	11
LCD Setting.....	12
Display Setting	18
Operating Mode Description	23
SPECIFICATIONS	27
TROUBLE SHOOTING	28
Appendix I: Parallel function	29
Appendix II: BMS Communication Installation	39
Appendix III: Approximate Back-up Time Table	46
Appendix IV: The Wi-Fi Operation Guide in Remote Panel.....	47

ABOUT THIS MANUAL

Purpose

This manual describes the assembly, installation, operation and troubleshooting of this unit. Please read this manual carefully before installations and operations. Keep this manual for future reference.

Scope

This manual provides safety and installation guidelines as well as information on tools and wiring.

SAFETY INSTRUCTIONS



WARNING: This chapter contains important safety and operating instructions. Read and keep this manual for future reference.

1. Before using the unit, read all instructions and cautionary markings on the unit, the batteries and all appropriate sections of this manual.
2. **CAUTION** –To reduce risk of injury, charge only deep-cycle lead acid type rechargeable batteries. Other types of batteries may burst, causing personal injury and damage.
3. Do not disassemble the unit. Take it to a qualified service center when service or repair is required. Incorrect re-assembly may result in a risk of electric shock or fire.
4. To reduce risk of electric shock, disconnect all wirings before attempting any maintenance or cleaning. Turning off the unit will not reduce this risk.
5. **CAUTION** – Only qualified personnel can install this device with battery.
6. **NEVER** charge a frozen battery.
7. For optimum operation of this inverter/charger, please follow required spec to select appropriate cable size. It's very important to correctly operate this inverter/charger.
8. Be very cautious when working with metal tools on or around batteries. A potential risk exists to drop a tool to spark or short circuit batteries or other electrical parts and could cause an explosion.
9. Please strictly follow installation procedure when you want to disconnect AC or DC terminals. Please refer to INSTALLATION section of this manual for the details.
10. Fuses are provided as over-current protection for the battery supply.
11. **GROUNDING INSTRUCTIONS** -This inverter/charger should be connected to a permanent grounded wiring system. Be sure to comply with local requirements and regulation to install this inverter.
12. **NEVER** cause AC output and DC input short circuited. Do NOT connect to the mains when DC input short circuits.
13. **Warning!!** Only qualified service persons are able to service this device. If errors still persist after following troubleshooting table, please send this inverter/charger back to local dealer or service center for maintenance.

INTRODUCTION

This hybrid PV inverter can provide power to connected loads by utilizing PV power, utility power and battery power.

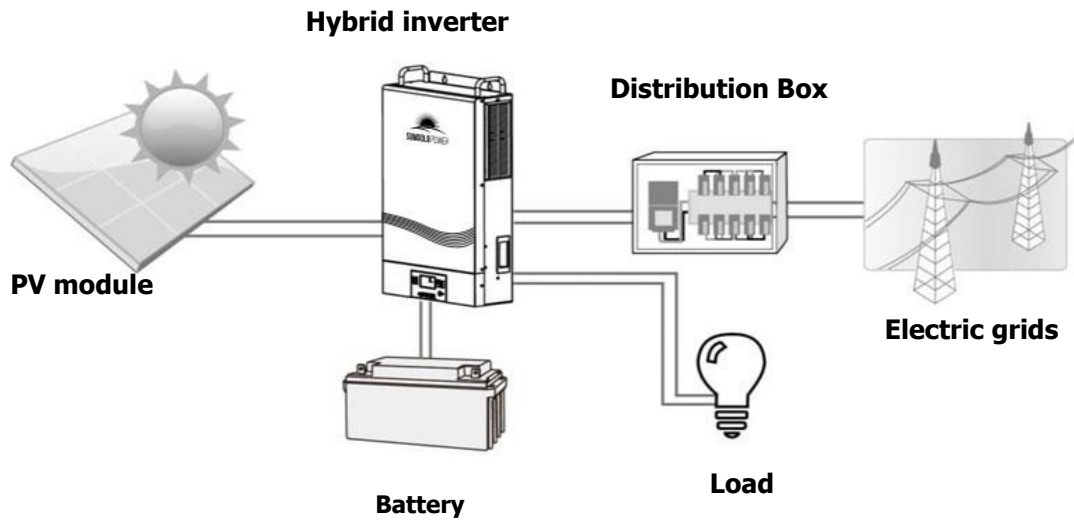
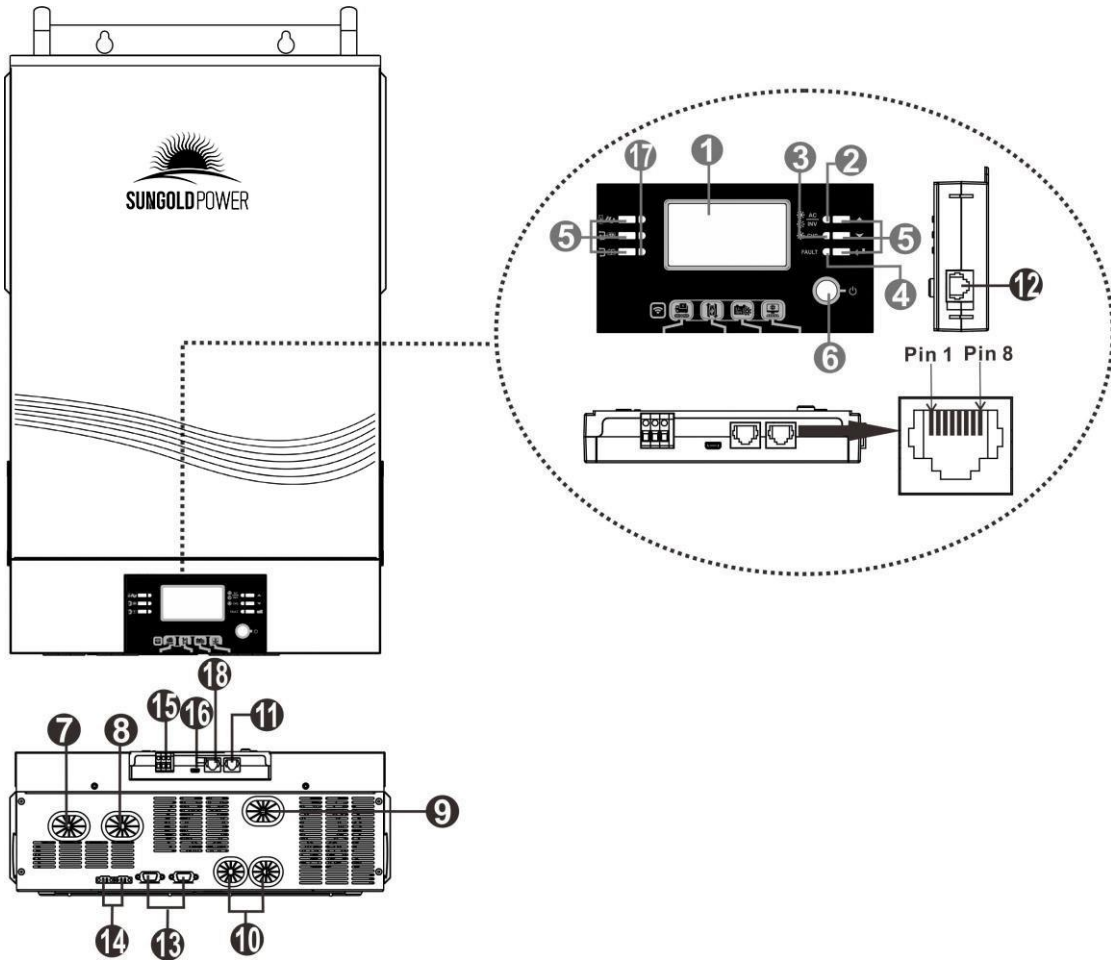

Figure 1 Basic hybrid PV System Overview

Depending on different power situations, this hybrid inverter is designed to generate continuous power from PV solar modules (solar panels), battery, and the utility. When MPP input voltage of PV modules is within acceptable range (see specification for the details), this inverter is able to generate power to feed the grid (utility) and charge battery. **Never connect the positive and negative terminals of the solar panel to the ground.** See Figure 1 for a simple diagram of a typical solar system with this hybrid inverter.

Product Overview



NOTE: For parallel model installation and operation, please check separate parallel installation guide for the details.

1. LCD display
2. Status indicator
3. Charging indicator
4. Fault indicator
5. Function buttons
6. Power on/off switch
7. AC input connectors
8. AC output connectors (Load connection)
9. PV connectors
10. Battery connectors
11. RS-232 communication port
12. Remote LCD panel communication port
13. Parallel communication port (only for parallel model)
14. Current sharing port (only for parallel model)
15. Dry contact
16. USB communication port
17. LED indicators for USB function setting / Output source priority timer / Charger source priority setting
18. BMS communication port: CAN, RS-485 or RS-232

INSTALLATION

Unpacking and Inspection

Before installation, please inspect the unit. Be sure that nothing inside the package is damaged. You should have received the following items inside of package:

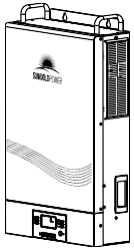

Inverter unit



Software CD



Manual



RS-232 cable

Preparation

Before connecting all wirings, please take off bottom cover by removing four screws as shown below.

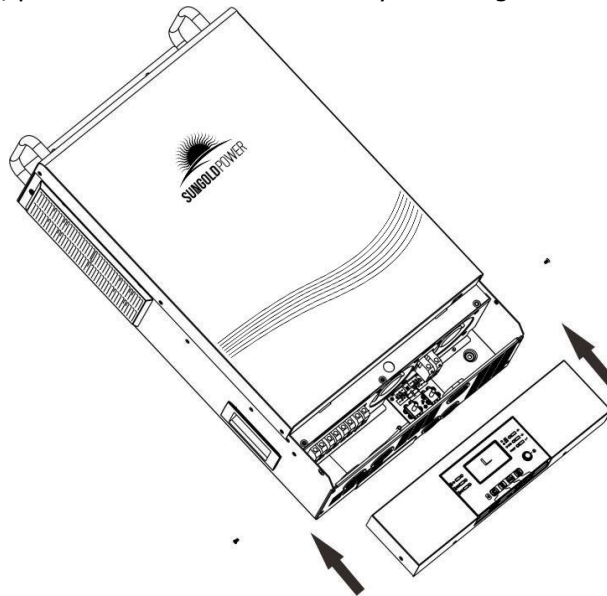

Mounting the Unit

Consider the following points before selecting where to install:

- Do not mount the inverter on flammable construction materials.
- Mount on a solid surface.
- Install this inverter at eye level in order to allow the LCD display to be read at all times.
- The ambient temperature should be between 0°C and 55°C to ensure optimal operation.
- The recommended installation position is to be adhered to the wall vertically.
- Be sure to keep other objects and surfaces as shown in the right diagram to guarantee sufficient heat dissipation and to have enough space for removing wires.

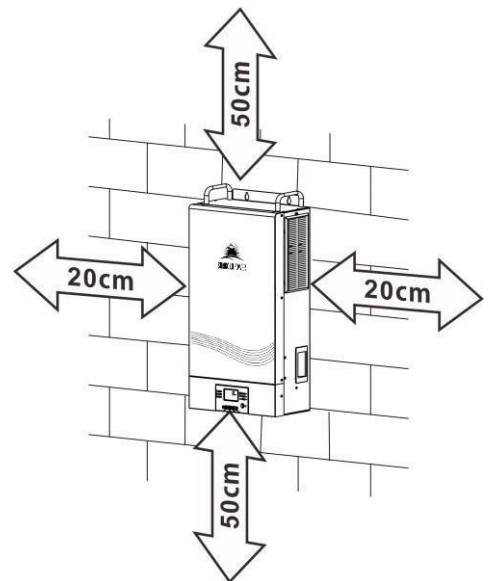

SUITABLE FOR MOUNTING ON CONCRETE OR OTHER NON-COMBUSTIBLE SURFACE ONLY.

Install the unit by screwing three screws. It's recommended to use M4 or M5 screws.

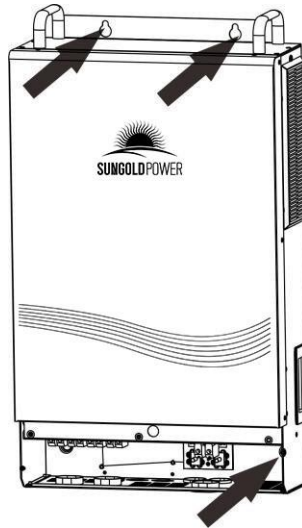

Battery Connection

CAUTION: For safety operation and regulation compliance, it's requested to install a separate DC over-current protector or disconnect device between battery and inverter. It may not be requested to have a disconnect device in some applications, however, it's still requested to have over-current protection installed. Please refer to typical amperage in below table as required fuse or breaker size.

WARNING! All wiring must be performed by a qualified personnel.

WARNING! It's very important for system safety and efficient operation to use appropriate cable for battery connection. To reduce risk of injury, please use the proper recommended cable and terminal size as below.

Ring terminal:

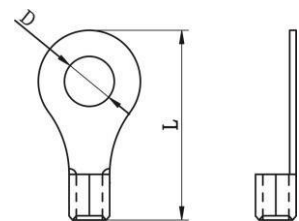



Recommended battery cable and terminal size:

Model	Typical Amperage	Battery Capacity	Wire Size	Ring Terminal			Torque Value
				Cable mm ²	Dimensions		
					D (mm)	L (mm)	
BluePower TP6048	137A	200AH	1*2AWG	38	6.4	33.2	2~3 Nm

Please follow below steps to implement battery connection:

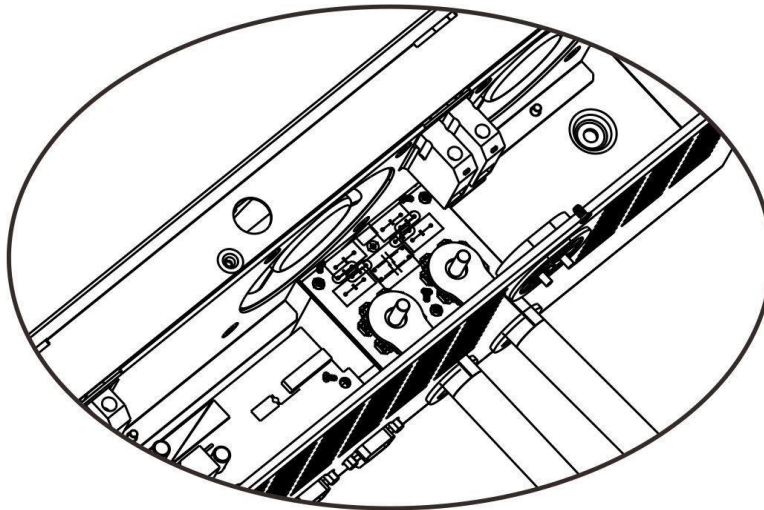
1. Assemble battery ring terminal based on recommended battery cable and terminal size.
2. Insert the ring terminal of battery cable flatly into battery connector of inverter and make sure the nuts are tightened with torque of 2-3 Nm. Make sure polarity at both the battery and the inverter/charge is correctly connected and ring terminals are tightly screwed to the battery terminals.



 **WARNING: Shock Hazard**
Installation must be performed with care due to high battery voltage in series.

 **CAUTION!!** Do not place anything between the flat part of the inverter terminal and the ring terminal. Otherwise, overheating may occur.
CAUTION!! Do not apply anti-oxidant substance on the terminals before terminals are connected tightly.
CAUTION!! Before making the final DC connection or closing DC breaker/disconnector, be sure positive (+) must be connected to positive (+) and negative (-) must be connected to negative (-).

AC Input/Output Connection

CAUTION!! Before connecting to AC input power source, please install a **separate** AC breaker between inverter and AC input power source. This will ensure the inverter can be securely disconnected during maintenance and fully protected from over current of AC input.

CAUTION!! There are two terminal blocks with "IN" and "OUT" markings. Please do NOT mis-connect input and output connectors.

WARNING! All wiring must be performed by a qualified personnel.

WARNING! It's very important for system safety and efficient operation to use appropriate cable for AC input connection. To reduce risk of injury, please use the proper recommended cable size as below.

Suggested cable requirement for AC wires

Model	Gauge	Torque Value
BluePower TP6048	10 AWG	1.2~ 1.6 Nm

Please follow below steps to implement AC input/output connection:

1. Before making AC input/output connection, be sure to open DC protector or disconnector first.
2. Remove insulation sleeve 10mm for eight conductors.
3. Insert AC input wires according to polarities indicated on terminal block and tighten the terminal screws. Be sure to connect PE protective conductor (⊕) first.

⊕ → **Ground (yellow-green)**

L1 → **LINE (black)**

L2 → **LINE (brown)**

N → **Neutral (blue)**

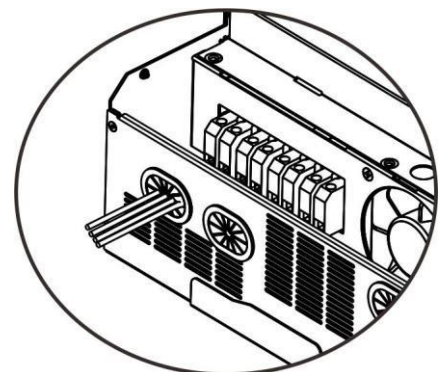

	<p>WARNING: Be sure that AC power source is disconnected before attempting to hardwire it to the unit.</p>
---	---

4. Then, insert AC output wires according to polarities indicated on terminal block and tighten terminal screws.
Be sure to connect PE protective conductor (⊕) first.

⊕ → **Ground (yellow-green)**

L1 → **LINE (black)**

L2 → **LINE (brown)**

N → **Neutral (blue)**

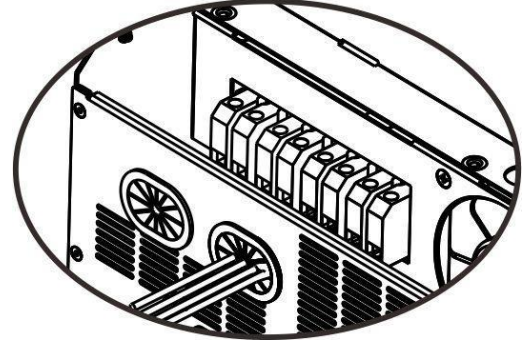

5. Make sure the wires are securely connected.

<p>CAUTION: Important Be sure to connect AC wires with correct polarity. If L and N wires are connected reversely, it may cause utility short-circuited when these inverters are worked in parallel operation.</p>
<p>CAUTION: Appliances such as air conditioner are required at least 2~3 minutes to restart because it's required to have enough time to balance refrigerant gas inside of circuits. If a power shortage occurs and recovers in a short time, it will cause damage to your connected appliances. To prevent this kind of damage, please check manufacturer of air conditioner if it's equipped with time-delay function before installation. Otherwise, this inverter/charger will trig overload fault and cut off output to protect your appliance but sometimes it still causes internal damage to the air conditioner.</p>

PV Connection

CAUTION: Before connecting to PV modules, please install **separately** a DC circuit breaker between inverter and PV modules.

WARNING! All wiring must be performed by a qualified personnel.

WARNING: Please switch off the inverter before you connect PV modules. Otherwise, it will damage the inverter.

WARNING! It's very important for system safety and efficient operation to use appropriate cable for PV module connection. To reduce risk of injury, please use the proper recommended cable size as below.

Model	Typical Amperage	Cable Size	Torque
BluePower TP6048	27A	10AWG	2.0~2.4Nm

PV Module Selection:

When selecting proper PV modules, please be sure to consider below parameters:

1. Open circuit Voltage (Voc) of PV modules not exceeds max. PV array open circuit voltage of inverter.
2. Open circuit Voltage (Voc) of PV modules should be higher than min. battery voltage.

Solar Charging Mode	
INVERTER MODEL	BluePower TP6048
Max. PV Array Open Circuit Voltage	450 Vdc
PV Array MPPT Voltage Range	120~430Vdc
MPP Number	1

Please follow below steps to implement PV module connection:

1. Remove insulation sleeve 10 mm for positive and negative conductors.
2. Check correct polarity of connection cable from PV modules and PV input connectors. Then, connect positive pole (+) of connection cable to positive

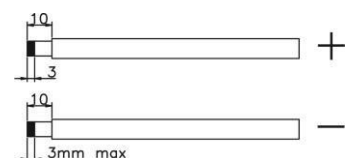

pole (+) of PV input connector. Connect negative pole (-) of connection cable to negative pole (-) of PV input connector.

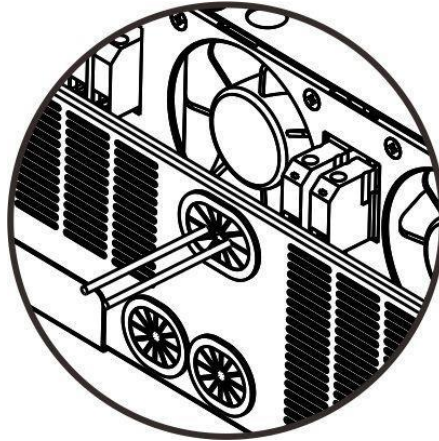

Recommended PV module Configuration

PV Module Spec. (reference)	Total solar input power	Solar input	Q'ty of modules
- 250Wp	1500W	6 pieces in series	6 pcs
- Vmp: 30.7Vdc	2000W	8 pieces in series	8 pcs
- Imp: 8.15A	2750W	11 pieces in series	11 pcs
- Voc: 37.4Vdc	3000W	6 pieces in series 2 strings in parallel	12 pcs
- Isc: 8.63A	4000W	8 pieces in series 2 strings in parallel	16 pcs
- Cells: 60	5000W	10 pieces in series 2 strings in parallel	20 pcs
	6000W	12 pieces in series 2 strings in parallel	24 pcs

Final Assembly

After connecting all wirings, please put bottom cover back by screwing four screws as shown below.

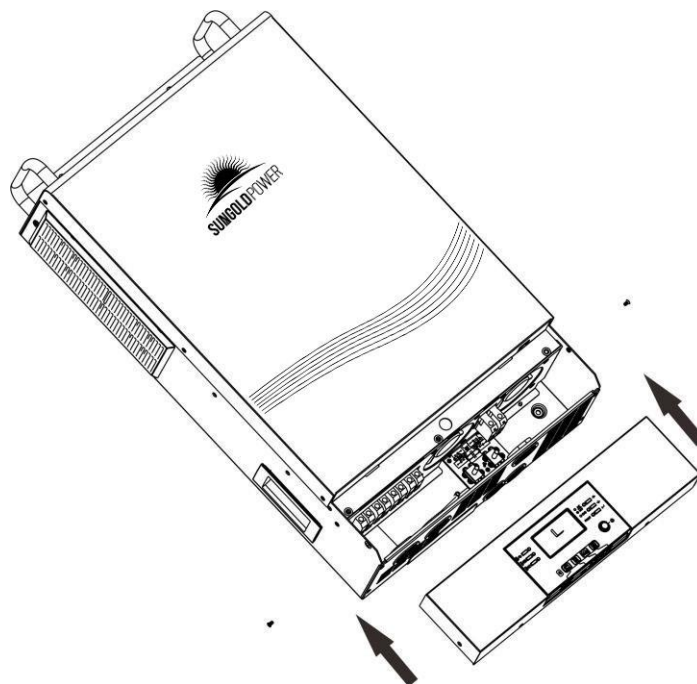

Communication Connection

Serial Connection

Please use supplied communication cable to connect to inverter and PC. Insert bundled CD into a computer and follow on-screen instruction to install the monitoring software. For the detailed software operation, please check user manual of software inside of CD.

Wi-Fi Connection

Wi-Fi module can enable wireless communication between off-grid inverters and monitoring platform. Users have complete and remote monitoring and controlling experience for inverters when combining Wi-Fi module with SolarPower APP, available for both iOS and Android based device. All data loggers and parameters are saved in iCloud. Refer to Appendix IV for detailed operation.



Dry Contact Signal

There is one dry contact (3A/250VAC) available on the rear panel. It could be used to deliver signal to external device when battery voltage reaches warning level.

Unit Status	Condition		Dry contact port: 		
			NC & C	NO & C	
Power Off	Unit is off and no output is powered.		Close	Open	
Power On	Output is powered from Utility.		Close	Open	
	Output is powered from Battery or Solar.	Program 01 set as SUB	Battery voltage < Low DC warning voltage	Open	Close
			Battery voltage > Setting value in Program 21 or battery charging reaches floating stage	Close	Open
	Output is powered from Battery or Solar.	Program 01 is set as SBU	Battery voltage < Setting value in Program 20	Open	Close
Battery voltage > Setting value in Program 21 or battery charging reaches floating stage			Close	Open	

OPERATION

Power ON/OFF

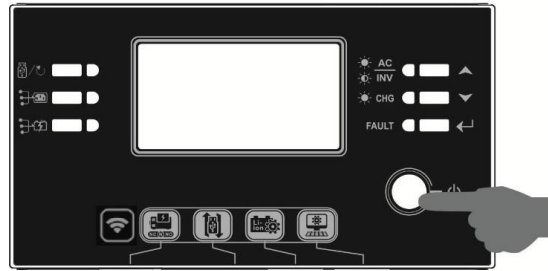

Once the unit has been properly installed and the batteries are connected well, simply press On/Off switch (located on the button of the case) to turn on the unit.

Operation and Display Panel



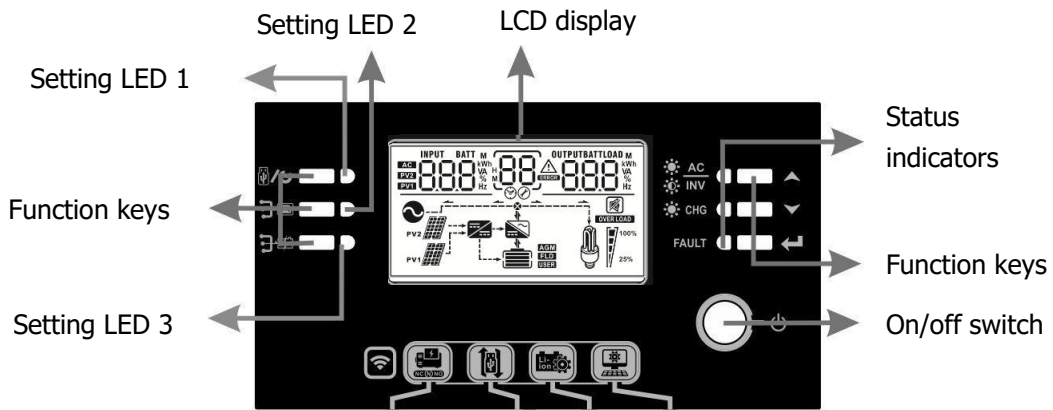



The operation and display panel, shown in below chart, is on the front panel of the inverter. It includes three indicators, four function keys and a LCD display, indicating the operating status and input/output power information.



LED Indicators







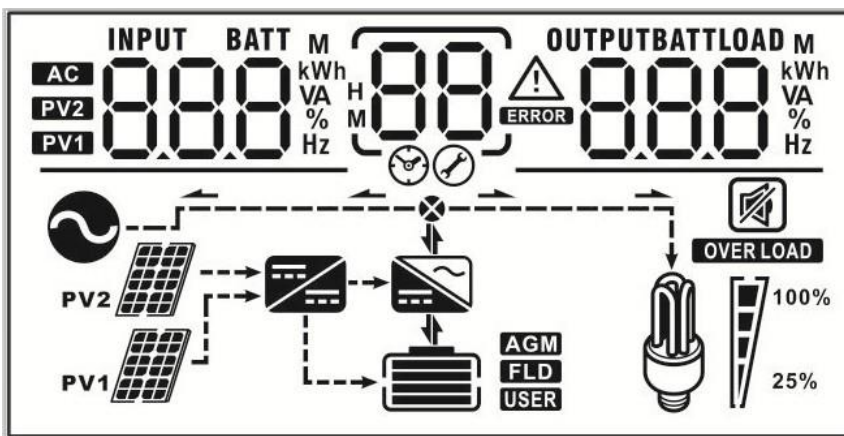

LED Indicator			Messages
Setting LED1	Green	Solid On	Reserved
Setting LED2	Green	Solid On	Reserved
Setting LED3	Green	Solid On	Reserved
Status Indicator		Solid On	Output is powered by utility in Line mode.
		Flashing	Output is powered by battery or PV in battery mode.
		Solid On	Battery is fully charged
		Flashing	Battery is charging.
FAULT	Red	Solid On	Fault mode
		Flashing	Warning mode



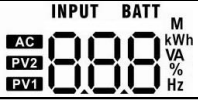







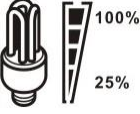

Function Keys

Function Key	Description
 ESC	Exit the setting
 Reserved	Reserved
 Reserved	Reserved
 Up	To last selection
 Down	To next selection
 Enter	To confirm/enter the selection in setting mode

LCD Display Icons



Icon	Function
Input source information	
	Indicates the AC input
	Indicates the PV1 panel input
Left digital display information	
	Indicate input voltage, input frequency, battery voltage, PV voltage, charger current
Middle digital display information	
	Indicates the setting programs.
	Indicates the warning and fault codes. Warning: Flashing  with warning code Fault: display  with fault code
Right digital display information	
	Indicate the output voltage, output frequency, load percent, load VA, load W, PV charger power, DC discharging current.
Battery information	

	Indicates battery level by 0-24%, 25-49%, 50-74% and 75-100% and charging status.			
Load information				
	Indicates overload.			
	Indicates the load level by 0-24%, 25-49%, 50-74%, and 75-100%.			
	0%~24%	25%~49%	50%~74%	75%~100%
				
Mode operation information				
	Indicates unit connects to the mains.			
	Indicates unit connects to the 1 st PV panel			
	Indicates the solar charger is working			
	Indicates the DC/AC inverter circuit is working.			
Mute operation				
	Indicates unit alarm is disabled.			

LCD Setting

After pressing and holding ENTER button for 3 seconds, the unit will enter setting mode. Press "UP" or "DOWN" button to select setting programs. And then, press "ENTER" button to confirm the selection or ESC button to exit.









Program	Description	Selectable option	
00	Exit setting mode	Escape 00 ESC	
01	Output source priority selection	SUB(default) 01 SUB	Solar energy provides power to the loads as first priority. If solar energy is not sufficient to power all connected loads, Utility energy will supply power to the loads at the same time.
		SBU 01 SBU	Solar energy provides power to the loads as first priority. If solar energy is not sufficient to power all connected loads, battery energy will supply power to the loads at the same time. Utility provides power to the loads

			only when battery voltage drops to either low-level warning voltage or the setting point in program 20 or solar and battery is not sufficient.
02	AC input voltage range	Appliances (default) 02 APL	If selected, acceptable AC input voltage range will be within 65-140VAC.
		UPS 02 UPS	If selected, acceptable AC input voltage range will be within 95-140VAC.
03	Output voltage	110Vac 03 110 ^v	120V (Default) 03 120 ^v
04	Output frequency	50Hz 04 50 ^{Hz}	60Hz (default) 04 60 ^{Hz}
05	Solar supply priority	Power to charge battery as first(default) 05 bLU	Solar energy provides power to charge battery as first priority.
		Power to the loads as first 05 LbU	Solar energy provides power to the loads as first priority.
06	Overload bypass: When enabled, the unit will transfer to line mode if overload occurs in battery mode.	Bypass disable 06 byd	Bypass enable (default) 06 byE
07	Auto restart when overload occurs	Restart disable (default) 07 Lfd	Restart enable 07 LfE
08	Auto restart when over temperature occurs	Restart disable (default) 08 tfd	Restart enable 08 tFE
09	Solar energy feed to grid configuration	Feed to grid disable(default) 09 Gfd	Solar energy feed to grid disable.

		Feed to grid enable 09 GFE	Solar energy feed to grid enable.
10	Charger source priority: To configure charger source priority	If this inverter/charger is working in Line, Standby or Fault mode, charger source can be programmed as below:	
		Solar first 10 CSO	Solar energy will charge battery as first priority. Utility will charge battery only when solar energy is not available.
		Solar and Utility (default) 10 SNU	Solar energy and utility will charge battery at the same time.
		Only Solar 10 OSO	Solar energy will be the only charger source no matter utility is available or not.
		If this inverter/charger is working in Battery mode or Power saving mode, only solar energy can charge battery. Solar energy will charge battery if it's available and sufficient.	
11	Maximum charging current: To configure total charging current for solar and utility chargers. (Max. charging current = utility charging current + solar charging current)	60A (default) 11 60 ^A	The setting range is from 10A to 120A. Increment of each click is 10A.
13	Maximum utility charging current	30A (default) 13 30 ^A	The setting range is from 10A to 120A. Increment of each click is 10A.
14	Battery type	AGM (default) 14 AGM	Flooded 14 FLD
		User-Defined 14 USE	If "User-Defined" is selected, battery charge voltage and low DC cut-off voltage can be set up in program 17, 18 and 19.
		Pylontech battery 14 PYL	If selected, programs of 11, 17, 18 and 19 will be automatically set up. No need for further setting.
		WECO battery 14 WEC	If selected, programs of 11, 17, 18, 19 and 20 will be auto-configured per battery supplier recommended. No need for further adjustment. Programs of 20 and 21 parameters refer to SOC of battery.

14	Battery type	Soltaro battery 14 SOL	If selected, programs of 11, 17, 18 and 19 will be automatically set up. No need for further setting.
		LIb-protocol 14 LIb	Select " LIb" if using Lithium battery compatible to Lib protocol. If selected, programs of 11, 17, 18 and 19 will be automatically set up. No need for further setting.
		3 rd party Lithium battery 14 LIC	If selected, programs of 11, 17, 18 and 19 will be automatically set up. No need for further setting. Please contact the battery supplier for installation procedure.
17	Bulk charging voltage (C.V voltage)	Default setting: 56.4V CU 17 BATT 56.4 ^v	
			If self-defined is selected in program 14, this program can be set up. Setting range is from 48.0V to 64.0V. Increment of each click is 0.1V.
18	Floating charging voltage	Default setting: 54.0V FLU 18 BATT 54.0 ^v	
			If self-defined is selected in program 14, this program can be set up. Setting range is from 48.0V to 64.0V. Increment of each click is 0.1V.
19	Low DC cut off battery voltage setting	Default setting: 40.8V COU 19 BATT 40.8 ^v	
			If self-defined is selected in program 14, this program can be set up. Setting range is from 40.8V to 48.0V. Increment of each click is 0.1V. Low DC cut-off voltage will be fixed to setting value no matter what percentage of load is connected.
20	Battery stop discharging voltage when grid is available	default setting: 46V 20 BATT 46 ^v	Setting range is from 44V to 51V and increment of each click is 1V.
		5% (default) WEC 20 BATT 5 [%]	If "WECO battery" is selected in program 14, the parameter will be fixed at 5% SOC of battery.

21	Battery stop charging voltage when grid is available	Battery fully charged 21 ^{BATT} FUL	The setting range is from 48V to 58V and increment of each click is 1V.
		Default setting: 54V 21 ^{BATT} 54.0 ^v	
		10% (default) WEC 21 ^{BATT} 10%	If "WECO battery" is selected in program 14, this parameter will refer to the SOC of battery and adjustable from 10% to 100%. Increment of each click is 5%.
22	Auto return to default display screen	Return to default display screen (default) 22 ESP	If selected, no matter how users switch display screen, it will automatically return to default display screen (Input voltage /output voltage) after no button is pressed for 1 minute.
		Stay at latest screen 22 FEP	If selected, the display screen will stay at latest screen user finally switches.
23	Backlight control	Backlight on (default) 23 LON	Backlight off 23 LOF
		Alarm on (default) 24 BON	Alarm off 24 BOF
24	Alarm control	Alarm on (default) 24 BON	Alarm off 24 BOF
		Alarm on (default) 25 AON	Alarm off 25 AOF
25	Beeps while primary source is interrupted	Alarm on (default) 25 AON	Alarm off 25 AOF
		Record enable 27 FEN	Record disable (default) 27 FDS
27	Record Fault code	Record enable 27 FEN	Record disable (default) 27 FDS
		Single: When selected, the unit is used in single operation. 28 ^{OUTPUT} SIO	Parallel: When selected, this inverter is operated in parallel system. The maximum parallel unit is 9. 28 ^{OUTPUT} PAR
28	AC output mode *This setting is only available when the inverter is in standby mode (Switch off).	Single: When selected, the unit is used in single operation. 28 ^{OUTPUT} SIO	Parallel: When selected, this inverter is operated in parallel system. The maximum parallel unit is 9. 28 ^{OUTPUT} PAR
		Not reset(Default) 29	Reset 29 FSE
29	Reset PV energy storage	Not reset(Default) 29	Reset 29 FSE

<p>30</p>	<p>Start charging time for AC charger</p>	<p>00:00 (Default)</p>  <p>The setting range of start charging time for AC charger is from 00:00 to 23:00, increment of each click is 1 hour.</p>
<p>31</p>	<p>Stop charging time for AC charger</p>	<p>00:00 (Default)</p>  <p>The setting range of stop charging time for AC charger is from 00:00 to 23:00, increment of each click is 1 hour.</p>
<p>32</p>	<p>Scheduled time for AC output on</p>	<p>00:00 (Default)</p>  <p>The setting range of scheduled Time for AC output on is from 00:00 to 23:00, increment of each click is 1 hour.</p>
<p>33</p>	<p>Scheduled time for AC output off</p>	<p>00:00(Default)</p>  <p>The setting range of scheduled Time for AC output off is from 00:00 to 23:00, increment of each click is 1 hour.</p>
<p>95</p>	<p>Time setting – Minute</p>	 <p>For minute setting, the range is from 00 to 59.</p>
<p>96</p>	<p>Time setting – Hour</p>	 <p>For hour setting, the range is from 00 to 23.</p>
<p>97</p>	<p>Time setting– Day</p>	 <p>For day setting, the range is from 00 to 31.</p>
<p>98</p>	<p>Time setting– Month</p>	 <p>For month setting, the range is from 01 to 12.</p>
<p>99</p>	<p>Time setting – Year</p>	 <p>For year setting, the range is from 16 to 99.</p>

Display Setting

The LCD display information will be switched in turns by pressing "UP" or "DOWN" key. The selectable information is switched as below order: input voltage, input frequency, PV voltage, charging current, battery voltage, output voltage, output frequency, load percentage, load in Watt, load in VA, load in Watt, DC discharging current, main board firmware version and SCC firmware version.

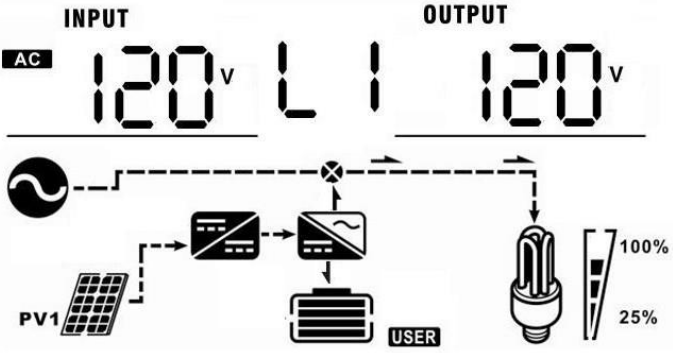
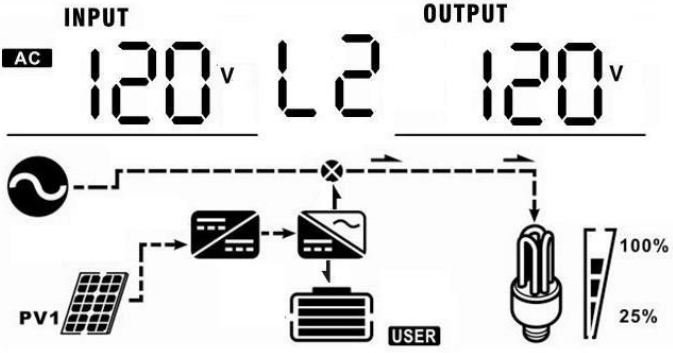
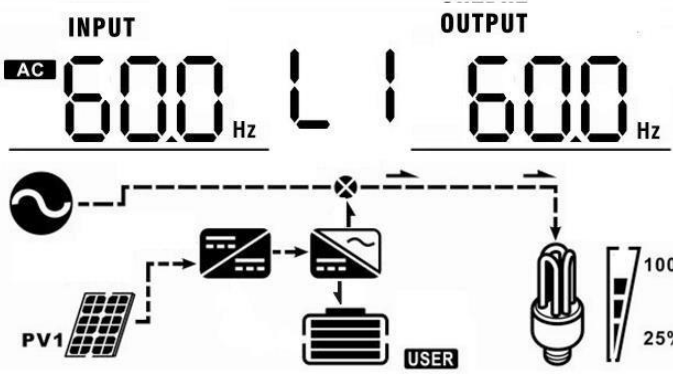
Select item	LCD display
Input1 voltage and output1 voltage (Default Display Screen)	Input1 Voltage=120V, output1 voltage=120V  <p>The diagram shows a power system with AC input, PV1 input, a battery, and a user load. The output is connected to a light bulb and a load percentage indicator showing 100% and 25%.</p>
Input2 voltage and output2 voltage (Default Display Screen)	Input2 Voltage=120V, output2 voltage=120V  <p>The diagram shows a power system with AC input, PV1 input, a battery, and a user load. The output is connected to a light bulb and a load percentage indicator showing 100% and 25%.</p>
Input1 frequency and output1 frequency	Input1 frequency=60.0Hz, output1 frequency=60.0Hz  <p>The diagram shows a power system with AC input, PV1 input, a battery, and a user load. The output is connected to a light bulb and a load percentage indicator showing 100% and 25%.</p>

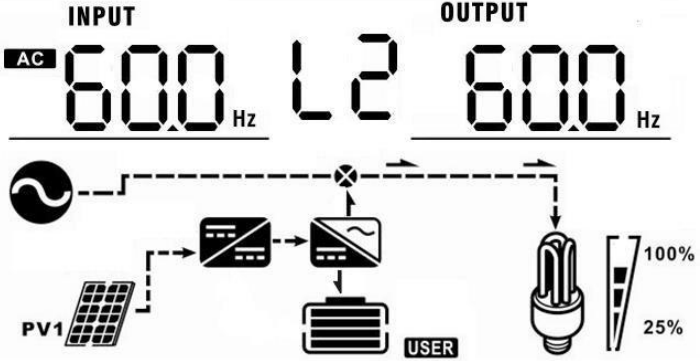
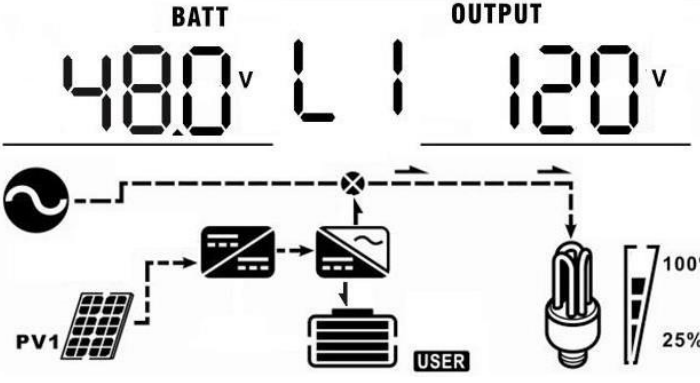
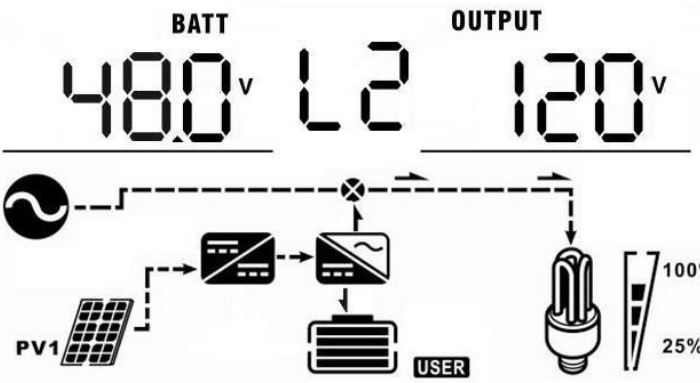
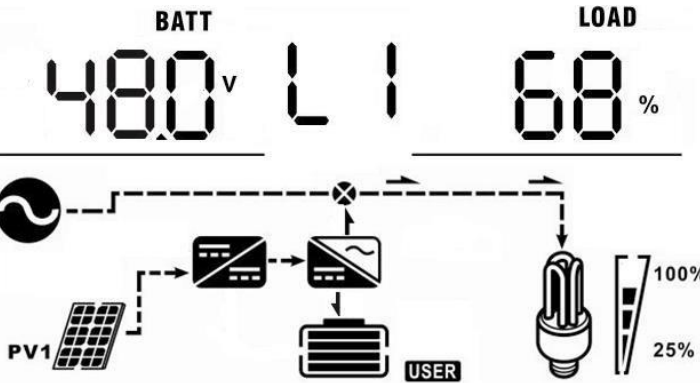
<p>Input2 frequency and output2 frequency</p>	<p>Input2 frequency=60.0Hz, output2 frequency=60.0Hz</p> 
<p>Battery voltage and output1 voltage</p>	<p>Battery Voltage=48.0V, output1 voltage=120V</p> 
<p>Battery voltage and output2 voltage</p>	<p>Battery Voltage=48.0V, output2 voltage=120V</p> 
<p>Battery voltage and load1 percentage</p>	<p>Battery Voltage=48.0V, load1 percentage = 68%</p> 

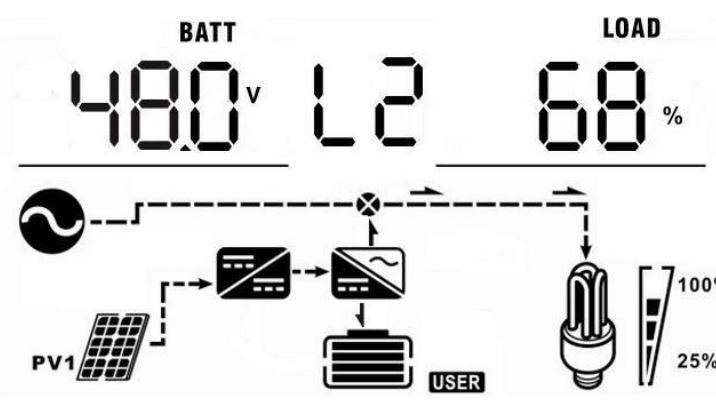
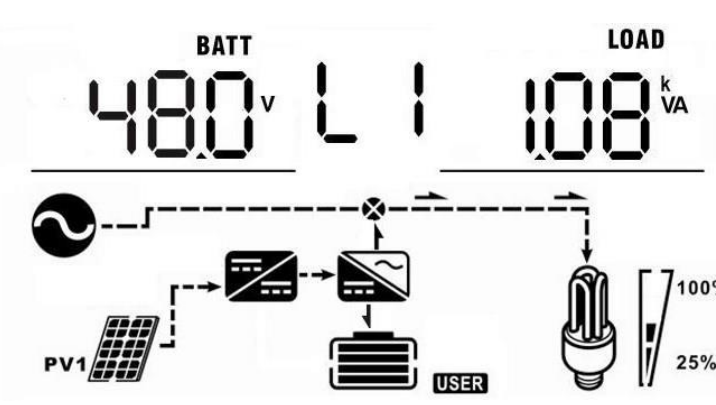
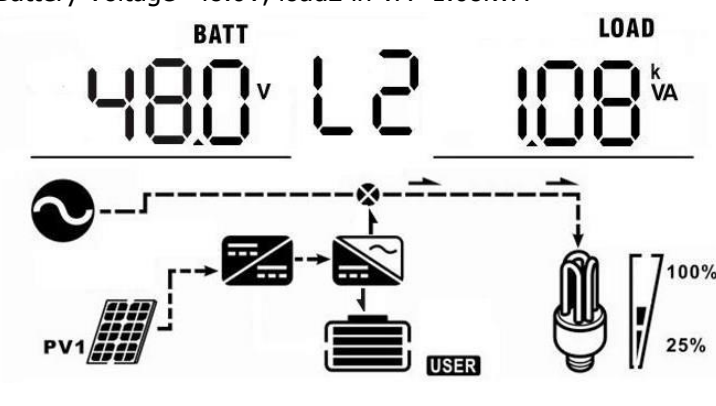
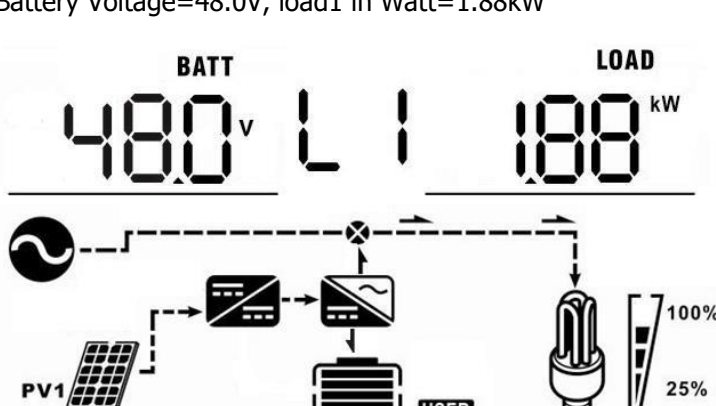

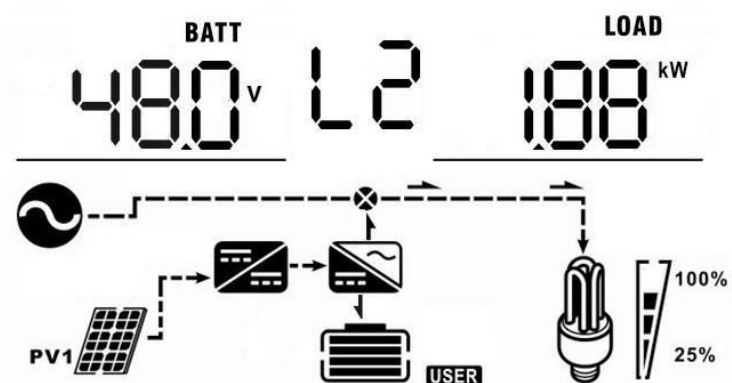
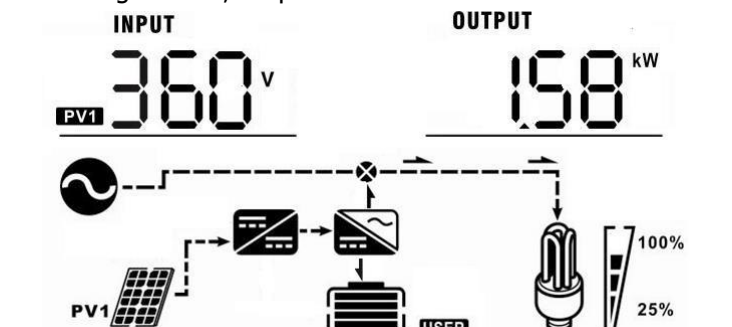
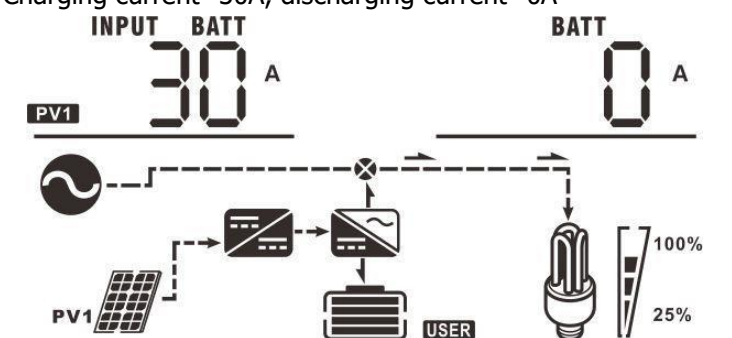
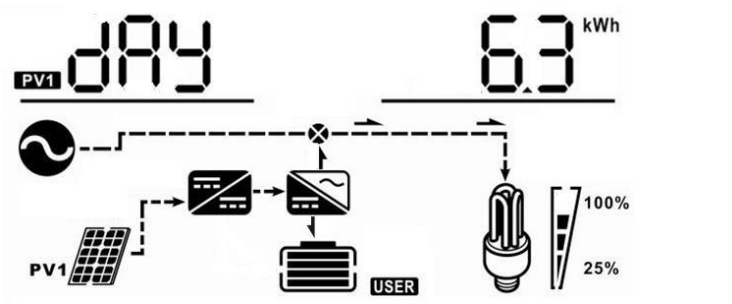
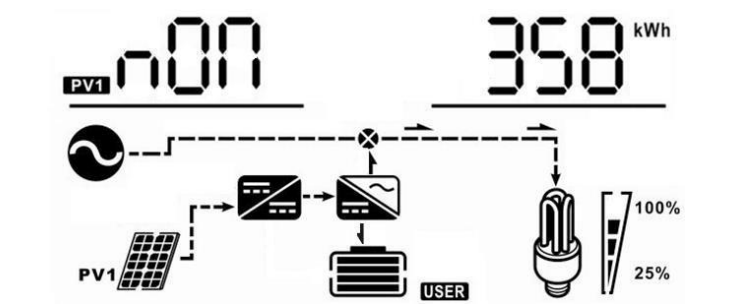

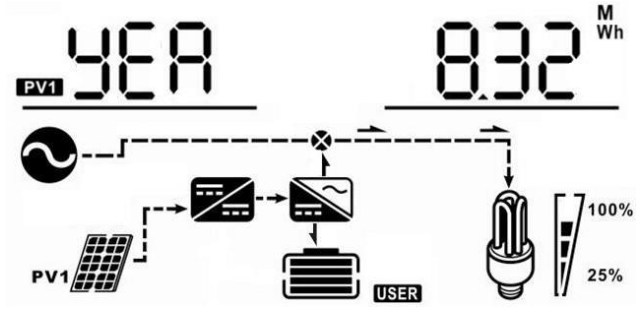
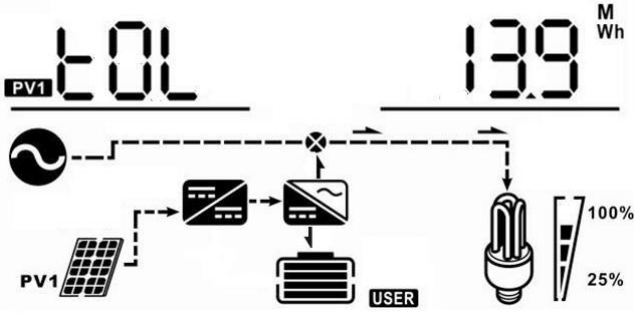
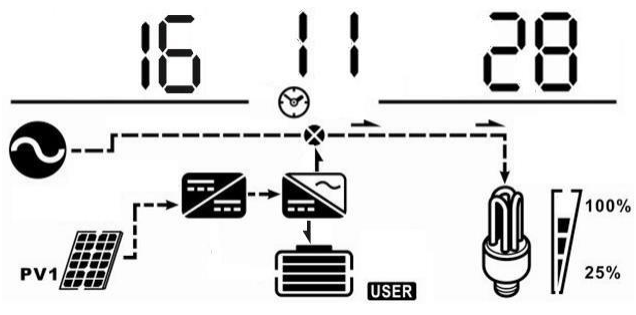
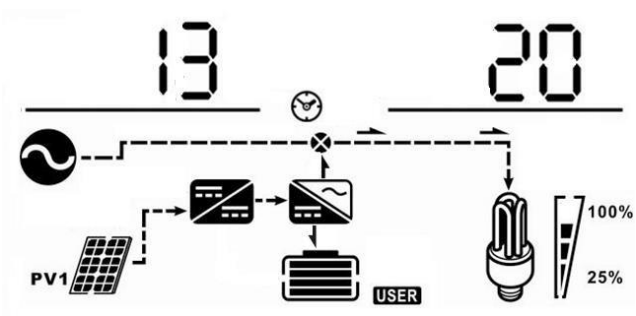
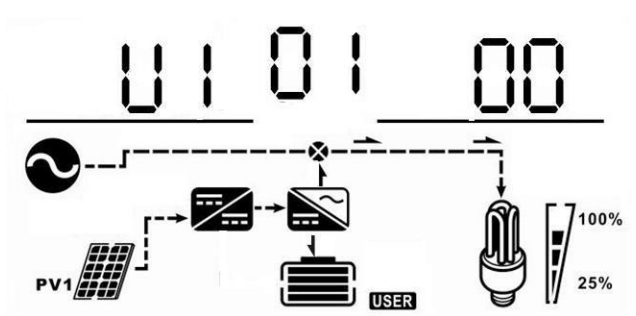

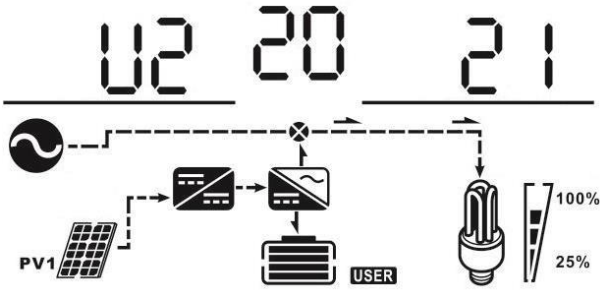
<p>Battery voltage and load2 percentage</p>	<p>Battery Voltage=48.0V, load2 percentage = 68%</p> 
<p>Battery voltage and load1 in VA</p>	<p>Battery Voltage=48.0V, load1 in VA=1.08kVA</p> 
<p>Battery voltage and load2 in VA</p>	<p>Battery Voltage=48.0V, load2 in VA=1.08kVA</p> 
<p>Battery voltage and load1 in Watt</p>	<p>Battery Voltage=48.0V, load1 in Watt=1.88kW</p> 

<p>Battery voltage and load2 in Watt</p>	<p>Battery Voltage=48.0V, load2 in Watt=1.88kW</p> 
<p>PV1 voltage and PV power</p>	<p>PV1 Voltage=360V, PV power=1.58kW</p> 
<p>Charger current and DC discharging current</p>	<p>Charging current=30A, discharging current=0A</p> 
<p>PV energy generated today</p>	<p>Today energy = 6.3kWh</p> 
<p>PV energy generated this month</p>	<p>This month energy = 358kWh</p> 

<p>PV energy generated this year</p>	<p>This year energy = 8.32MWh</p>  <p>The display shows '4EA' on the left and '8.32 MWh' on the right. Below is a schematic of a PV system: a PV1 panel, a solar inverter, a transformer, a meter, a user load, and a light bulb. A gauge indicates 100% and 25% levels.</p>
<p>PV energy generated totally</p>	<p>Total energy = 13.9MWh</p>  <p>The display shows 'EOL' on the left and '13.9 MWh' on the right. Below is a schematic of a PV system: a PV1 panel, a solar inverter, a transformer, a meter, a user load, and a light bulb. A gauge indicates 100% and 25% levels.</p>
<p>Real date</p>	<p>Real date Nov 28, 2016.</p>  <p>The display shows '16 11 28' representing the date. Below is a schematic of a PV system: a PV1 panel, a solar inverter, a transformer, a meter, a user load, and a light bulb. A gauge indicates 100% and 25% levels.</p>
<p>Real time</p>	<p>Real time 13:20.</p>  <p>The display shows '13 20' representing the time. Below is a schematic of a PV system: a PV1 panel, a solar inverter, a transformer, a meter, a user load, and a light bulb. A gauge indicates 100% and 25% levels.</p>
<p>Main CPU version checking.</p>	<p>Main CPU version 00001.00</p>  <p>The display shows '0101 00' representing the CPU version. Below is a schematic of a PV system: a PV1 panel, a solar inverter, a transformer, a meter, a user load, and a light bulb. A gauge indicates 100% and 25% levels.</p>

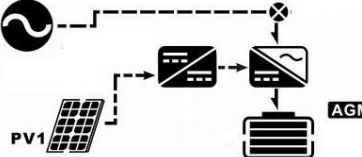
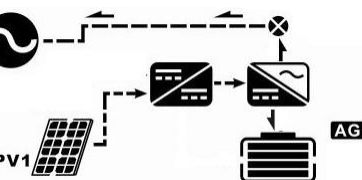

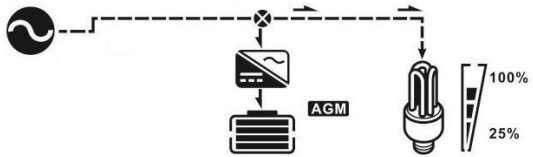





<p>Secondary CPU version checking.</p>	<p>Secondary CPU version 00020.21</p> 
--	--

Operating Mode Description













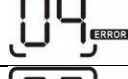

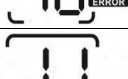
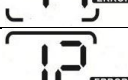

Operating mode	Behaviors	LCD display
<p>Standby mode</p> <p>Note:</p> <p>*Standby mode: The inverter is not turned on yet but at this time, the inverter can charge battery without AC output.</p> <p>*Power saving mode: If enabled, the output of inverter will be off when connected load is pretty low or not detected.</p>	<p>No output power, solar or utility charger available</p>	<p>Battery is charged by utility.</p>  <p>Battery is charged by PV energy.</p>  <p>Battery is charged by utility and PV energy.</p>  <p>Battery is charged by PV energy and feed PV energy to grid.</p>  <p>No charging.</p> 
<p>Line mode</p>	<p>Output power from utility. Charger available</p>	<p>Utility charges battery and provides power to load.</p>  <p>Utility and battery power provide power to load.</p> 
<p>Line mode</p>	<p>Output power from utility. Charger available</p>	<p>PV energy, battery power and utility provide power to load.</p> 

	<p>Output power from utility. Charger available</p>	<p>PV energy and utility charge battery, and utility provides power to load.</p>
		<p>PV energy charges battery, utility and PV energy provide power to the load.</p>
		<p>PV energy charges battery, PV energy provides power to the load and feeds remaining energy to the grid.</p>
<p>Battery mode</p>		<p>Output power from battery or PV</p>
	<p>PV energy charges battery and provides power to the load.</p>	
	<p>Battery provides power to the load.</p>	
<p>Only PV mode</p>	<p>Output power from PV</p>	<p>PV provides power to the load.</p>
<p>Fault mode</p> <p>Note: *Fault mode: Errors are caused by inside circuit error or external reasons such as over temperature, output short circuited and so on.</p>	<p>No output, no charging.</p>	<p>No charging.</p>

Warning Indicator

Warning Code	Warning Event	Icon flashing
01	Fan locked	
02	Over temperature	
03	Battery over charged	
04	Low battery	
07	Overload	
10	Inverter power derating	
15	PV is weak	
19	Battery is not connected	

Faults Reference Code

Fault Code	Fault Event	Icon on
01	Fan is locked.	
02	Over temperature	
03	Battery voltage is too high.	
04	Battery voltage is too low.	
05	Output is short circuited.	
06	Output voltage is abnormal.	
07	Overload time out.	
08	Bus voltage is too high.	
09	Bus soft start failure.	
10	PV current is over.	
11	PV voltage is over.	
12	Charge current is over.	
51	Over current or surge	
52	Bus voltage is too low.	
53	Inverter soft start failure.	
55	Over DC offset in AC output	
56	Battery is not connected.	
57	Current sensor failure.	
58	Output voltage is too low.	

SPECIFICATIONS

MODEL	BluePower TP6048
RATED OUTPUT POWER	6000W
PV INPUT (DC)	
Max. PV Power	6000W
Max. Input voltage (Maximum PV open voltage)	450 VDC
Max. DC Power MPPT range	222 VDC~430 VDC
Working MPPT range	120 VDC~430 VDC
Max. DC Input current / per string	27A
Number of MPP Tracker	1
GRID-TIE OPERATION	
GRID OUTPUT (AC)	
Nominal Output Voltage	110-120VAC (L-N) / 220-240VAC (L1-L2)
Feed-in Grid Voltage Range	97~121 VAC For 110 Vac model (IEEE 1547) 106~132 VAC For 120 Vac model (IEEE 1547)
Feed-in Grid Frequency Range	59.3~60.5Hz For 60Hz (IEEE 1547)
Nominal Output Current	27.3A (for 110VAC) 25A (for 120VAC)
Power Factor Range	>0.99
Maximum Conversion Efficiency (DC/AC)	95%
OFF-GRID, HYBRID OPERATION	
GRID INPUT	
Acceptable Input Voltage Range	65 - 140 VAC (Appliances) or 95 - 140 VAC (UPS)
Frequency Range	50 Hz/60 Hz (Auto sensing)
Rating of AC Transfer Relay	40A
BATTERY MODE OUTPUT (AC)	
Nominal Output Voltage	110-120VAC (L-N) / 220-240VAC (L1-L2)
Output Waveform	Pure Sine Wave
Efficiency (DC to AC)	93%
BATTERY & CHARGER	
Nominal DC Voltage	48 VDC
Maximum Charging Current (from Grid)	120A
Maximum Charging Current (from PV)	120A
Maximum Charging Current	120A
GENERAL	
Dimension, D X W X H (inch)	5.51X14.96X25.59
Net Weight (lb)	73.2
INTERFACE	
Parallel-able	Yes
Communication	RS232/Dry-Contact/Wi-Fi
ENVIRONMENT	
Humidity	0 ~ 90% RH (No condensing)
Operating Temperature	-10°C to 50°C

TROUBLE SHOOTING

Problem	LCD/LED/Buzzer	Explanation / Possible cause	What to do
Unit shuts down automatically during startup process.	LCD/LEDs and buzzer will be active for 3 seconds and then complete off.	The battery voltage is too low (<1.91V/Cell)	1. Re-charge battery. 2. Replace battery.
No response after power on.	No indication.	1. The battery voltage is far too low. (<1.4V/Cell) 2. Battery polarity is connected reversed.	1. Check if batteries and the wiring are connected well. 2. Re-charge battery. 3. Replace battery.
Mains exist but the unit works in battery mode.	Input voltage is displayed as 0 on the LCD and green LED is flashing.	Input protector is tripped	Check if AC breaker is tripped and AC wiring is connected well.
	Green LED is flashing.	Insufficient quality of AC power. (Shore or Generator)	1. Check if AC wires are too thin and/or too long. 2. Check if generator (if applied) is working well or if input voltage range setting is correct. (UPS→Appliance)
	Green LED is flashing.	Set "Solar First" as the priority of output source.	Change output source priority to Utility first.
When the unit is turned on, internal relay is switched on and off repeatedly.	LCD display and LEDs are flashing	Battery is disconnected.	Check if battery wires are connected well.
Buzzer beeps continuously and red LED is on.	Fault code 07	Overload error. The inverter is overload 110% and time is up.	Reduce the connected load by switching off some equipment.
	Fault code 05	Output short circuited.	Check if wiring is connected well and remove abnormal load.
		Temperature of internal converter component is over 120°C.	Check whether the air flow of the unit is blocked or whether the ambient temperature is too high.
	Fault code 02	Internal temperature of inverter component is over 100°C.	Check whether the air flow of the unit is blocked or whether the ambient temperature is too high.
	Fault code 03	Battery is over-charged.	Return to repair center.
		The battery voltage is too high.	Check if spec and quantity of batteries are meet requirements.
	Fault code 01	Fan fault	Replace the fan.
	Fault code 06/58	Output abnormal (Inverter voltage below than 190Vac or is higher than 260Vac)	1. Reduce the connected load. 2. Return to repair center
	Fault code 08/09/53/57	Internal components failed.	Return to repair center.
	Fault code 10	Surge	Restart the unit, if the error happens again, please return to repair center.
	Fault code 12	DC/DC over current or surge.	
	Fault code 51	Over current or surge.	
	Fault code 52	Bus voltage is too low.	
	Fault code 55	Output voltage is unbalanced.	
Fault code 56	Battery is not connected well or fuse is burnt.	If the battery is connected well, please return to repair center.	
Fault code 11	Solar input voltage is more than 450V.	Solar input voltage is more than 450V.	

Appendix I: Parallel function

1. Introduction

This inverter can be used in parallel in only split phase equipment.

- Maximum nine units work together to support split phase equipment. The supported maximum output power is 54KW/54KVA.

NOTE: If this unit is bundled with share current cable and parallel cable, this inverter is default supported parallel operation. You may skip section 3. If not, please purchase parallel kit and install this unit by following instruction from professional technical personnel in local dealer.

2. Package Contents

In parallel kit, you will find the following items in the package:



Parallel communication cable



Current sharing cable

3. Parallel board installation

Step 1: Remove wire cover by unscrewing all screws.

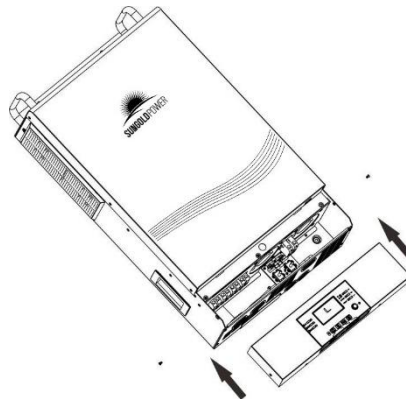

Step 2: Remove two screws as below chart and remove 2-pin and 14-pin cables. Take out the board under the communication board.

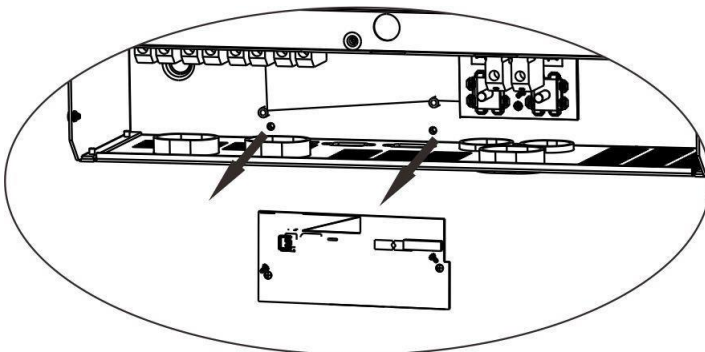

Step 3: Remove two screws as below chart to take out cover of parallel communication.

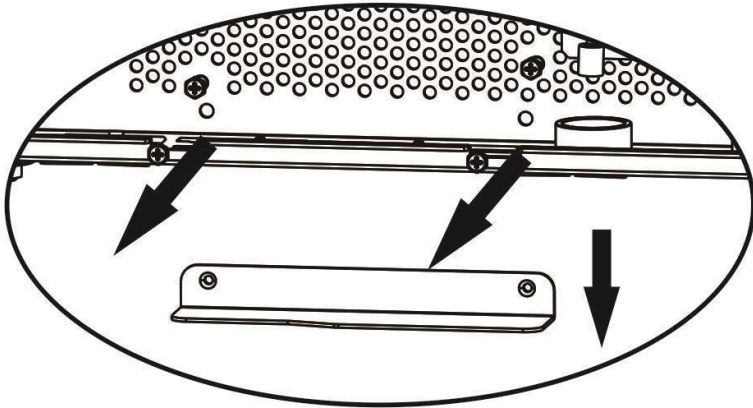

Step 4: Install new parallel board with 2 screws tightly.

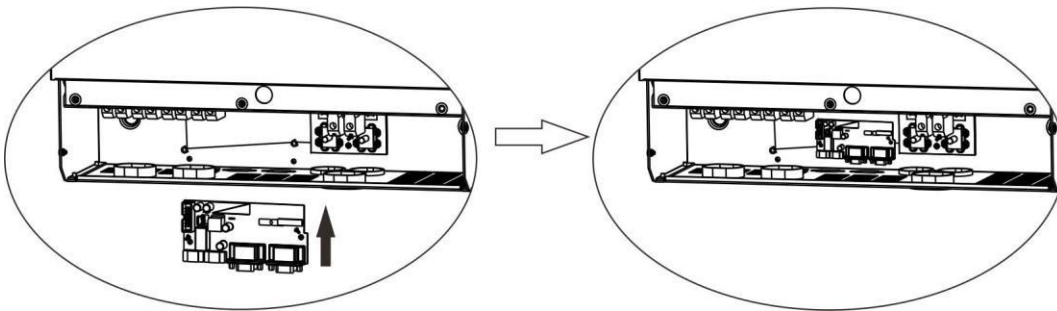

Step 6: Connect 2-pin to original position.

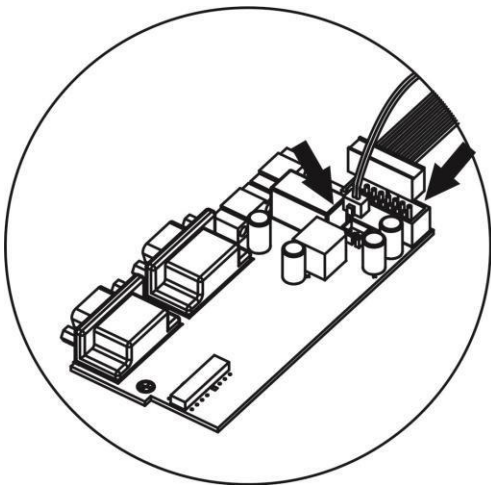

Step 7: Put communication board back to the unit.

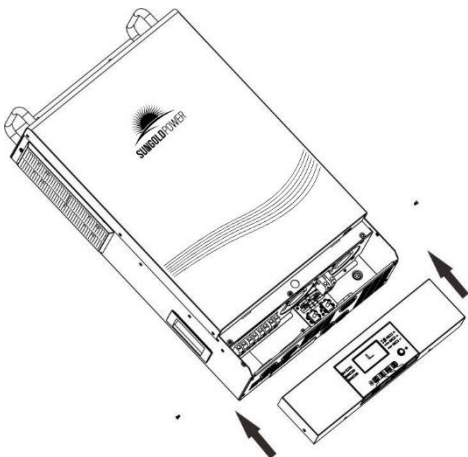

Step 8: Put wire cover back to the unit. Now the inverter is providing parallel operation function.

4. Mounting the Unit

When installing multiple units, please follow below chart.

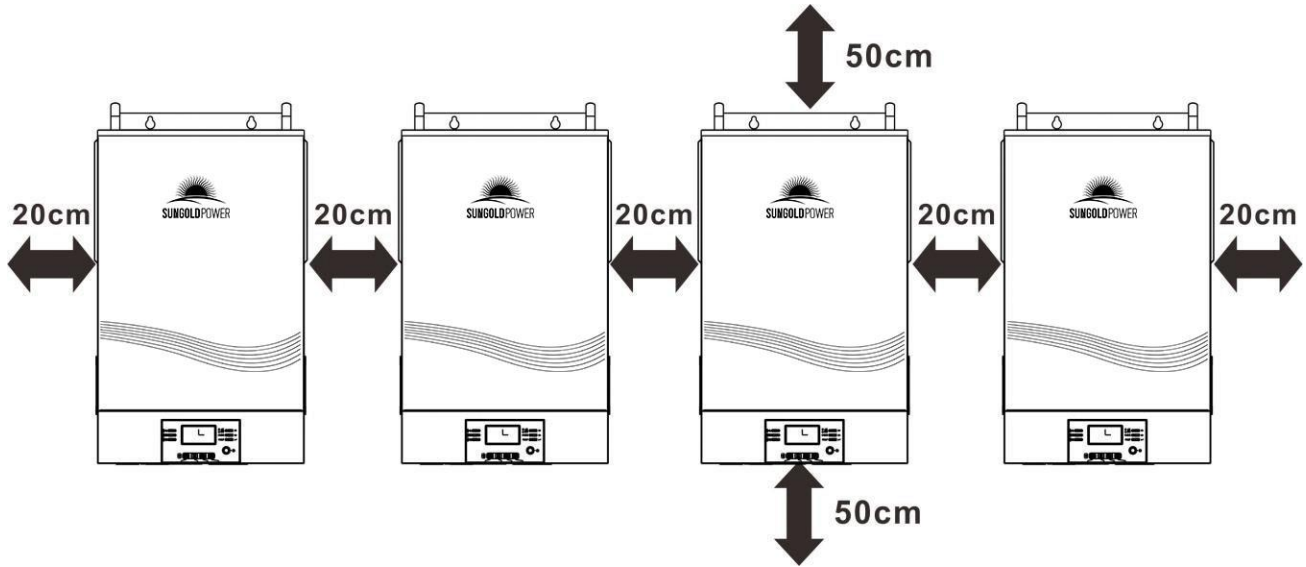

NOTE: For proper air circulation to dissipate heat, allow a clearance of approx. 20 cm to the side and approx. 50 cm above and below the unit. Be sure to install each unit in the same level.

5. Wiring Connection

NOTICE: It's requested to connect to battery for parallel operation.

The cable size of each inverter is shown as below:

Recommended battery cable and terminal size for each inverter:

Model	Wire Size	Ring Terminal			Torque value
		Cable mm ²	Dimensions		
			D (mm)	L (mm)	
TP6048	1*2AWG	38	6.4	33.2	2~ 3 Nm

Ring terminal:

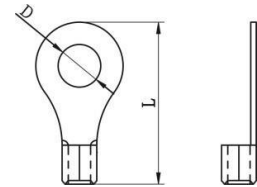

WARNING: Be sure the length of all battery cables is the same. Otherwise, there will be voltage difference between inverter and battery to cause parallel inverters not working.

Recommended AC input and output cable size for each inverter:

Model	AWG no.	Torque
BluePower TP6048	10 AWG	1.2~1.6Nm

You need to connect the cables of each inverter together. Take the battery cables for example: You need to use a connector or bus-bar as a joint to connect the battery cables together, and then connect to the battery terminal. The cable size used from joint to battery should be X times cable size in the tables above. "X" indicates the number of inverters connected in parallel.

Regarding AC input and output, please also follow the same principle.

WARNING!! Make sure all output N wires of each inverter must be connected all the time. Otherwise, it will cause inverter fault in error code #72.

CAUTION!! Please install the breaker at the battery and AC input side. This will ensure the inverter can be securely disconnected during maintenance and fully protected from over current of battery or AC input. The recommended mounted location of the breakers is shown in the figures in 5-1 and 5-2.

Recommended breaker specification of battery for each inverter:

Model	1 unit*
BluePower TP6048	150A/70VDC

*If you want to use only one breaker at the battery side for the whole system, the rating of the breaker should

be X times current of 1 unit. "X" indicates the number of inverters connected in parallel.

Recommended breaker specification of AC input with single phase:

Model	2 units	3 units	4 units	5 units	6 units	7 units	8 units	9 units
TP6048	80A/ 230VAC	120A/ 230VAC	160A/ 230VAC	200A/ 230VAC	240A/ 230VAC	280A/ 230VAC	320A/ 230VAC	360A/ 230VAC

Note1: Also, you can use 50A for BluePower TP6048 for only 1 unit and install one breaker at its AC input in each inverter. **Note2:** Regarding split phase system, you can use 3-pole breaker directly and the rating of the breaker should be compatible with the phase current limitation from the phase with maximum units

Recommended battery capacity

Inverter parallel numbers	2	3	4	5	6	7	8	9
Battery Capacity for 6KW	400AH	600AH	800AH	1000AH	1200AH	1400AH	1600AH	1800AH

WARNING! Be sure that all inverters will share the same battery bank. Otherwise, the inverters will transfer to fault mode.

6. Parallel Operation

Two inverters in parallel:

Power Connection

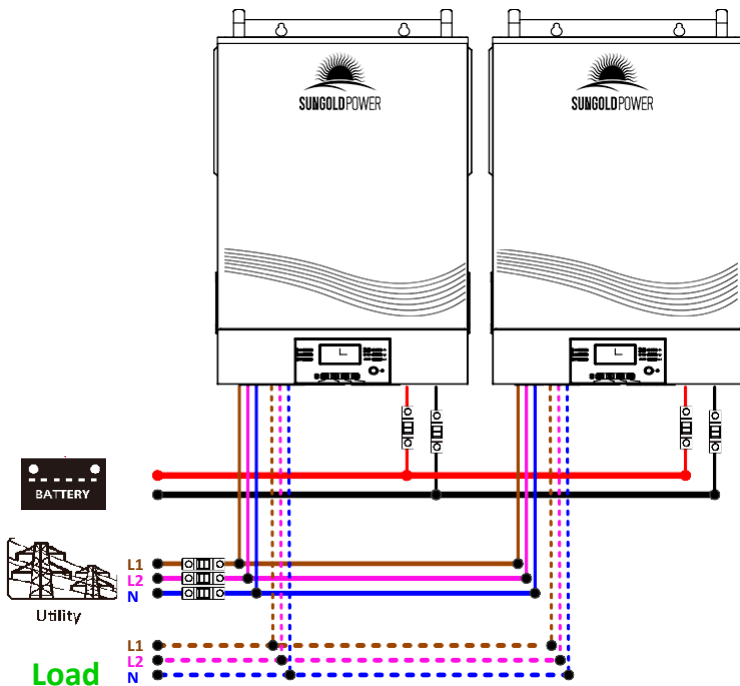

Communication Connection

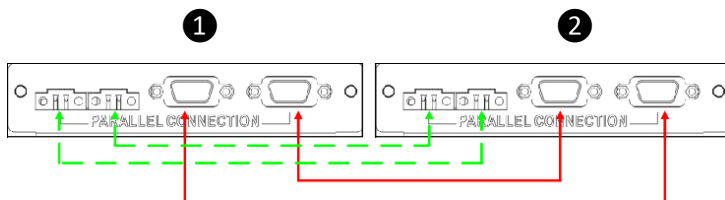

Three inverters in parallel:

Power Connection

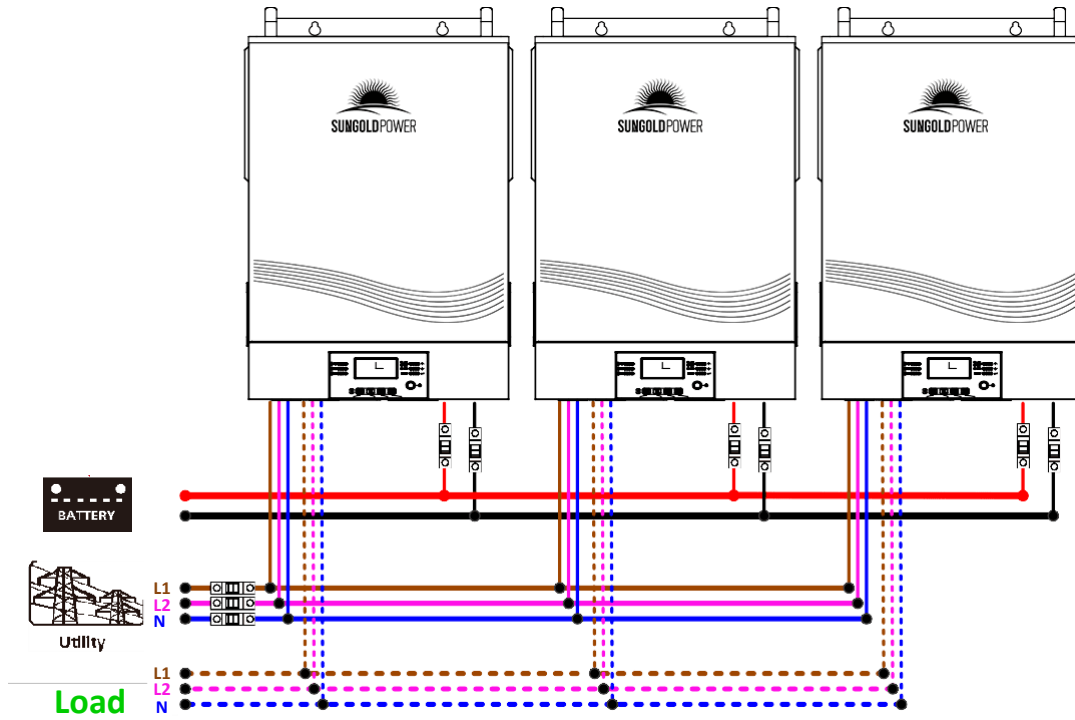

Communication Connection

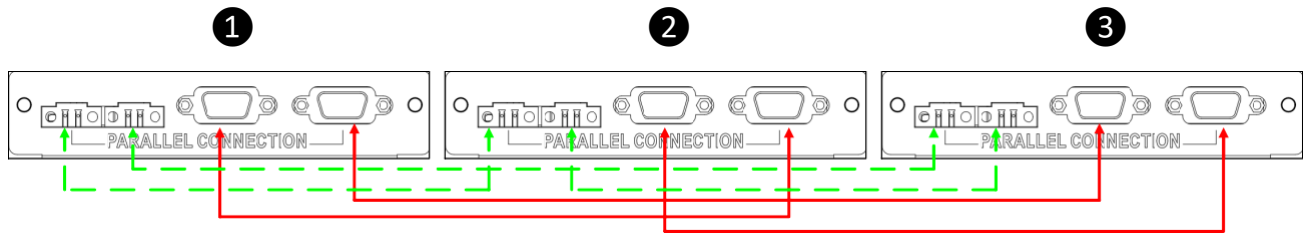

Four inverters in parallel:

Power Connection

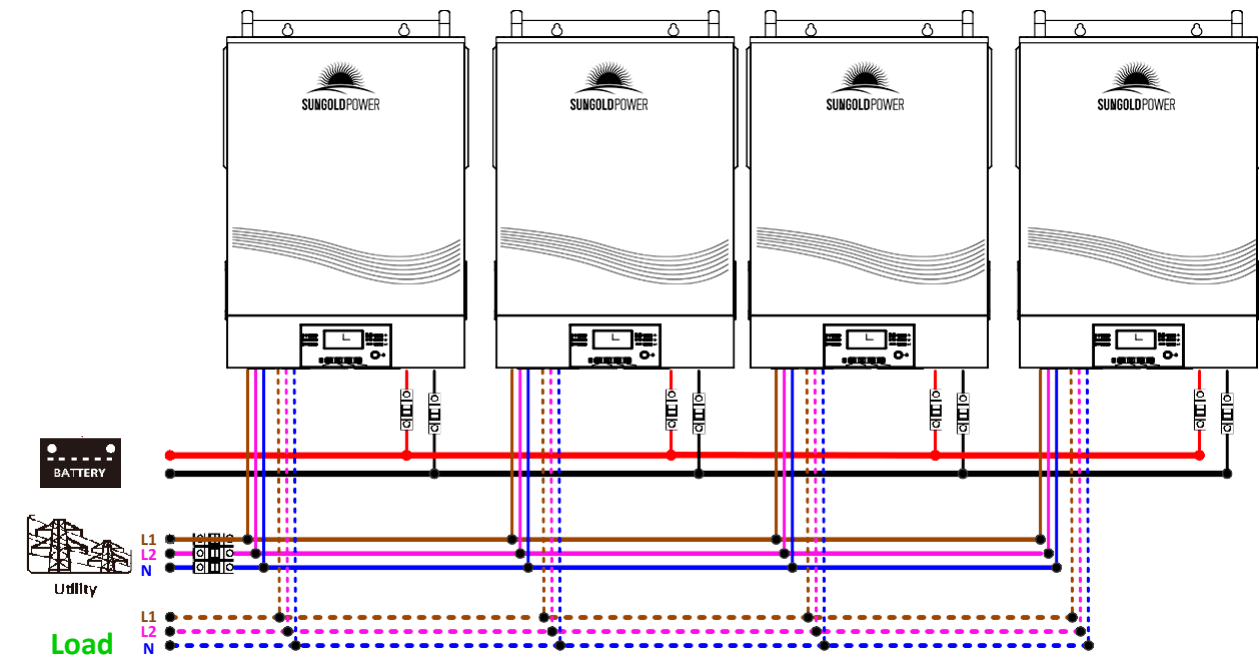

Communication Connection

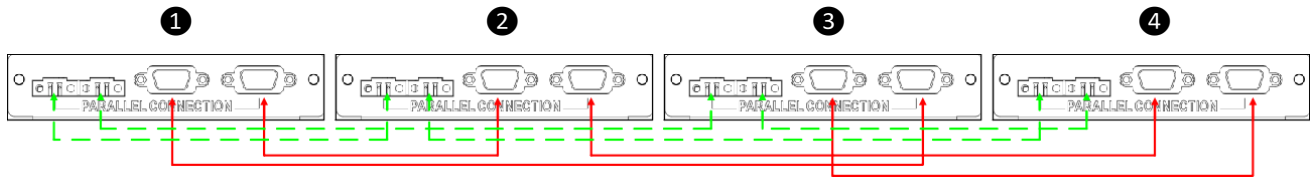

Five inverters in parallel:

Power Connection

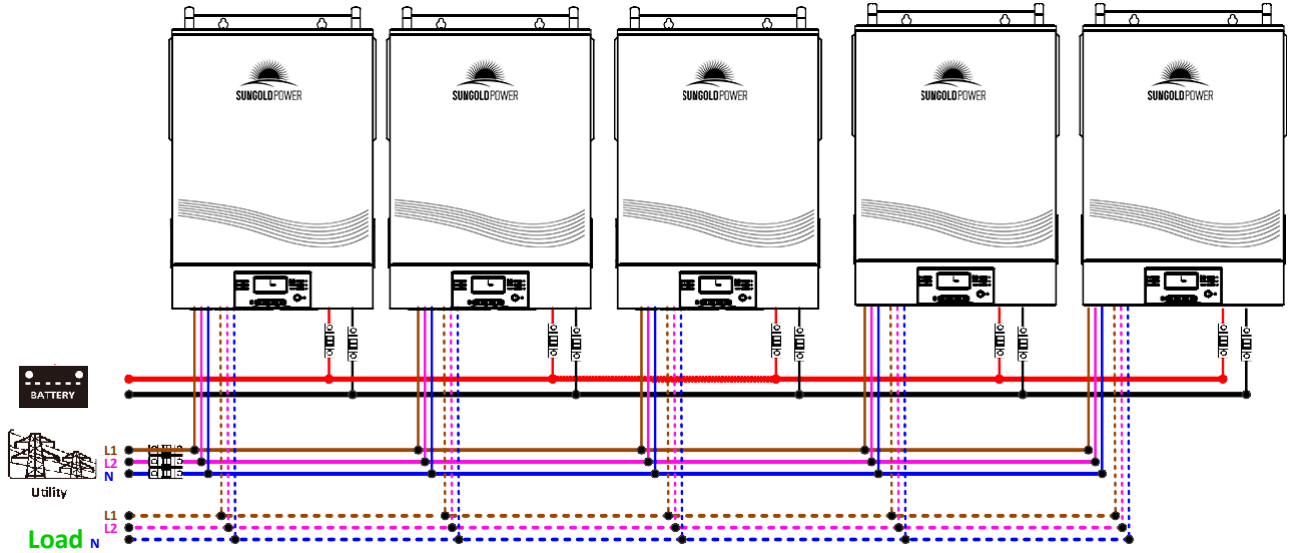

Communication Connection

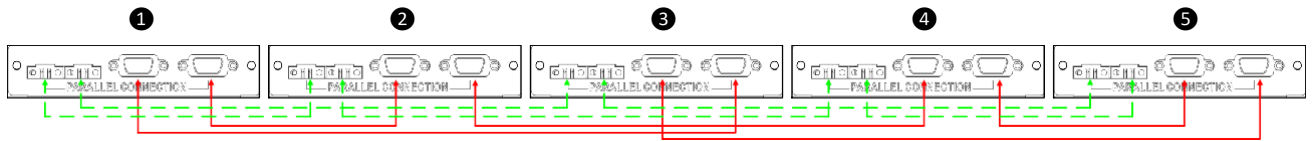

Six inverters in parallel:

Power Connection

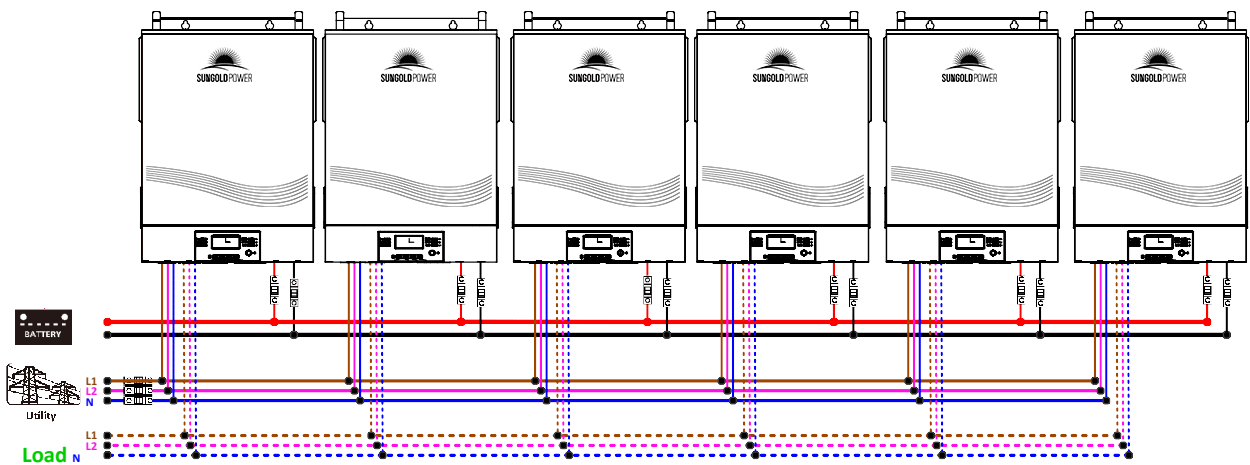

Communication Connection

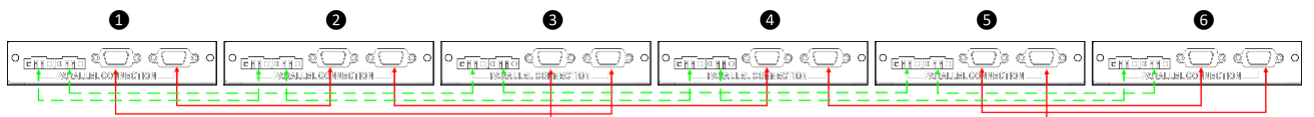

Seven inverters in parallel:

Power Connection

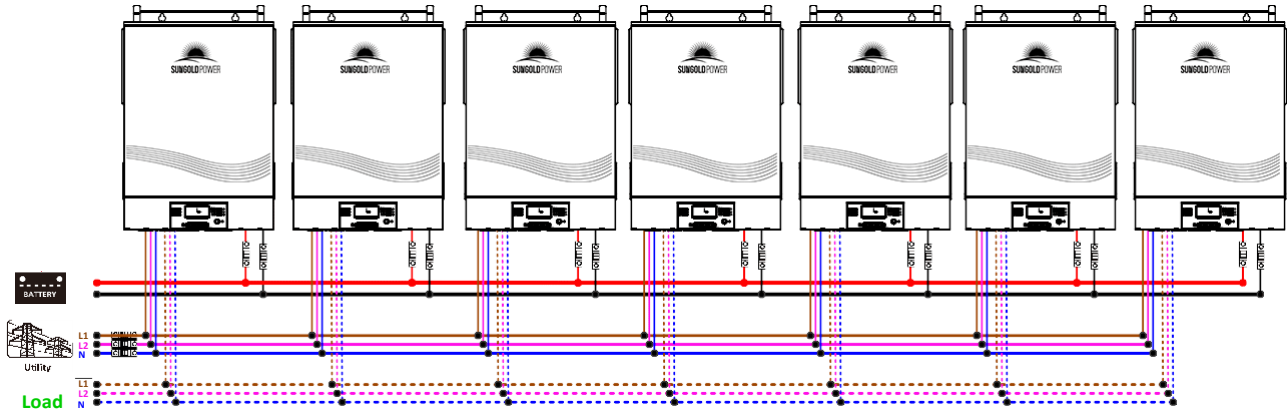

Communication Connection



Eight inverters in parallel:

Power Connection

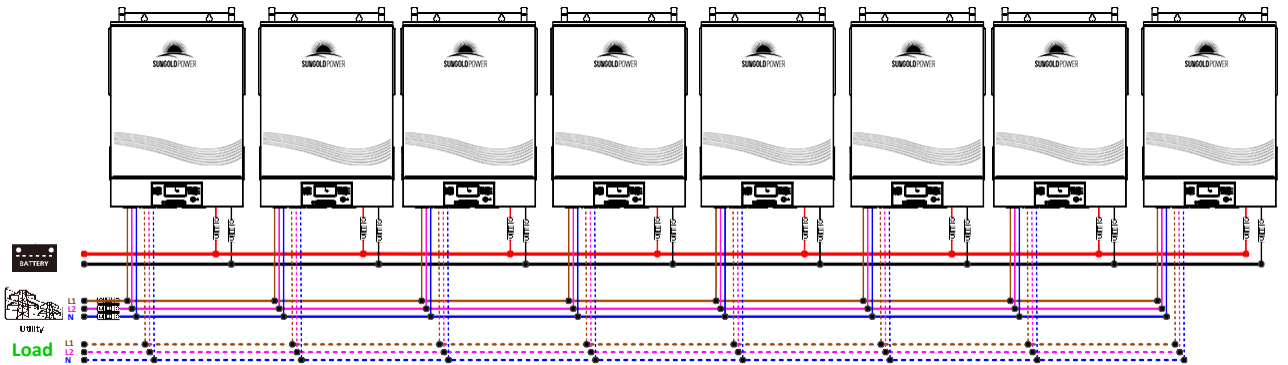

Communication Connection

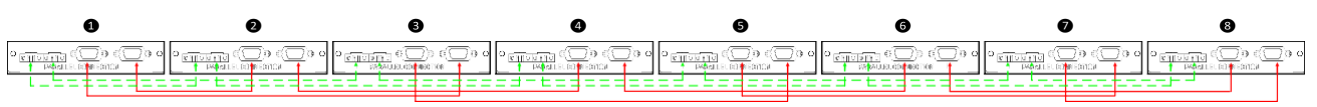

Nine inverters in parallel:

Power Connection

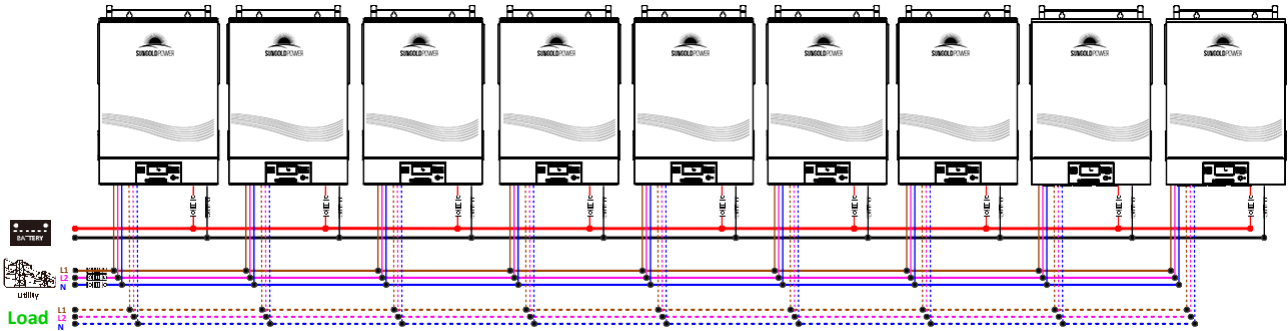

Communication Connection

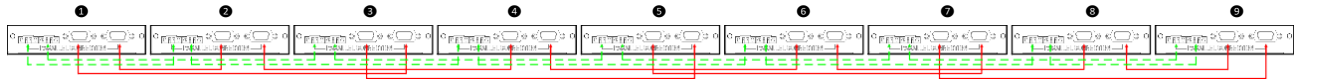

7. PV Connection

Please refer to user manual of single unit for PV Connection.







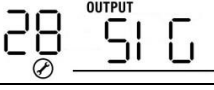
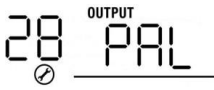

CAUTION: Each inverter should connect to PV modules separately.

7. LCD Setting and Display

Setting Program:

Program	Description	Selectable option	
28	AC output mode *This setting is only available when the inverter is in standby mode (Switch off).	Single: 	When selected, the unit is used in single operation.
		Parallel: 	When selected, this inverter is operated in parallel system. The maximum parallel unit is 9.

Fault code display:

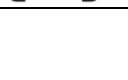
Fault Code	Fault Event	Icon on
60	Power feedback protection	
71	Firmware version inconsistent	
72	Current sharing fault	
80	CAN fault	
81	Host loss	
82	Synchronization loss	
83	Battery voltage detected different	
84	AC input voltage and frequency detected different	
85	AC output current unbalance	

9. Commissioning

Step 1: Check the following requirements before commissioning:

- Correct wire connection
- Ensure all breakers in Line wires of load side are open and each Neutral wires of each unit are connected together.

Step 2: Turn on each unit and set "PAL" in LCD setting program 28 of each unit. And then shut down all units.

NOET: It's necessary to turn off switch when setting LCD program. Otherwise, the setting can not be programmed.

Step 3: Turn on each unit.

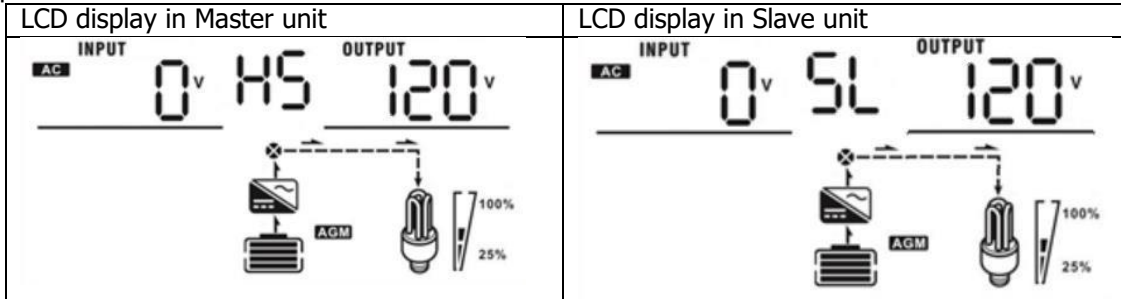

NOTE: Master and slave units are randomly defined. Step 4: Switch on all AC breakers of Line wires in AC input. It's better to have all inverters connect to utility at the same time. If not, it will display fault 82 in following-order inverters. However, these inverters will automatically restart. If detecting AC connection, they will work normally.

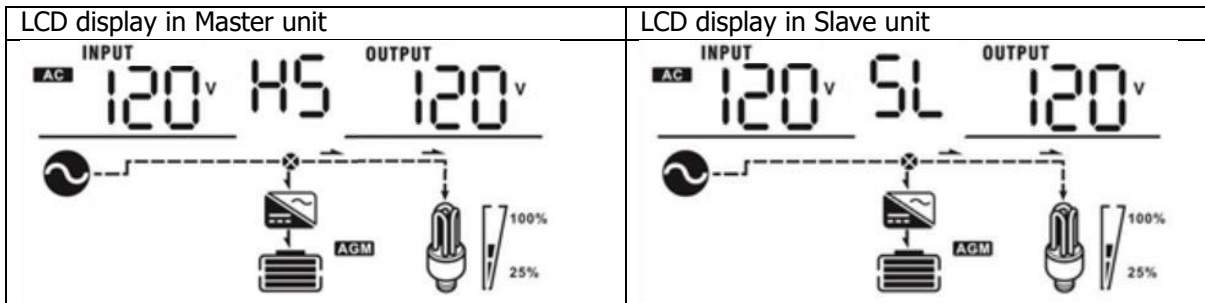

Step 5: If there is no more fault alarm, the parallel system is completely installed.

Step 6: Please switch on all breakers of Line wires in load side. This system will start to provide power to the load.

10. Trouble shooting

Situation		Solution
Fault Code	Fault Event Description	
60	Current feedback into the inverter is detected.	<ol style="list-style-type: none"> 1. Restart the inverter. 2. Check if L/N cables are not connected reversely in all inverters. 3. For parallel system in split phase, make sure the sharing cables are connected well to all inverters. 4. If the problem remains, please contact your installer.
71	The firmware version of each inverter is not the same.	<ol style="list-style-type: none"> 1. Update all inverter firmware to the same version. 2. Check the version of each inverter via LCD setting and make sure the CPU versions are same. If not, please contact your installer to provide the firmware to update. 3. After updating, if the problem still remains, please contact your installer.
72	The output current of each inverter is different.	<ol style="list-style-type: none"> 1. Check if sharing cables are connected well and restart the inverter. 2. If the problem remains, please contact your installer.
80	CAN data loss	<ol style="list-style-type: none"> 1. Check if communication cables are connected well and restart the inverter. 2. If the problem remains, please contact your installer.
81	Host data loss	
82	Synchronization data loss	
83	The battery voltage of each inverter is not the same.	<ol style="list-style-type: none"> 1. Make sure all inverters share same groups of batteries together. 2. Remove all loads and disconnect AC input and PV input. Then, check battery voltage of all inverters. If the values from all inverters are close, please check if all battery cables are the same length and same material

		<p>type. Otherwise, please contact your installer to provide SOP to calibrate battery voltage of each inverter.</p> <p>3. If the problem still remains, please contact your installer.</p>
84	AC input voltage and frequency are detected different.	<p>1. Check the utility wiring connection and restart the inverter.</p> <p>2. Make sure utility starts up at same time. If there are breakers installed between utility and inverters, please be sure all breakers can be turned on AC input at same time.</p> <p>3. If the problem remains, please contact your installer.</p>
85	AC output current unbalance	<p>1. Restart the inverter.</p> <p>2. Remove some excessive loads and re-check load information from LCD of inverters. If the values are different, please check if AC input and output cables are in the same length and material type.</p> <p>3. If the problem remains, please contact your installer.</p>

Appendix II: BMS Communication Installation

1. Introduction

If connecting to lithium battery, it is recommended to purchase a custom-made RJ45 communication cable. Please check with your dealer or integrator for details.

This custom-made RJ45 communication cable delivers information and signal between lithium battery and the inverter. These information are listed below:

- Re-configure charging voltage, charging current and battery discharge cut-off voltage according to the lithium battery parameters.
- Have the inverter start or stop charging according to the status of lithium battery.

2. Pin Assignment for BMS Communication Port

PIN	Definition
PIN 1	RS232TX
PIN 2	RS232RX
PIN 3	RS485B
PIN 4	NC
PIN 5	RS485A
PIN 6	CANH
PIN 7	CANL
PIN 8	GND

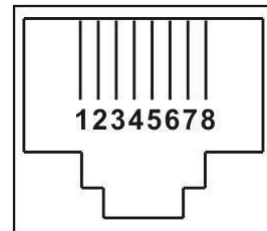

3. Lithium Battery Communication Configuration

LIO-4805/LIO-4810-150A

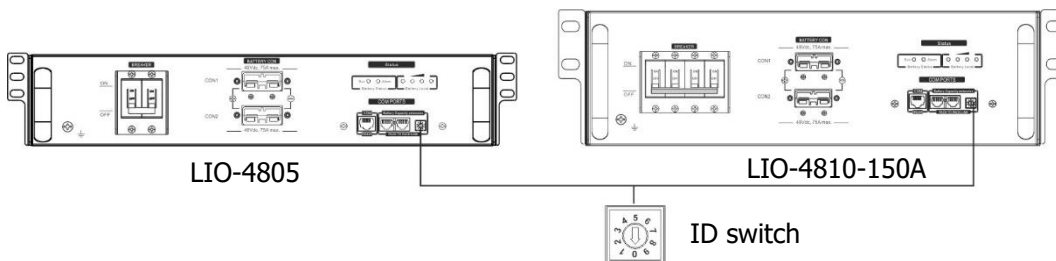

ESS LIO-I 4810

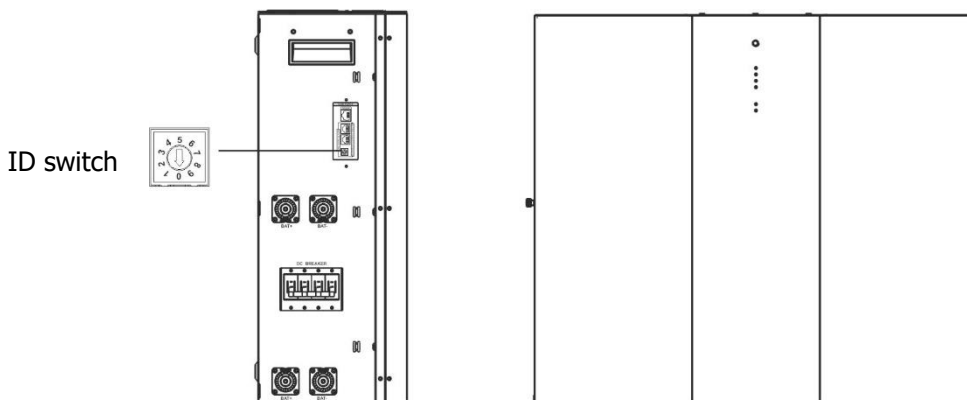

ID Switch indicates the unique ID code for each battery module. It's required to assign a unique ID to each battery module for normal operation. We can set up the ID code for each battery module by rotating the PIN number on the ID switch. From number 0 to 9, the number can be random; no particular order. Maximum 10 battery modules can be operated in parallel.

PYLONTECH

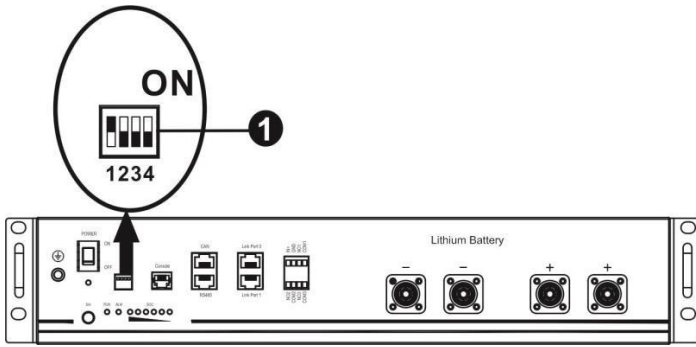

Dip Switch: There are 4 Dip Switches that sets different baud rate and battery group address. If switch position is turned to the "OFF" position, it means "0". If switch position is turned to the "ON" position, it means "1".

Dip 1 is "ON" to represent the baud rate 9600.

Dip 2, 3 and 4 are to set up battery group address.

Dip switch 2, 3 and 4 on master battery (first battery) are to set up or change the group address.

NOTE: "1" is upper position and "0" is bottom position.

Dip 1	Dip 2	Dip 3	Dip 4	Group address
1: RS485 baud rate=9600 Restart to take effect	0	0	0	Single group only. It's necessary to set up master battery with this setting and slave batteries are unrestricted.
	1	0	0	Multiple group condition. It's necessary to set up master battery on the first group with this setting and slave batteries are unrestricted.
	0	1	0	Multiple group condition. It's necessary to set up master battery on the second group with this setting and slave batteries are unrestricted.
	1	1	0	Multiple group condition. It's necessary to set up master battery on the third group with this setting and slave batteries are unrestricted.
	0	0	1	Multiple group condition. It's necessary to set up master battery on the forth group with this setting and slave batteries are unrestricted.
	1	0	1	Multiple group condition. It's necessary to set up master battery on the fifth group with this setting and slave batteries are unrestricted.

NOTE: The maximum groups of lithium battery is 5 and for maximum number for each group, please check with battery manufacturer.

4. Installation and Operation

LIO-4805/LIO-4810-150A/ESS LIO-I 4810

After ID no. is assigned for each battery module, please set up LCD panel in inverter and install the wiring connection as following steps.

Step 1: Use supplied RJ11 signal cable to connect into the extension port (P1 or P2).

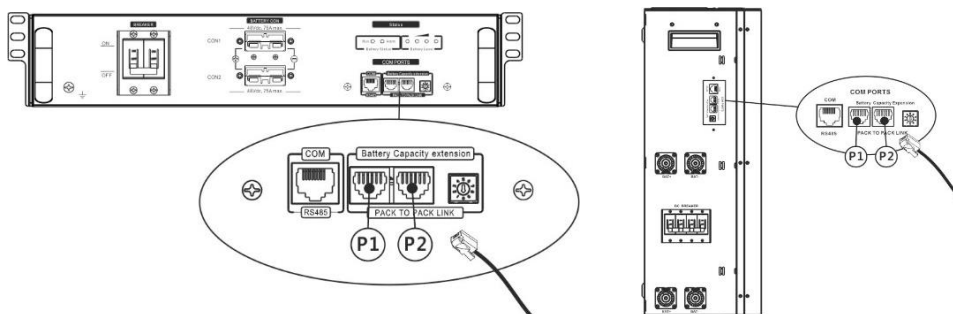

Step 2: Use supplied RJ45 cable (from battery module package) to connect inverter and Lithium battery.

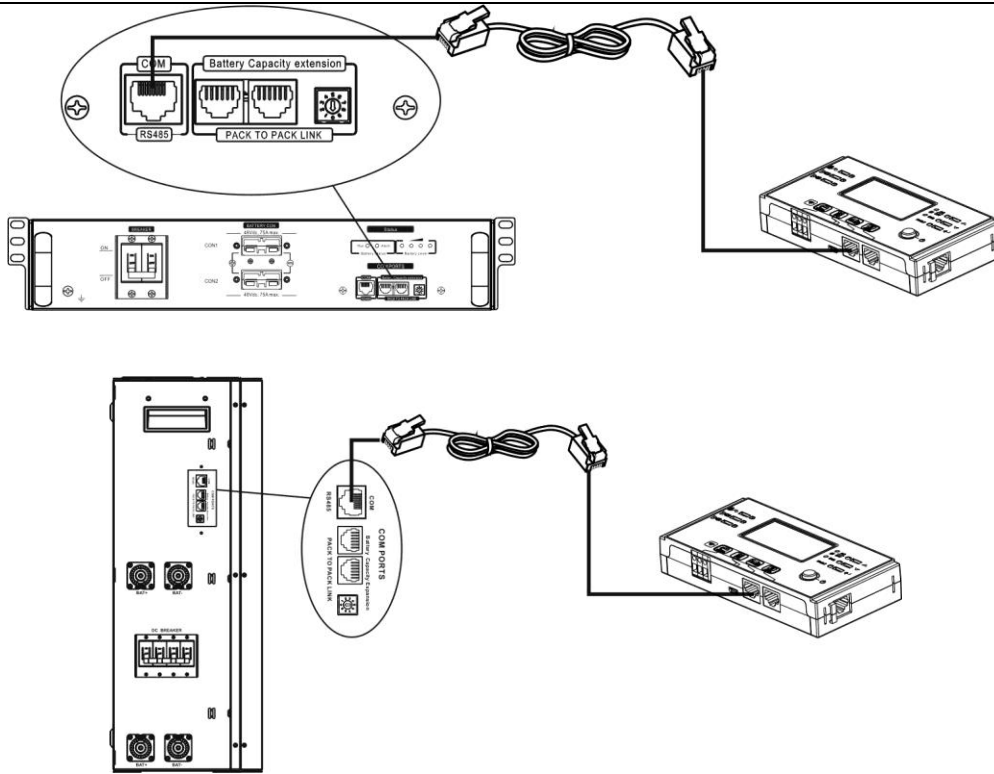

*** For multiple battery connection, please check battery manual for the details.**

Note for parallel system:

1. Only support common battery installation.
2. Use custom-made RJ45 cable to connect any inverter (no need to connect to a specific inverter) and Lithium battery. Simply set this inverter battery type to "LIb" in LCD program 14. Others should be "USE".

Step 3: Turn the breaker switch "ON". Now, the battery module is ready for DC output.

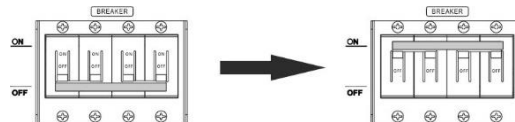

Step 4: Press Power on/off button on battery module for 5 secs, the battery module will start up.

*If the manual button cannot be approached, just simply turn on the inverter module. The battery module will be automatically turned on.

Step 5. Turn on the inverter.

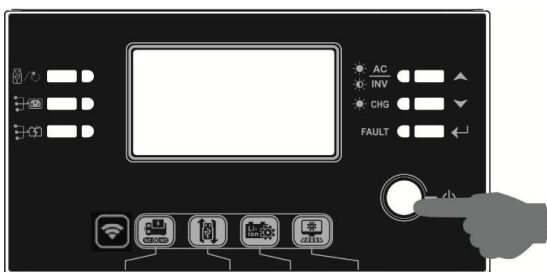

Step 6. Be sure to select battery type as "LIb" in LCD program 14.



PYLONTECH

After configuration, please install LCD panel with inverter and Lithium battery with the following steps.

Step 1. Use custom-made RJ45 cable to connect inverter and Lithium battery.

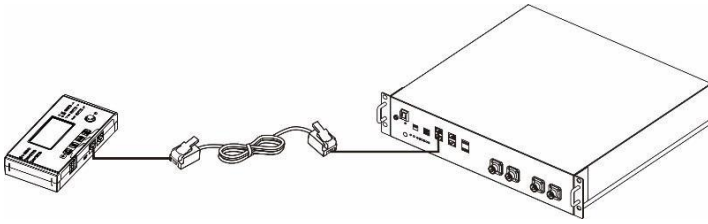

Note for parallel system:

- 3. Only support common battery installation.
- 4. Use custom-made RJ45 cable to connect any inverter (no need to connect to a specific inverter) and Lithium battery. Simply set this inverter battery type to "PYL" in LCD program 5. Others should be "USE".

Step 2. Switch on Lithium battery.

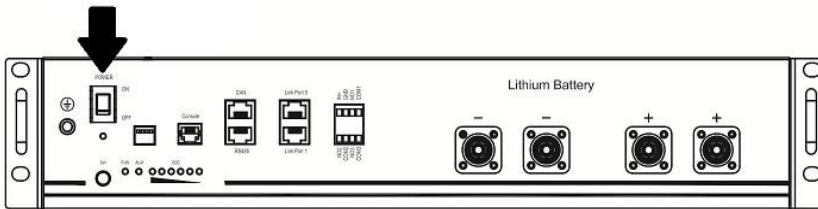

Step 3. Press more than three seconds to start Lithium battery, power output ready.

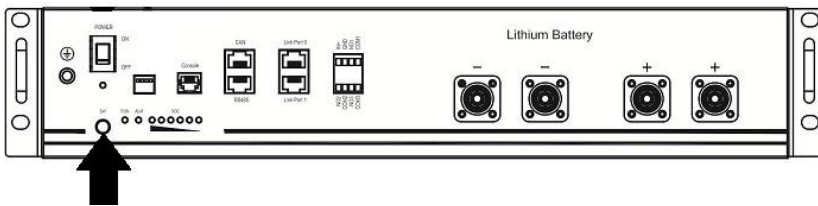

Step 4. Turn on the inverter.

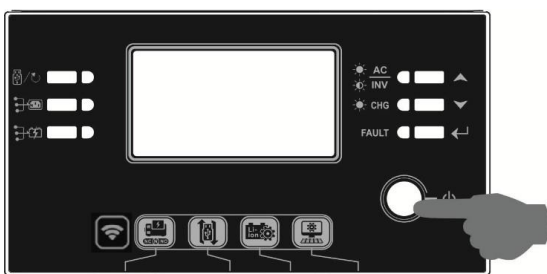

Step 5. Be sure to select battery type as "PYL" in LCD program 14.

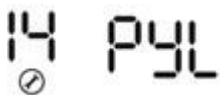

WECO

Step 1. Use custom-made RJ45 cable to connect inverter and Lithium battery.

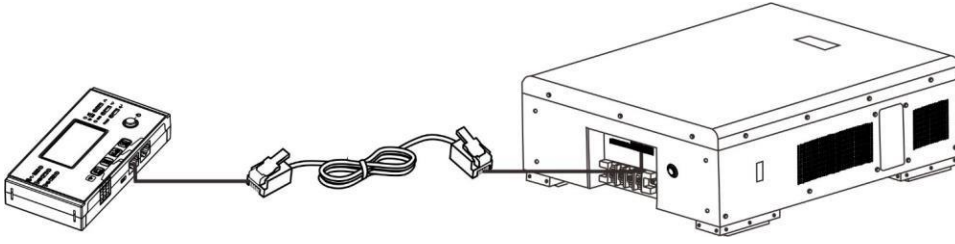

Note for parallel system:

1. Only support common battery installation.
2. Use custom-made RJ45 cable to connect any inverter (no need to connect to a specific inverter) and Lithium battery. Simply set this inverter battery type to "WEC" in LCD program 5. Others should be "USE".

Step 2. Switch on Lithium battery.

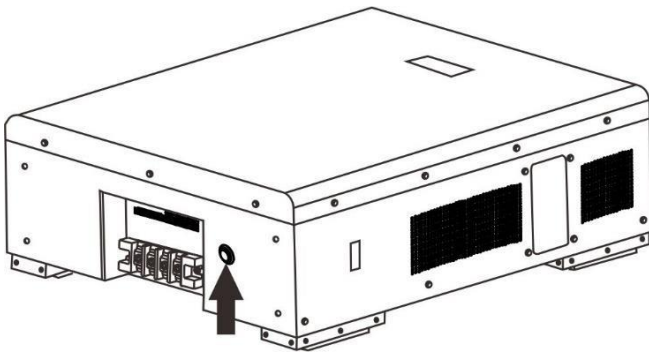

Step 3. Turn on the inverter.

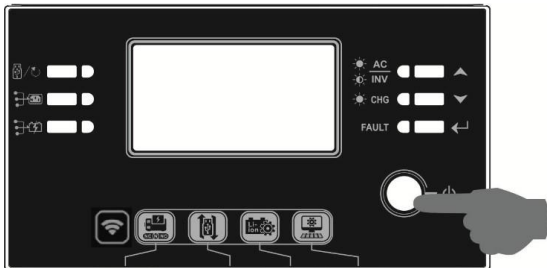

Step 4. Be sure to select battery type as "WEC" in LCD program 14.

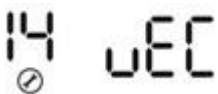

SOLTARO

Step 1. Use custom-made RJ45 cable to connect inverter and Lithium battery.

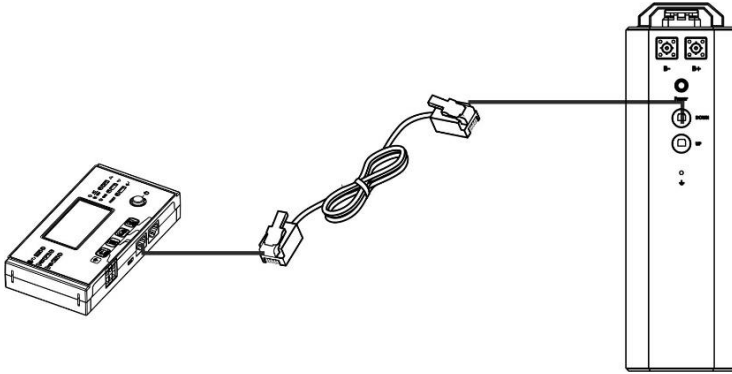

Note for parallel system:

1. Only support common battery installation.
2. Use custom-made RJ45 cable to connect any inverter (no need to connect to a specific inverter) and Lithium battery. Simply set this inverter battery type to "SOL" in LCD program 5. Others should be "USE".

Step 2. Open DC isolator and switch on Lithium battery.

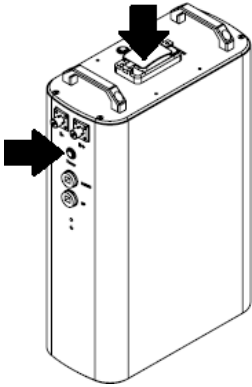

Step 3. Turn on the inverter.

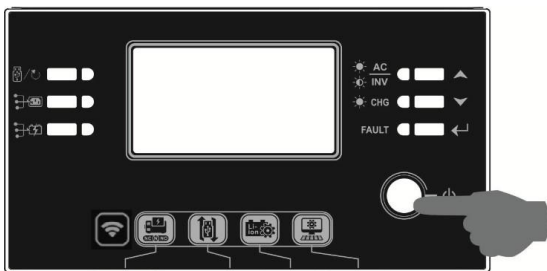

Step 4. Be sure to select battery type as "SOL" in LCD program 14.

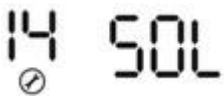

5. LCD Display Information

Press "UP" or "DOWN" key to switch LCD display information. It will show battery pack and battery group number before "Main CPU version checking" as below screen.

Selectable information	LCD display
Battery pack numbers & Battery group numbers	<p>Battery pack numbers = 3, battery group numbers = 1</p>

6. Code Reference

Related information code will be displayed on LCD screen. Please check inverter LCD screen for the operation.

Code	Description
	If battery status is not allowed to charge and discharge after the communication between the inverter and battery is successful, it will show code 60 to stop charging and discharging battery.
	Communication lost (only available when the battery type is setting as "Pylontech Battery" or "WECO Battery" or "Soltaro Battery") <ul style="list-style-type: none"> ● After battery is connected, communication signal is not detected for 3 minutes, buzzer will beep. After 10 minutes, inverter will stop charging and discharging to lithium battery. ● Communication lost occurs after the inverter and battery is connected successfully, buzzer beeps immediately.
	If battery status is not allowed to charge after the communication between the inverter and battery is successful, it will show code 69 to stop charging battery.
	If battery status must to charge after the communication between the inverter and battery is successful, it will show code 70 to charge battery.
	If battery status is not allowed to discharge after the communication between the inverter and battery is successful, it will show code 71 to stop discharge battery.

Appendix III: Approximate Back-up Time Table

Model	Load (VA)	Backup Time @ 48Vdc 200Ah (min)	Backup Time @ 48Vdc 400Ah (min)
BluePower TP6048	500	1226	2576
	1000	536	1226
	1500	316	804
	2000	222	542
	2500	180	430
	3000	152	364
	3500	130	282
	4000	100	224
	4500	88	200
	5000	80	180
	5500	70	160
	6000	60	140

Note: Backup time depends on the quality of the battery, age of battery and type of battery.
Specifications of batteries may vary depending on different manufacturers.

Appendix IV: The Wi-Fi Operation Guide in Remote Panel

1. Introduction

Wi-Fi module can enable wireless communication between off-grid inverters and monitoring platform. Users have complete and remote monitoring and controlling experience for inverters when combining Wi-Fi module with SolarPower APP, available for both iOS and Android based device. All data loggers and parameters are saved in iCloud.

The major functions of this APP:

- Delivers device status during normal operation.
- Allows to configure device setting after installation.
- Notifies users when a warning or alarm occurs.
- Allows users to query inverter history data.

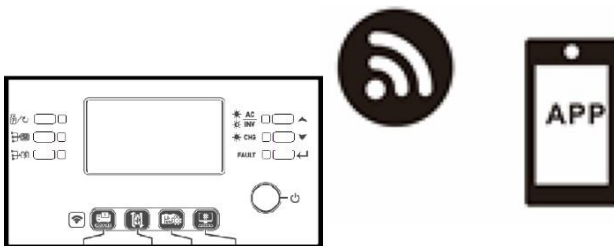

2. SolarPower App

2.1. Download and install APP

Operating system requirement for your smart phone:

🍏 iOS system supports iOS 9.0 and above

🤖 Android system supports Android 5.0 and above

Please scan the following QR code with your smart phone and download SolarPower App.



Android
system





iOS system

Or you may find "SolarPower" app from the Apple® Store or "SolarPower Wi-Fi" in Google® Play Store.



Initial Setup

Step 1: Registration at first time

After the installation, please tap the shortcut icon  to access this APP on your mobile screen. In the screen, tap "Register" to access "User Registration" page. Fill in all required information and scan the remote box PN by tapping  icon. Or you can simply enter PN directly. Then, tap "Register" button.

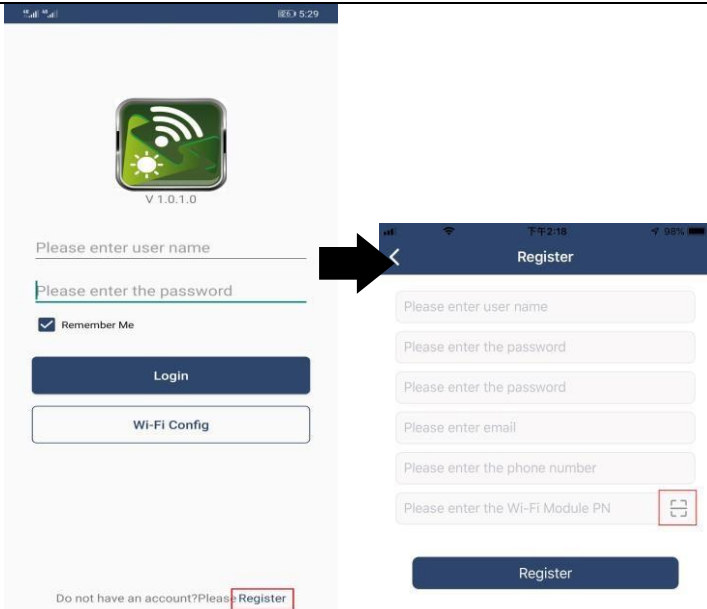

Then, a "Registration success" window will pop up. Tap "Go now" to continue setting local Wi-Fi network connection.

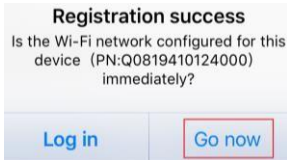

Step 2: Local Wi-Fi Module Configuration

Now, you are in "Wi-Fi Config" page. There are detailed setup procedure listed in "How to connect?" section and you may follow it to connect Wi-Fi.

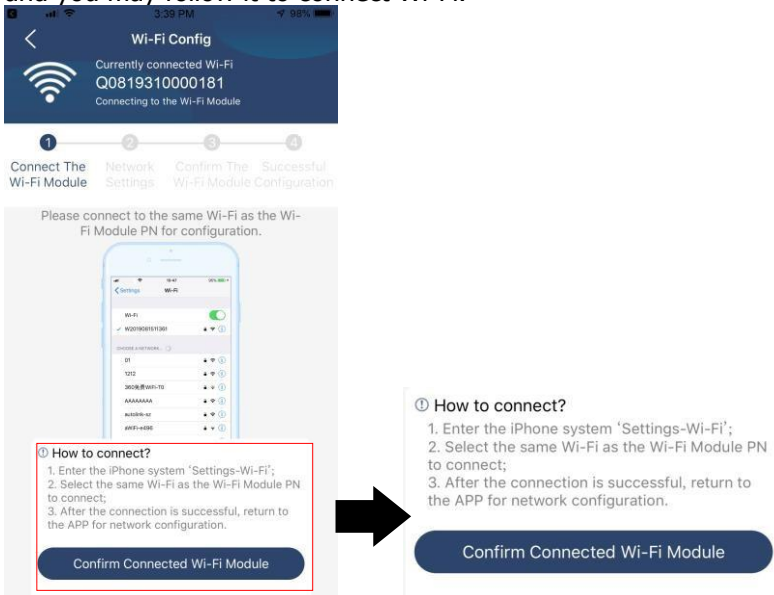

Enter the "Settings→Wi-Fi" and select connected Wi-Fi. The connected Wi-Fi name is the same to your Wi-Fi PN number and enter default password "12345678".

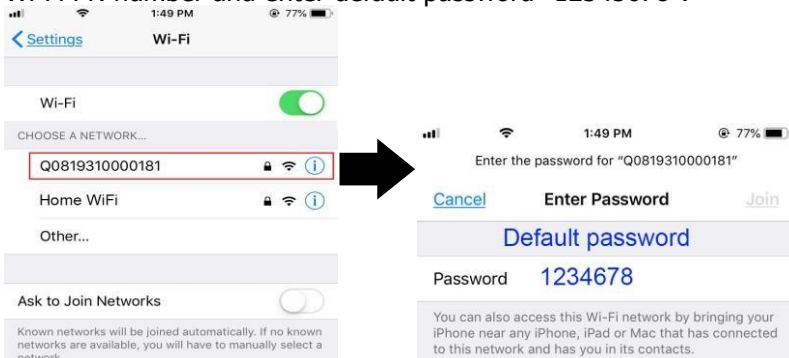

Then, return to SolarPower APP and tap "Confirm Connected Wi-Fi Module" button when Wi-Fi module is connected successfully.

Step 3: Wi-Fi Network settings

Tap  icon to select your local Wi-Fi router name (to access the internet) and enter password.

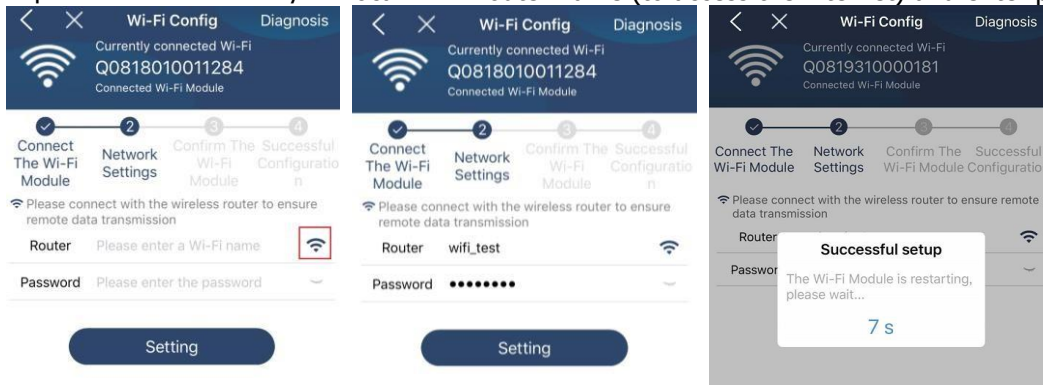

Step 4: Tap "Confirm" to complete the Wi-Fi configuration between the Wi-Fi module and the Internet.

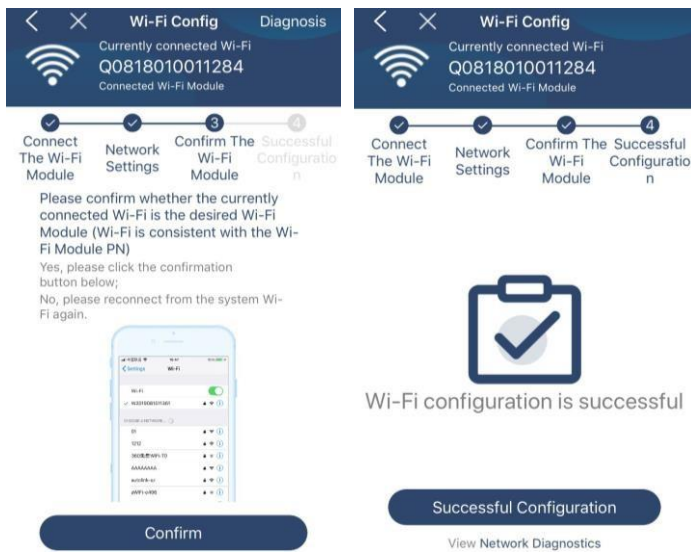

If the connection fails, please repeat Step 2 and 3.

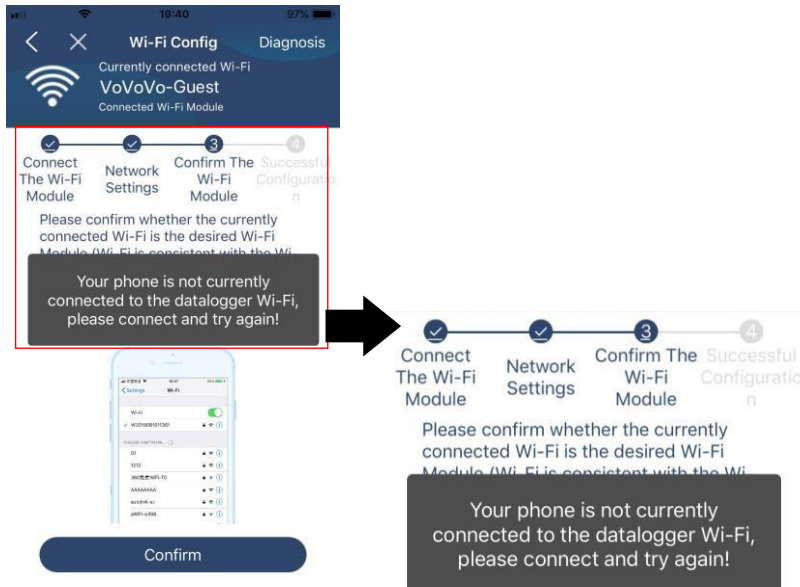

Diagnose Function

If the module is not monitoring properly, please tap "Diagnosis" on the top right corner of the screen for further details. It will show repair suggestion. Please follow it to fix the problem. Then, repeat the steps in the chapter 4.2 to re-set network setting. After all setting, tap "Rediagnosis" to re-connect again.

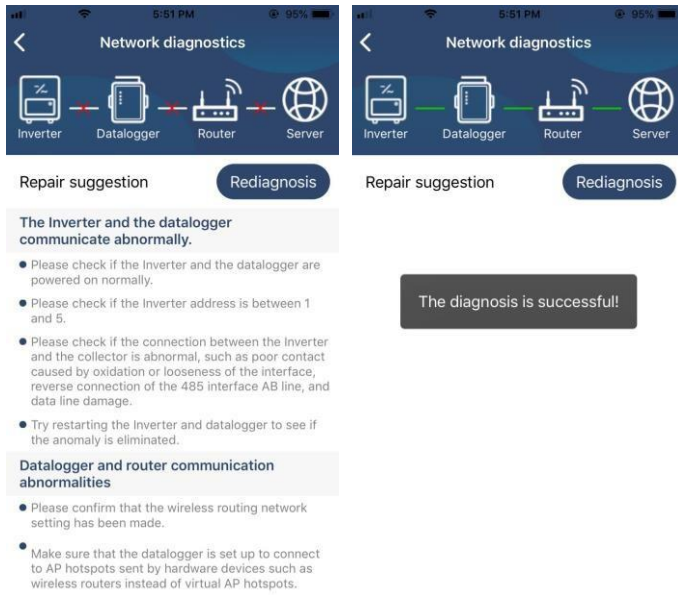

Login and APP Main Function

After finishing the registration and local Wi-Fi configuration, enter registered name and password to login. Note: Tick "Remember Me" for your login convenience afterwards.

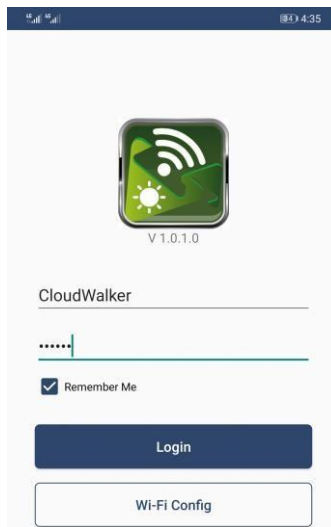

Overview

After login is successfully, you can access "Overview" page to have overview of your monitoring devices, including overall operation situation and Energy information for Current power and Today power as below diagram.



Devices

Tap the  icon (located on the bottom) to enter Device List page. You can review all devices here by adding or deleting Wi-Fi Module in this page.

Add device



Delete device

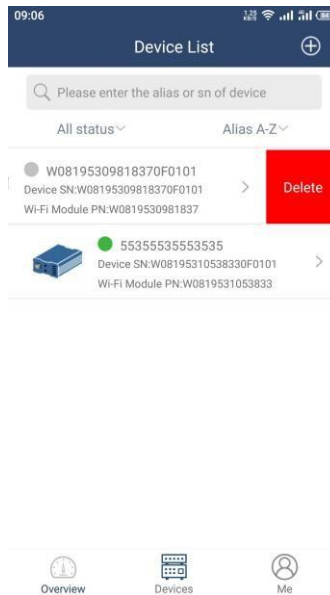

Tap  icon on the top right corner and manually enter part number to add device. This part number label is pasted on the bottom of remote LCD panel. After entering part number, tap "Confirm" to add this device in the Device list.

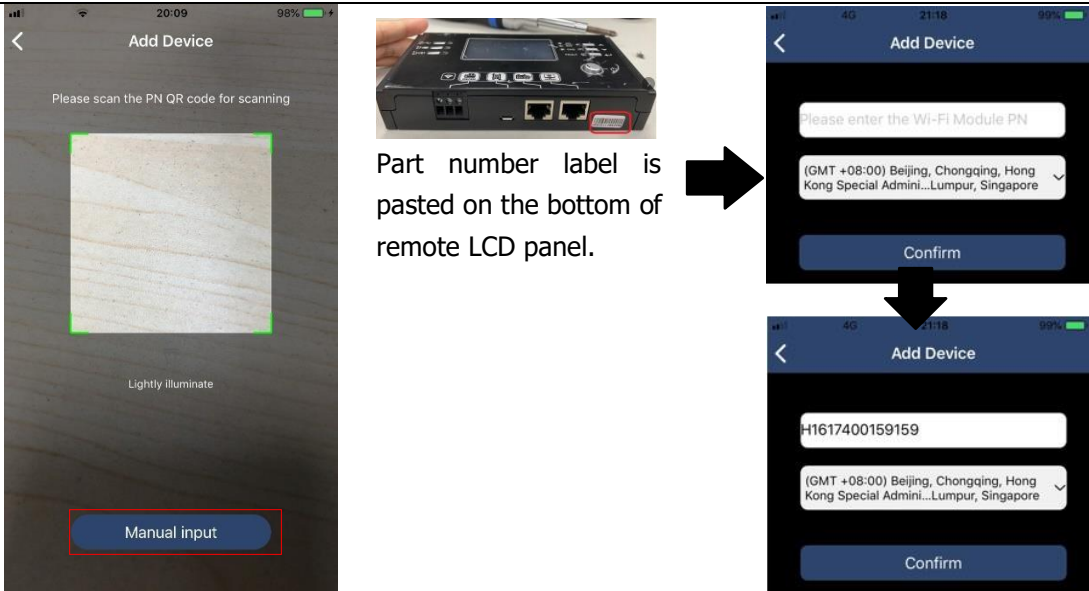

Part number label is pasted on the bottom of remote LCD panel.

For more information about Device List, please refer to the section 2.4.

ME

In ME page, users can modify “My information”, including 【User’s Photo】 , 【Account security】 , 【Modify password】 , 【Clear cache】 ,and 【Log-out】 , shown as below diagrams.

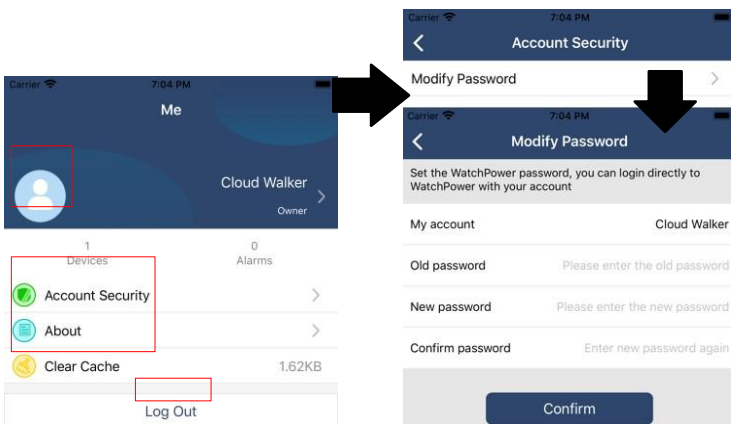

2.2. Device List

In Device List page, you can pull down to refresh the device information and then tap any device you want to check up for its real-time status and related information as well as to change parameter settings. Please refer to the parameter setting list.

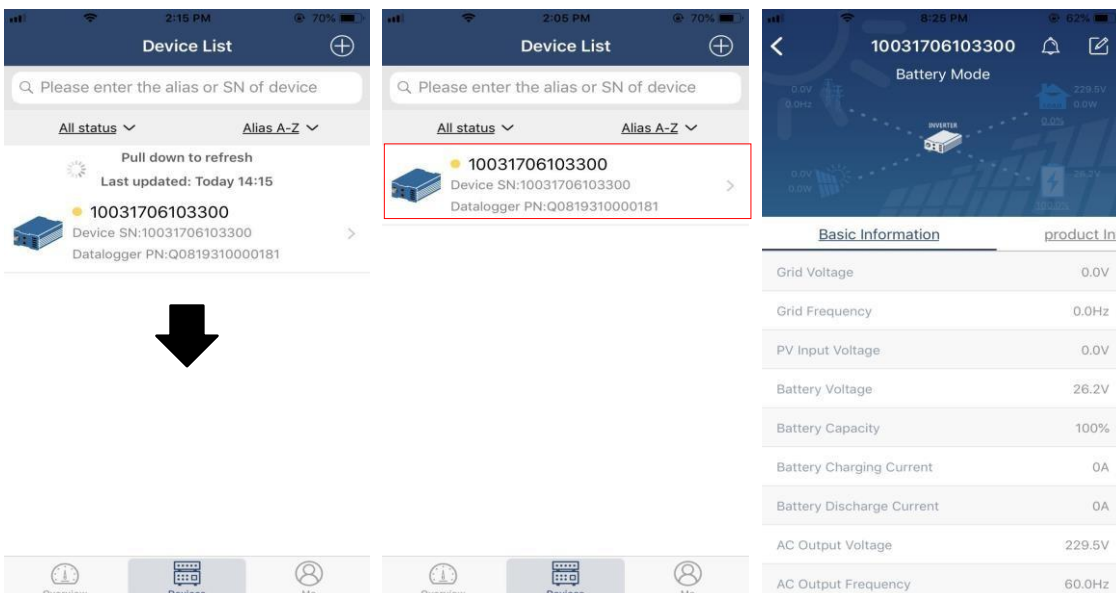

Device Mode

On the top of screen, there is a dynamic power flow chart to show live operation. It contains five icons to present PV power, inverter, load, utility and battery. Based on your inverter model status, there will be **【Standby Mode】** , **【Line Mode】** , **【Battery Mode】** .

【Standby Mode】 Inverter will not power the load until “ON” switch is pressed. Qualified utility or PV source can charge battery in standby mode.





【Line Mode】 Inverter will power the load from the utility with or without PV charging. Qualified utility or PV source can charge battery.



【Battery Mode】 Inverter will power the load from the batter with or without PV charging. Only PV source can charge battery.



Device Alarm and Name Modification

In this page, tap the  icon on the top right corner to enter the device alarm page. Then, you can review alarm history and detailed information. Tap the  icon on the top right corner, a blank input box will pop out. Then, you can edit the name for your device and tap “Confirm” to complete name modification.

Basic information	Product information	Rated info
Grid Voltage		0.0V
Grid Frequency		0.0Hz
PV Input Voltage		302.7V
Battery Voltage		28.3V
Battery Capacity		100%
Battery Charging Current		0A
Battery Discharge Current		0A
AC Output Voltage		230.2V

Device Information Data

Users can check up **【Basic Information】** , **【Product Information】** , **【Rated information】** , **【History】** , and **【Wi-Fi Module Information】** by swiping left.



← Swipe left

Basic Information	product info
Grid Voltage	0.0V
Grid Frequency	0.0Hz
PV Input Voltage	0.0V
Battery Voltage	26.2V
Battery Capacity	100%
Battery Charging Current	0A
Battery Discharge Current	0A
AC Output Voltage	229.5V
AC Output Frequency	60.0Hz

【Basic Information】 displays basic information of the inverter, including AC voltage, AC frequency, PV input voltage, Battery voltage, Battery capacity, Charging current, Output voltage, Output frequency, Output apparent power, Output active power and Load percent. Please slide up to see more basic information.

【Production Information】 displays Model type (Inverter type), Main CPU version and secondary CPU version.

【Rated Information】 displays information of Nominal AC voltage, Nominal AC current, Rated battery voltage, Nominal output voltage, Nominal output frequency, Nominal output current, Nominal output apparent power and Nominal output active power. Please slide up to see more rated information.

【History】 displays the record of unit information and setting timely.

【Wi-Fi Module Information】 displays of Wi-Fi Module PN, status and firmware version.

Parameter Setting

This page is to activate some features and set up parameters for inverters. Please be noted that the listing in "Parameter Setting" page in below diagram may differ from the models of monitored inverter. Here will briefly highlight some of it, **【Output Setting】**, **【Battery Parameter Setting】**, **【Enable/ Disable items】**, **【Restore to the defaults】** to illustrate.



Parameter Setting	Wi-Fi Mod
Output Setting	>
Battery Parameter Setting	>
Enable/Disable items	>
Restore to the defaults	>
Time zone setting	>
Wi-Fi Module configuration	>

There are three ways to modify setting and they vary according to each parameter.

- a) Listing options to change values by tapping one of it.
- b) Activate/Shut down functions by clicking "Enable" or "Disable" button.
- c) Changing values by clicking arrows or entering the numbers directly in the column.

Each function setting is saved by clicking "Set" button.

Please refer to below parameter setting list for an overall description and be noted that the available parameters may vary depending on different models. Please always see the original product manual for detailed setting instructions.

Parameter setting list:

Item		Description
Output setting	Output source priority	To configure load power source priority.
	AC input range	Input voltage range selection
	Output voltage	To set output voltage.
	Output frequency	To set output frequency.
Battery parameter setting	Battery Type	Select connected battery type
	Battery Cut-off Voltage	Set battery cut-off voltage
	Bulk Charging Voltage	Set battery bulk charging voltage
	Battery Float Voltage	Set battery floating charging voltage
	Max Charging Current	To configure total charging current for solar and utility chargers.
	Max AC Charging Current	Set maximum utility charging current
	Charging Source Priority	To configure charger source priority
	Back To Grid Voltage	Set battery voltage to stop discharging when grid is available
	Back To Discharge Voltage	Set battery voltage to stop charging when grid is available
Enable/Disable Functions	Overload Auto Restart	If disabled, the unit won't be restarted after overload occurs.
	Overload Temperature Auto Restart	If disabled, the unit won't be restarted after over-temperature fault is solved.
	Overload Bypass	If enabled, the unit will enter bypass mode when overload occurs.
	Beeps While Primary Source Interrupt	If enabled, buzzer will alarm when primary source is abnormal.
	Buzzer	If disabled, buzzer won't be on when alarm/fault occurred.
	Backlight	If disabled, LCD backlight will be off when panel button is not operated for 1 minute.
	LCD Screen Return To Default Display	If selected, no matter how users switch display screen, it will automatically return to default display screen (Input voltage /output voltage) after no button is pressed for 1 minute.
	Fault Code	If enabled, fault code will be recorded in the inverter when any fault

	Record	happens.
	Solar Supply Priority	Set solar power as priority to charge the battery or to power the load.
	Reset PV Energy Storage	If clicked, PV energy storage data will be reset.
	Start Time For Enable AC Charge Working	The setting range of start charging time for AC charger is from 00:00 to 23:00. The increment of each click is 1 hour.
	Ending Time For Enable AC Charge Working	The setting range of stop charging time for AC charger is from 00:00 to 23:00. The increment of each click is 1 hour.
	Scheduled Time For AC Output On	The setting range of scheduled time for AC output on is from 00:00 to 23:00. The increment of each click is 1 hour.
	Scheduled Time For AC Output Off	The setting range of scheduled time for AC output off is from 00:00 to 23:00. The increment of each click is 1 hour.
	Country Customized Regulations	Select inverter installed area to meet local regulation.
	Set Date Time	Set date time.
Restore to the default	This function is to restore all settings back to default settings.	