

Dispenser: 21.2905 2 THN-MS/280

heating element 230V-1600W

Crockery:

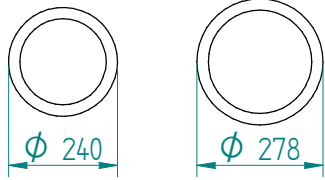

from $\phi 240$ to $\phi 278$

Dimensions: weight (empty): 53 kg

A x B = trolley, excl. corner bumpers

E x F = trolley, incl. corner bumpers

H = trolley height

S = effective stacking height

T = height with push bar

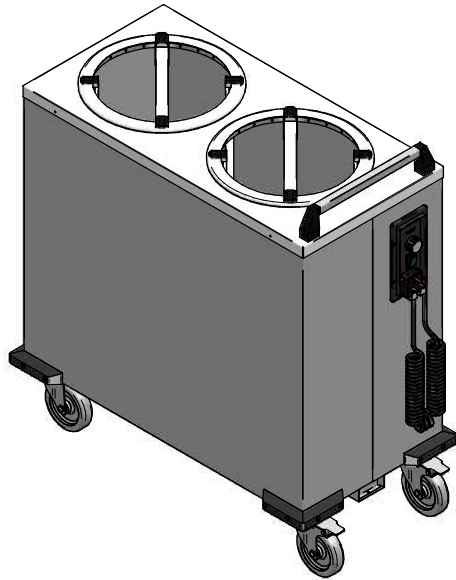

MUKL

VR :

IR :

MOBILE CONTAINING

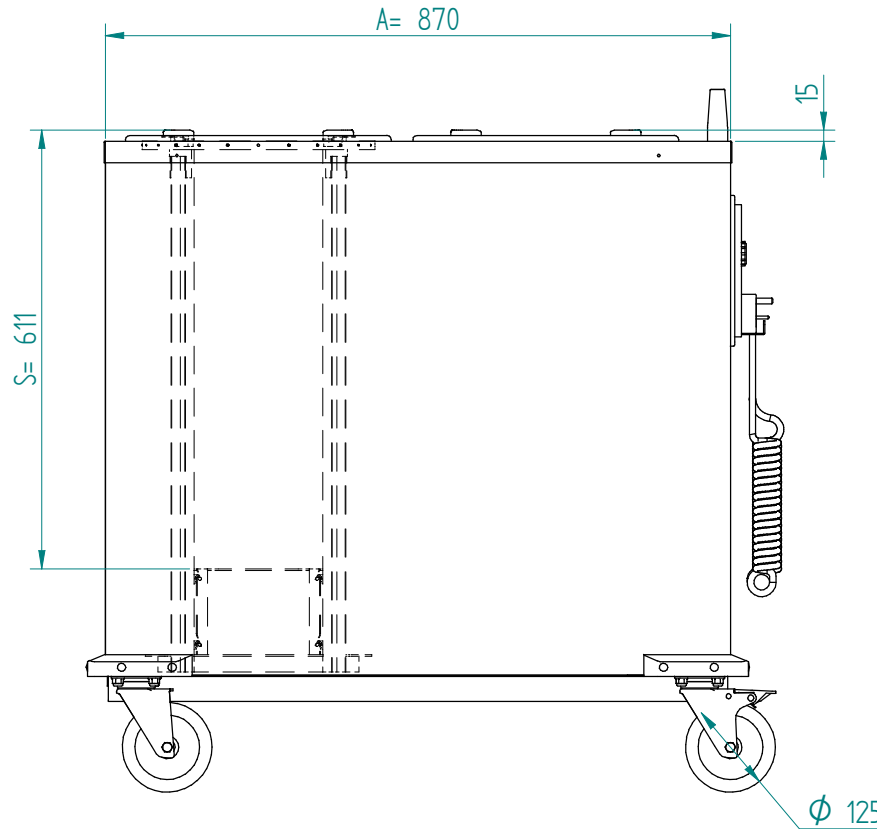
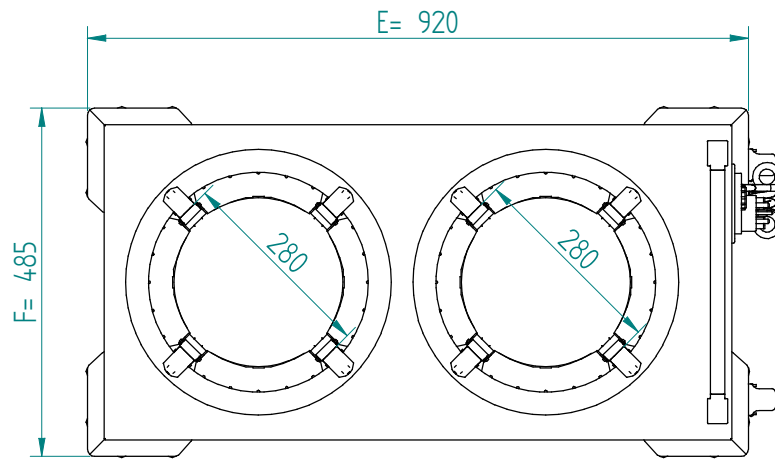

4 swivel castors, 2 with brake

options, order separate;

stst cover: 92.5085

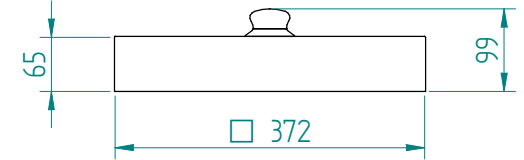

pc cover: 91.5030

