

Dispenser:
11.2320 2 TN-MS/240

Crockery:

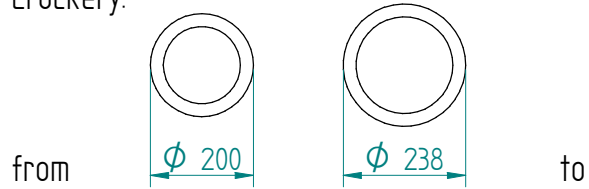

Dimensions: weight (empty): 35 kg
A x B = trolley, excl. corner bumpers
E x F = trolley, incl. corner bumpers
H = trolley height
S = effective stacking height
T = height with push bar

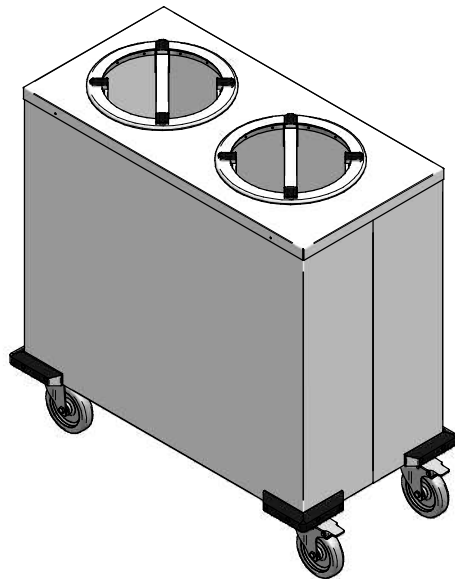

EN

VR :

IR :

MOBILE CONTAINING

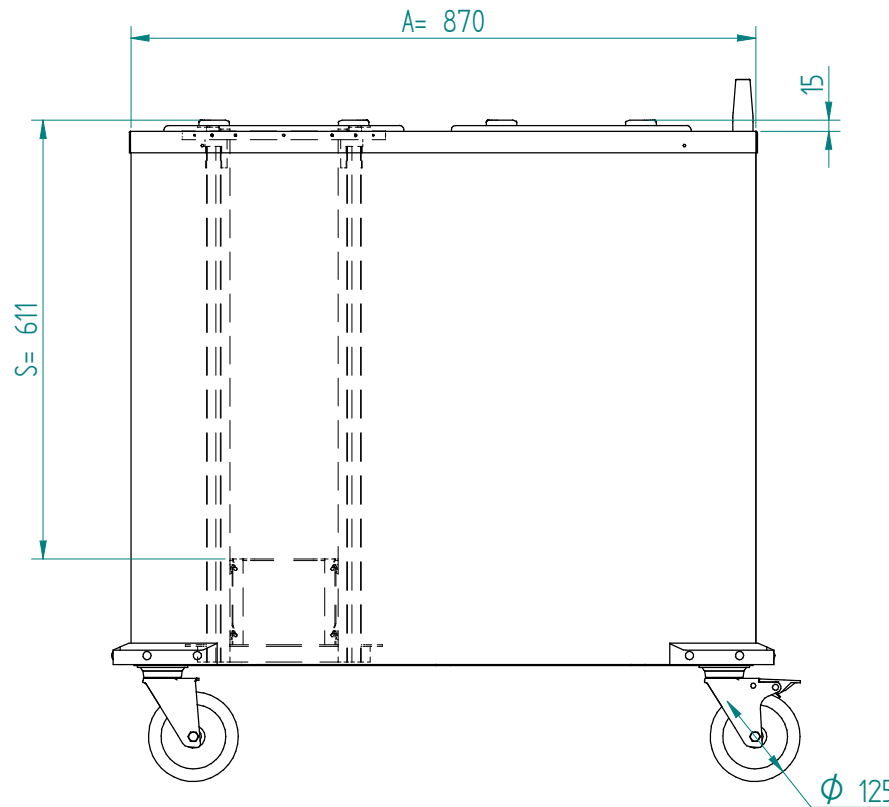
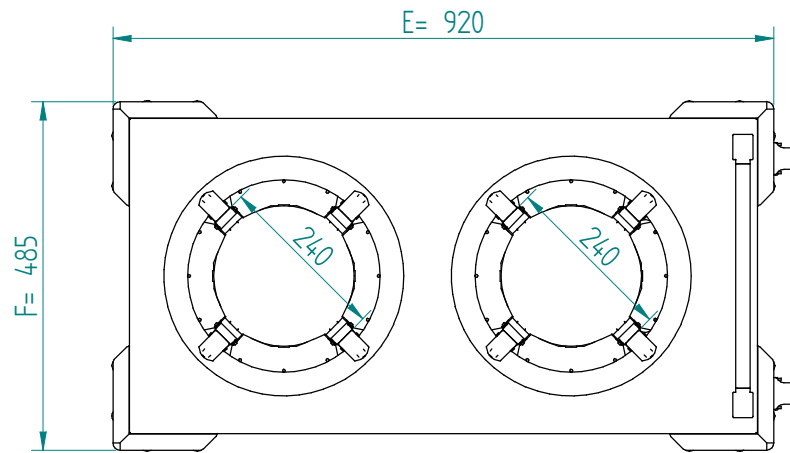

4 swivel castors, 2 with brake

options, order separate;
push bar: 90.5000

stst cover: 92.5075

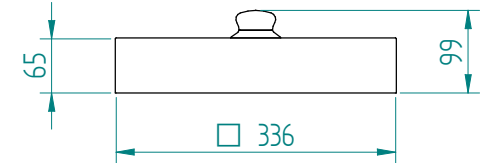

pc cover: 91.5020

