

Dispenser: 03.1746.NC DFE 310 heated heating element 230V-400W

Crockery:

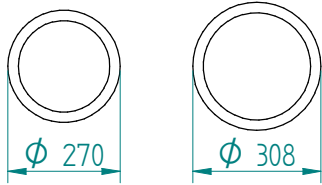

from to

Dimensions: weight (empty): 10 kg
 A = flange
 E = cut out
 H = build in height
 S = effective stacking height
 y x z = cut out operating panel

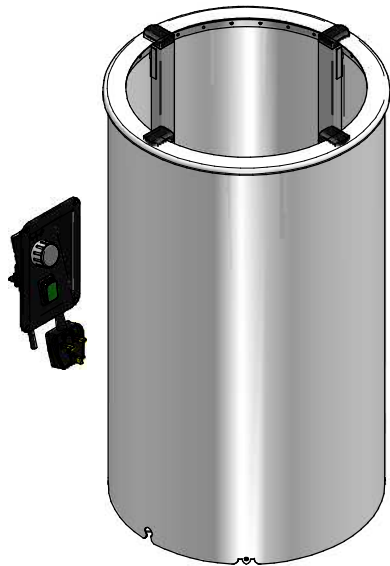

MUKL

VR :

IR :

MOBILE CONTAINING

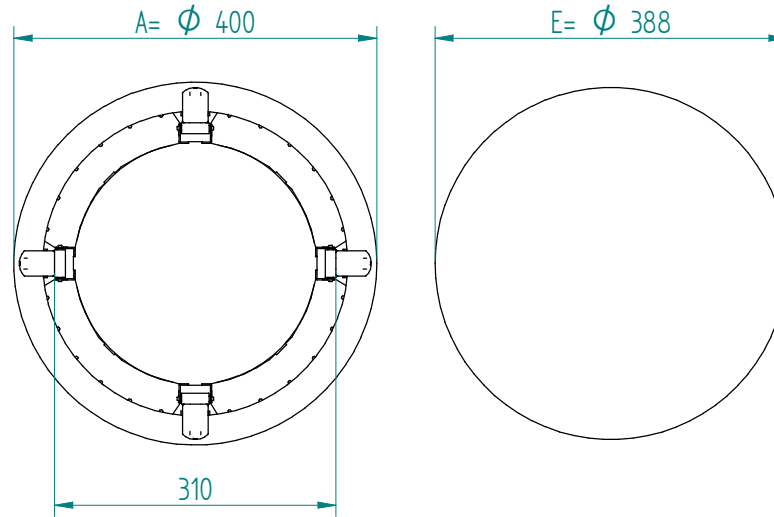

options, order separate;
 pc cover: 91.5040

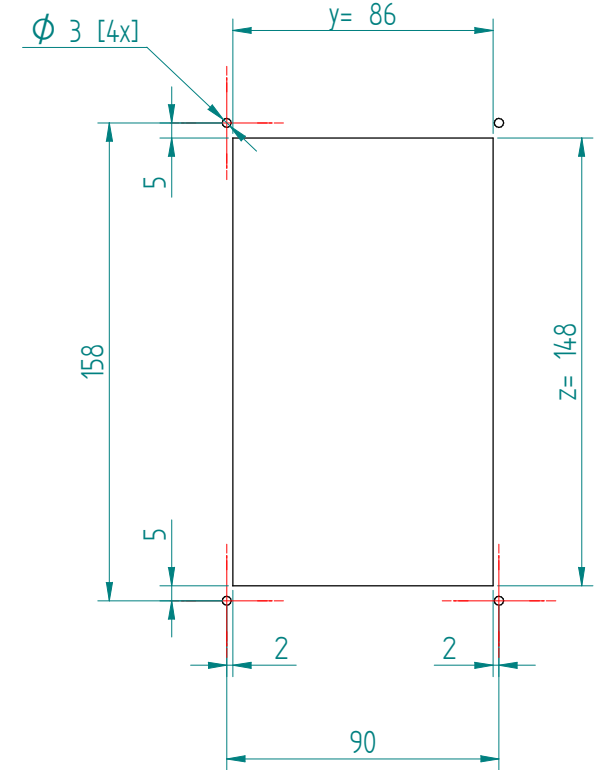
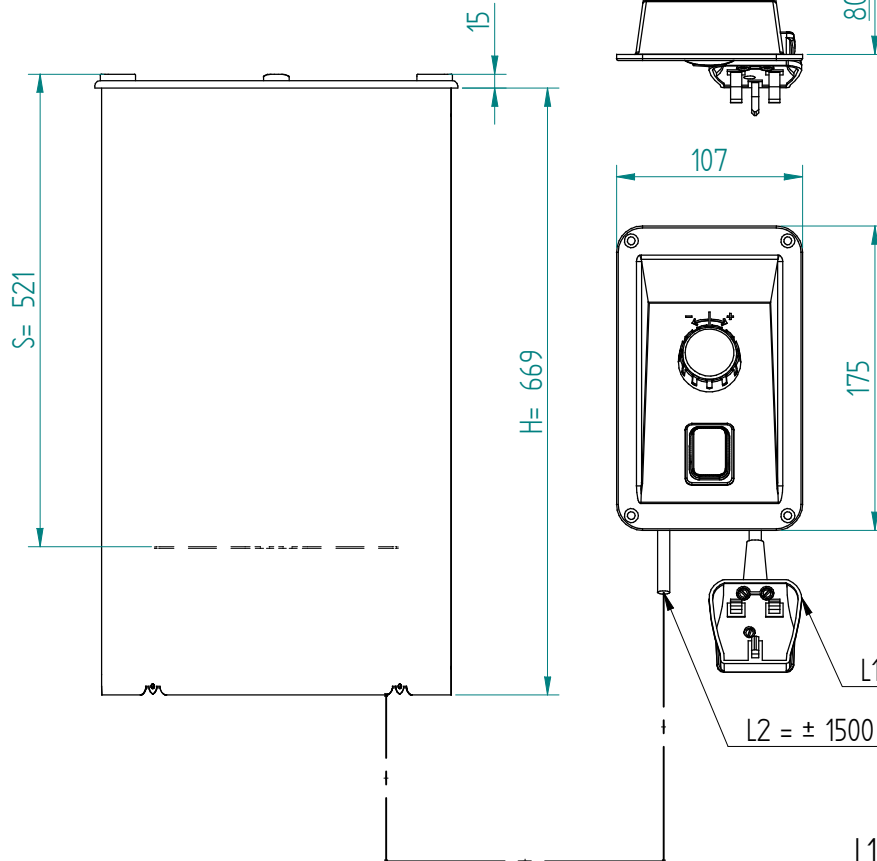
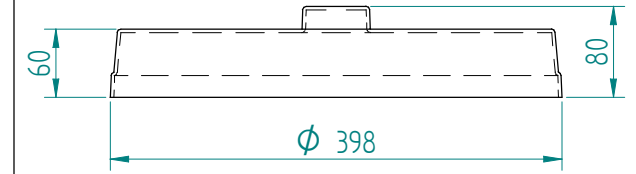

L1 = length cable with plug
 L2 = length cable between tube and operating panel