

Dispenser:
01.1363.NC DFE 340 unheated

Crockery:
from  ϕ 300 to  ϕ 338

Dimensions:
A = flange
E = cut out
H = build in height
S = effective stacking height
weight (empty): 6 kg

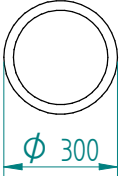
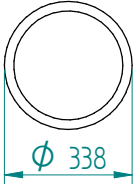
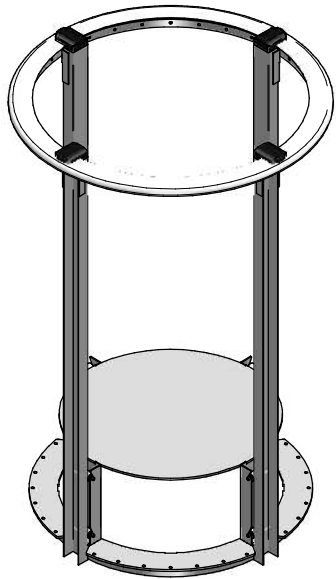

MUKL

VR :

IR :

MOBILE CONTAINING

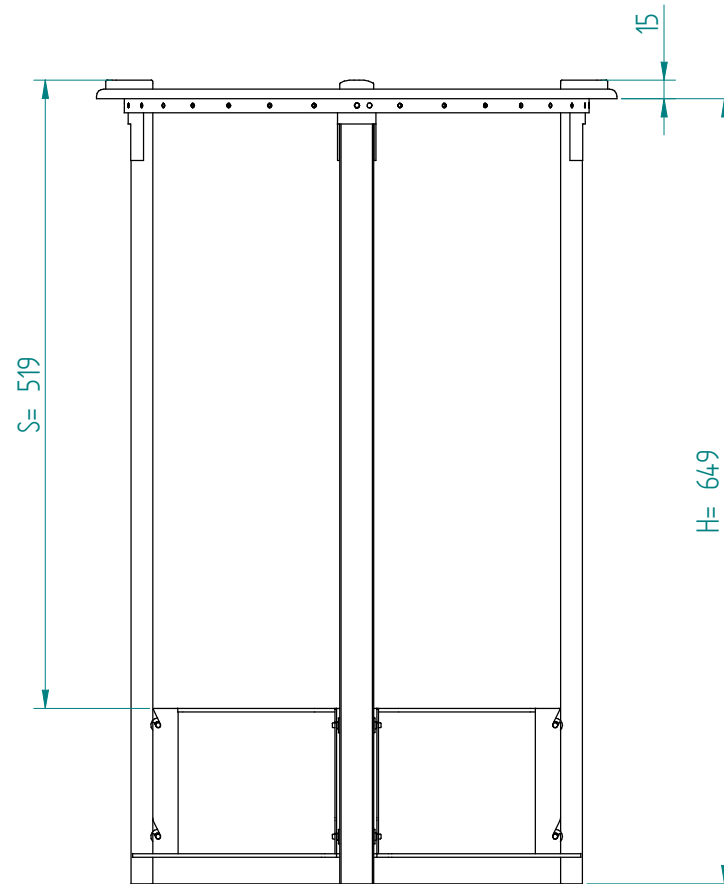
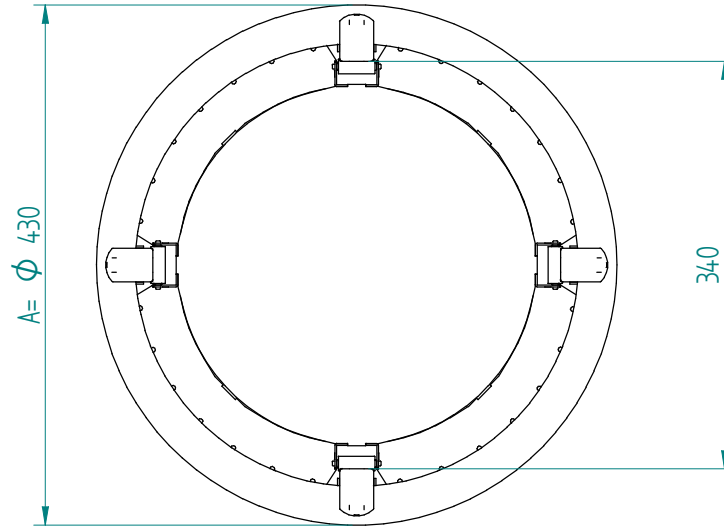

options, order separate;
pc cover: 91.5043

