

Parts Breakdown

94-6775
323-0500

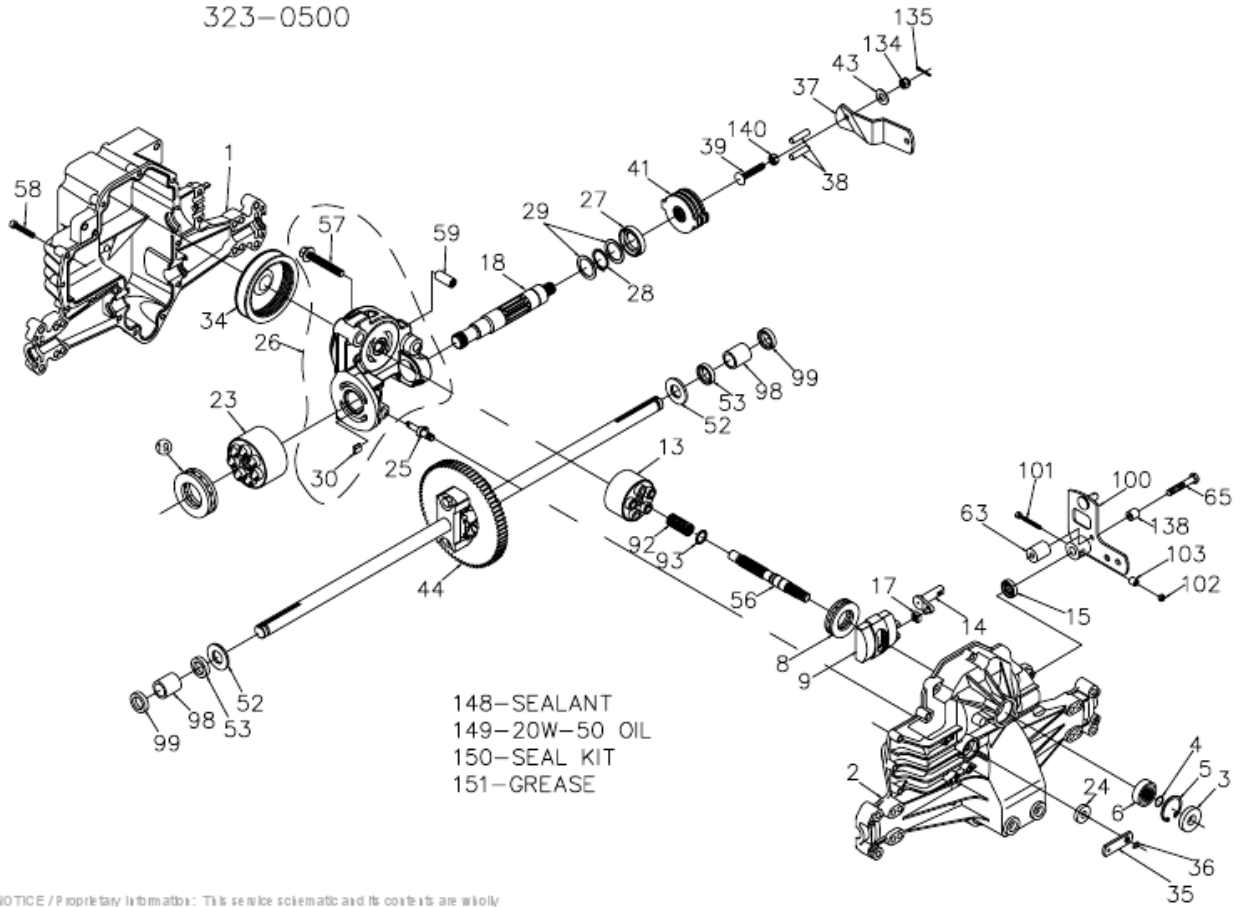

NOTICE / Proprietary Information: This service schematic and its contents are wholly owned by Hydro-Gear of Stillman, IL, and may not be published or reproduced without the written consent of Hydro-Gear.

Parts Breakdown

#	PART #	DESCRIPTION	QTY	Note
1	44863RM	HOUSING, 0500 LOWER (RAW MATL)	1	
2	70254	KIT, HOUSING, UPPER	1	
		UPPER HOUSING	1	
		TRUNNION JOURNAL BEARING	1	
3	9008000-0128	SEAL 15 X 35 X 7 LIP PTC	1	
4	2003016	RING RET 59 EXT WIRE	1	
5	2003052	RING RET 137 INT	1	
6	2003043	BEARING 15X35X11 BALL OPEN 6202	1	
8	50551	BEARING 30X52X13 BALL THRUST	1	
9	2003087	SWASHPLATE 10CC	1	
13	70331	KIT, BLOCK, 10CC CYLINDER	1	
		BLOCK-CYLINDER	1	
		PISTON	5	
		PISTON SPRING	5	
		PISTON SPRING WASHER	5	
14	2003005	ARM, TRUNNION, DOUBLE D	1	
15	9008000-0126	SEAL 12 X 25 X 7 LIP TC	1	
17	2000015	SLOT GUIDE	1	
18	50449	SHAFT, MOTOR 10 T PINI	1	
19	50552	BEARING 42X68X16 BALL THRUST	1	
23	70082	KIT, MOTOR BLOCK	1	
		BLOCK-CYLINDER	1	
		PISTON	7	
		PISTON SPRING	7	
		PISTON SPRING WASHER	7	
24	45074	SEAL 10 X 25 X 7 LIP	1	
25	2003555	ACTUATOR BYPASS	1	
26	70250	KIT, CENTER SECTION	1	
		PLATE, BYPASS	1	
		CHECK PLUG ASSEMBLY	2	
		CENTER SECTION	1	
		DU BEARING	1	
		BOLT, 3/8-24 X 2.5	3	
		BUSHING, 1.02 X 1.1 X .67	1	
27	45075	SEAL 26 X 42 X 8 LIP	1	
28	50007	RING RET 102 EXT	1	
29	44872	WASHER 1.04 X 1.37 X .04 FLAT	2	
30	70680	KIT, BYPASS PLATE	1	
34	50990	FILTER	1	
35	44866	ARM, BYPASS	1	
36	44870	RING RET 31 EXT	1	
37	50131	ARM, BRAKE	1	
38	44891	PIN .3 X 1.25 ACTUATING	2	
39	50316	SCREW 5/16-24 X 2 BRAKE	1	
41	70135	KIT, BRAKE ROTOR	1	
		BRAKE STATOR	4	

Parts Breakdown

#	PART #	DESCRIPTION	QTY	Note
		BRAKE ROTOR	2	
43	44130	WASHER .34 X .88 X .06	1	
44	70126	KIT, DIFF IHT	1	
		AXLE SHAFT	2	
		72T DIFFERENTIAL GEAR	1	
		DIFFERENTIAL HOUSING	2	
		14T BEVEL GEAR	2	
		10T PLANET GEAR	2	
		RETAINING RING	2	
		DIFFERENTIAL LOCKING BOLT	2	
		DIFFERENTIAL SPACER	1	
52	44875	WASHER .77 X 1.5 X .10 FLAT	2	
53	45076	SEAL- .75 X 1.25 X .250	2	
56	2003021	SHAFT PUMP	1	
57	50016	SCREW 3/8-24 X 2.5 HF W/PATCH	3	
58	44876	SCREW 1/4-20 X 1.37 THC	20	
59	50002	PIN .39 X .50 X 1.12 HOLLOW	2	
63	50156	SPACER .27X.60X.90	1	
65	44123	SCREW 1/4-20 X 2.0 SELF TAPPING	1	
92	2003014	SPRING, BLOCK	1	
93	2003017	WASHER .59 X .79 X .04 FLAT	1	
98	50137	BUSHING .75X1.0X1.1 STEPPED	2	
99	50941	SEAL .75 X 1 X .15 LIP	2	
100	50294	ASSEMBLY, CONTROL ARM	1	
101	50140	SCREW 10-24 X 1.5	1	
102	50141	NUT10-24 HEX LOCK (NYLON INSERT)	1	
103	50142	SPACER .2 X .37 X .36	1	
134	44142	CASTLE NUT, 5/16-24	1	
135	44101	PIN 3/32 X 3/4 COTTER	1	
138	23770	SPACER .27X.50X.40	1	
140	50269	NUT HEX 5/16-24	1	
148	50928	SEALANT TUBE	1	
149		20W-50 OIL	77oz	
150	70312	KIT, SEAL	1	
151	50416	GREASE TUBE CHEMPLUS 1-LP	1	