

210-3010L
Hydrostatic Transaxle
Service & Repair Manual

BLN-50334
January 2009

Table of Contents

| Description | Page |
|--------------------------------------|-------------|
| Introduction | 4 |
| General Description | 4-5 |
| Fluids | 5 |
| Safety Precautions | 6 |
| Maintenance | 6-7 |
| Oil & Filter Change | 7 |
| Parking Brake | 8 |
| Troubleshooting Diagram | 9 |
| Troubleshooting Chart | 10 |
| Minor Repairs | 11-18 |
| General Information | 11 |
| Shaft Seals | 11-12 |
| Charge Check Valves | 12-13 |
| Bypass Valve | 13 |
| Charge Pump | 13-14 |
| Axle Mounting Horn Assembly | 15-16 |
| Filter Base | 16 |
| Primary Components Replacement | 17-18 |

| Description | Page |
|--|-------------|
| Major Repairs | 19-31 |
| General Information | 19 |
| | |
| 210-3000 Axle Assembly | 19-26 |
| - Disassembly Procedures | 19-22 |
| - Reconditioning & Replacement of Components | 23 |
| - Assembly Procedures | 23-26 |
| | |
| BDU-10L-Transmission | 27-31 |
| - Disassembly Procedures | 27-28 |
| - Reconditioning & Replacement of Components | 29 |
| - Assembly Procedures | 29-31 |
| | |
| 210-3000 Parts Drawing & Parts List | 32-33 |
| | |
| BDU-10L Parts Drawing & Parts List | 34-35 |
| | |
| Product Line | 36 |

Introduction

The purpose of this manual is to provide information useful in servicing the 210-3010L Hydrostatic Transaxle. This manual includes unit and component description, troubleshooting, maintenance, and repair procedures.

A transaxle normally will not require servicing, other than recommended fluid and filter changes, if any, and an occasional brake adjustment during the life of the vehicle in which it is installed. Should other servicing be required, the unit must be removed from its installed location and thoroughly cleaned before beginning most procedures.

General Description

The 210-3010L Hydrostatic Transaxle is a self contained unit designed for the transfer and control of power. It provides an infinitely variable speed range between zero and maximum in both forward and reverse modes of operation.

The 210-3010L Hydrostatic Transaxle is a package consisting of two primary components, the 210-3000 axle assembly and the BDU-10L Hydrostatic Transmission.

The BDU-10L transmission is a "U" style transmission with a variable displacement pump and a fixed displacement motor. The variable displacement pump features a cradle swashplate with a direct-proportional displacement control. Reversing the direction of tilt of the swashplate reverses the flow of oil from the pump and thus reverses the direction of the motor output rotation. The fixed displacement motor uses a fixed swashplate. The pump and motor are of the axial piston design and utilize spherical nosed pistons which are held against a thrust race by internal compression springs.

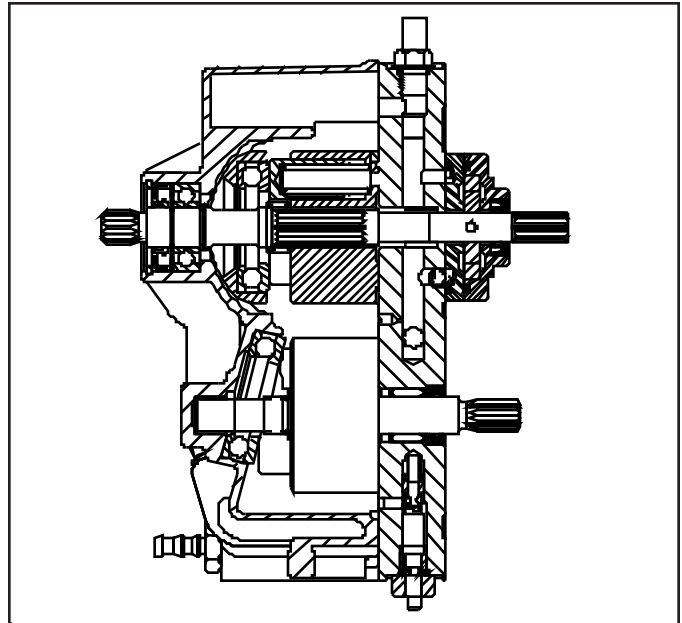

BDU-10L Transmission

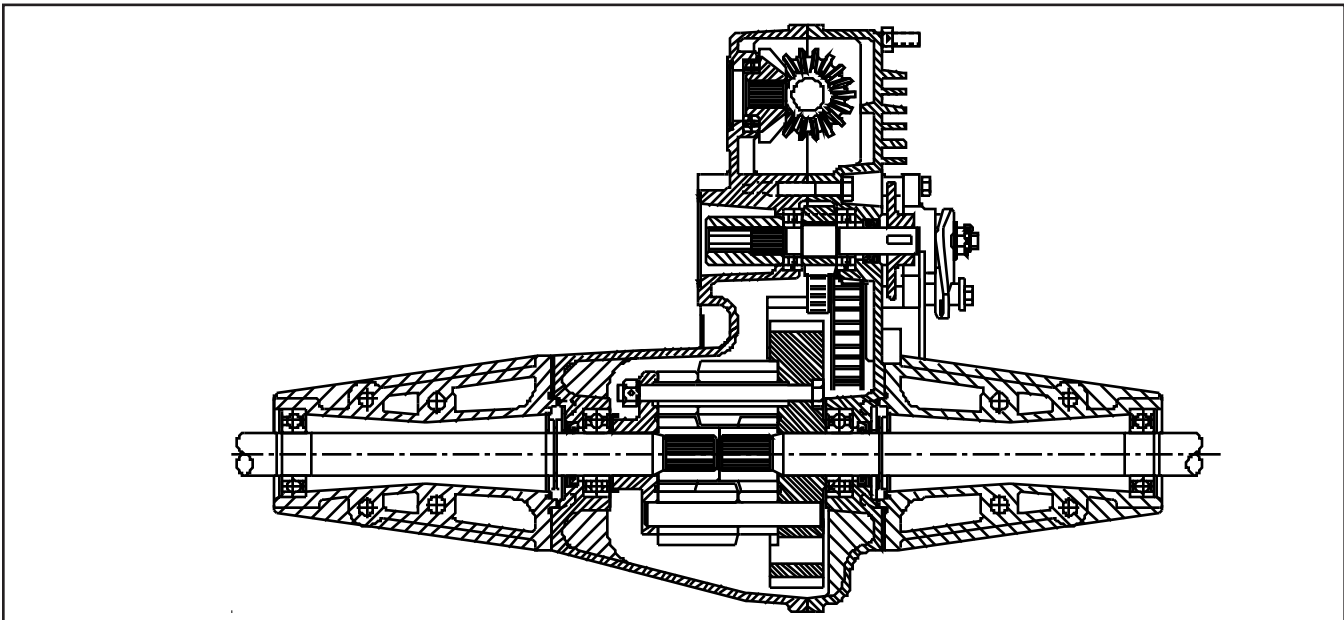

210-3000 Axle Assembly

The fluid supply for the BDU-10L transmission is shared by the axle. The oil passes from the axle housing through a filter prior to entering the transmission and feeding the fixed displacement gerotor charge pump. Excess fluid in the charge circuit is discharged over the charge relief valve back to charge pump inlet. Flow across a small fixed orifice connecting the charge circuit to the transmission housing supplements the cooling flow.

Charge check valves in the center section are used to control the makeup flow of fluid to the low pressure side of the loop.

A spool type bypass valve is utilized in the BDU-10L transmission to permit moving the vehicle for short distances at low speeds (2mph) (3.2km/hr) without starting the engine.

The 210-3000 axle assembly is a spur gear reduction transfer case with an integrated "heavy duty" spur gear differential.

The 210-3000 axle assembly utilizes an inline floating disc brake controlled by a "cam" style actuating arm.

Fluids/Greases

The fluids used in HYDRO-GEAR products have been carefully selected, and only equivalent, or better products should be substituted.

Typically, an engine oil with a minimum rating of 55 SUS at 210°F (98.9°C) and an API classification of SJ/CD is recommended. A 10W-40 engine oil has been selected for use by the factory and is recommended for normal operating temperatures. Another alternative that will provide excellent all climate performance and extended time between oil changes is a 15W-50 synthetic engine oil.

| SAE VISCOSITY GRADES | | | | |
|----------------------------|------------------|-----|-----|------|
| | | | | |
| | 10W-40 | | | |
| | 15W-50 Synthetic | | | |
| -35° | -5° | 15° | 60° | 100° |
| AMBIENT AIR TEMPERATURE °F | | | | |

The grease used in the manufacture of HYDRO-GEAR products is a Rykon Premium Grease and should be substituted for with equivalent products only if it is not readily available in your area. **NOTE:** This grease is not compatible with all grease types.

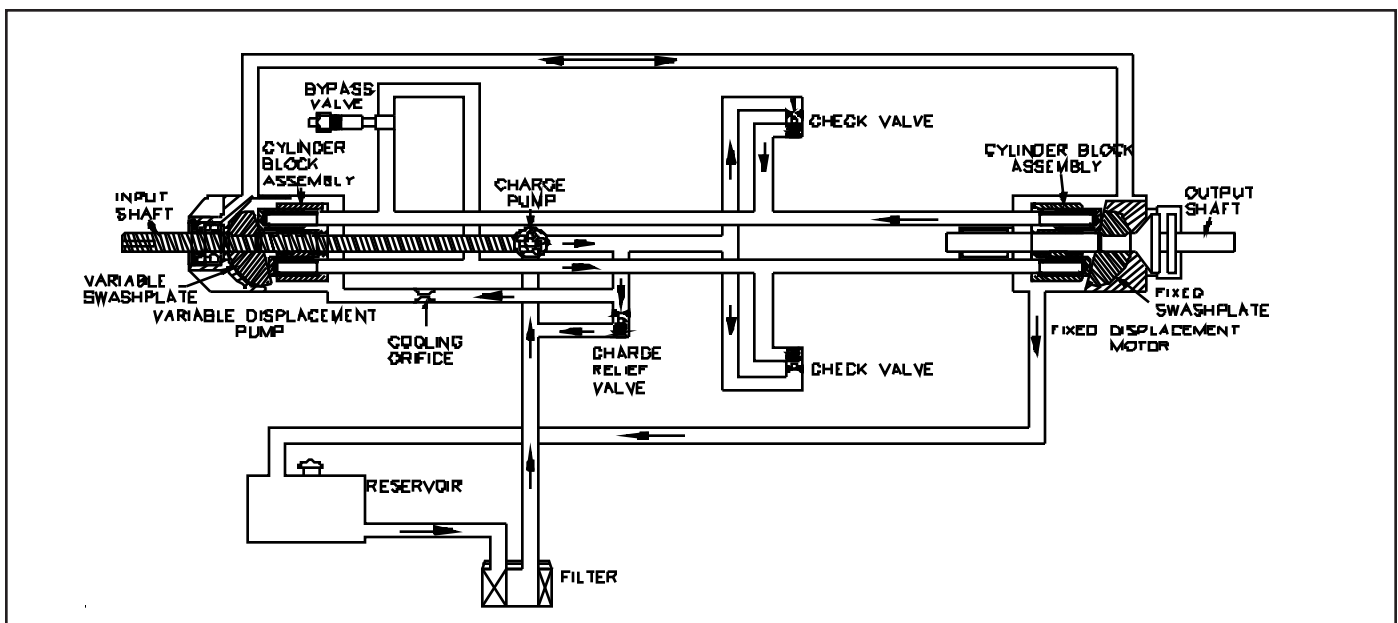

Hydrostatic Flow Illustration

Safety Precautions

Certain procedures may require the vehicle to be disabled (wheels raised off the ground, engine disconnected, etc.) in order to prevent possible injury to the technician and bystanders.

Some cleaning solvents are flammable. To avoid possible fire do not use cleaning solvents in an area where a source of ignition may be present.

The loss of hydrostatic driveline power may result in the loss of hydrostatic braking capacity. Proper brake maintenance becomes very important should this condition develop.

Maintenance

Check the transaxle cooling fan for broken or distorted blades, and check to see that the fan is securely fastened. Replace the fan if damaged.

Keep the transaxle clean. Grass clippings and dirt will effect the cooling efficiency of the fins on the transaxle housings. Avoid high pressure washing, compressed air is the preferred method of removing loose debris.

Inspect the brake for proper operation. If the brake fails to stop the vehicle or hold on a 30% slope, adjustments are necessary. You should make sure it fully disengages when the pedal is released.

Check to make sure the bypass valve and linkage is operational. The bypass valve should be fully released before operating the vehicle. It should extend approximately 0.22" (5.58 mm) from the hex nut.

Inspect the transaxle for leaks at the lip seals, damage to fittings, hoses, the filter, or to the housings. Check the oil level and add oil as necessary to bring it up to the proper level.

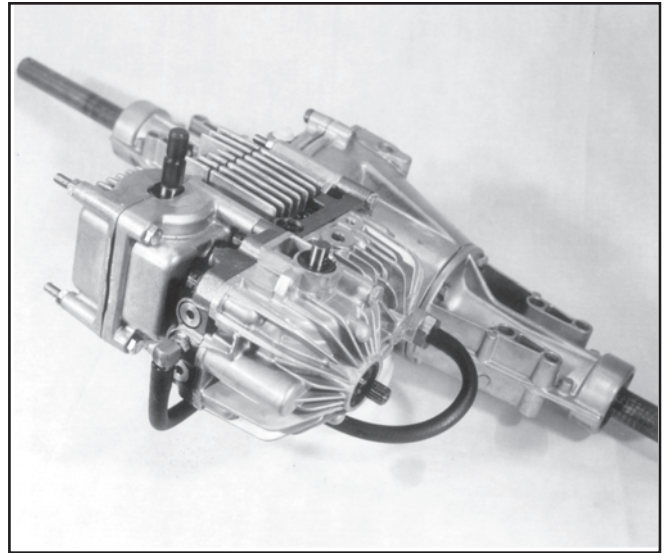

210-3010L Hydrostatic Transaxle

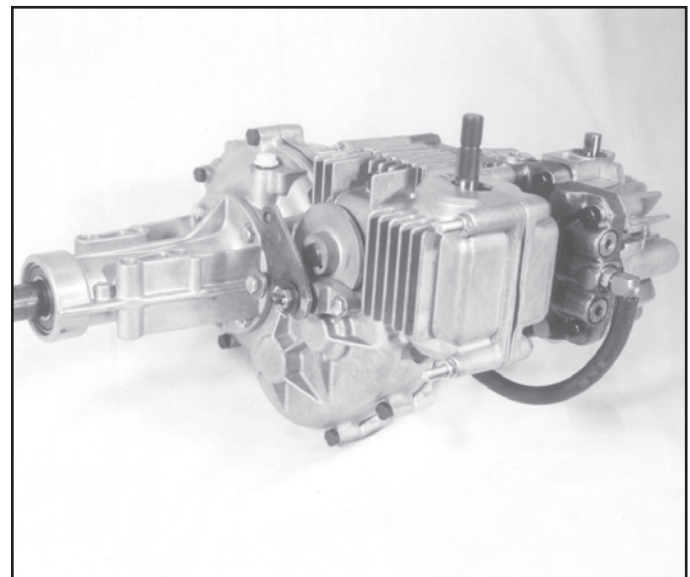

Oil & Filter Change

Oil and filter changes should occur approximately every 200 hours of operation or once each year.

More frequent oil and filter changes are recommended if operating conditions are severe or adverse, such as pulling a plow or a tiller for extended periods, or operating in very dusty conditions.

Refer to the following illustrations for the proper fill port and oil level port locations on your transaxle. These locations will be different on various models and it may be necessary to refer to the vehicle owners manual.

Configuration A. Remove the filter and allow the oil to drain through the filter mounting base. After the oil stops flowing you may install the new filter and tighten 3/4 of one turn after the filter seal touches the filter mounting base.

Configuration B. Drain the oil at bottom most fitting. Refer to vehicle owners manual for correct procedures.

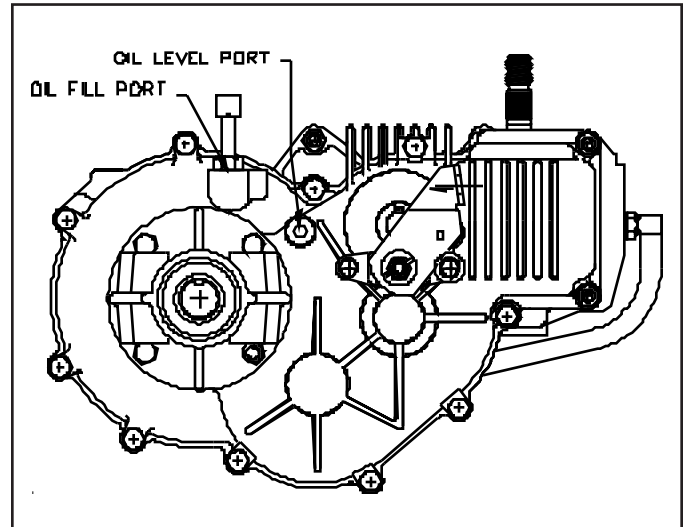

Configuration A

Refill the transaxle case to the correct level with the recommended oil type listed in the Fluids section (refer to illustrations for correct oil fill and oil level ports). The oil level should be rechecked after running the vehicle for a short time (1 minute will be adequate).

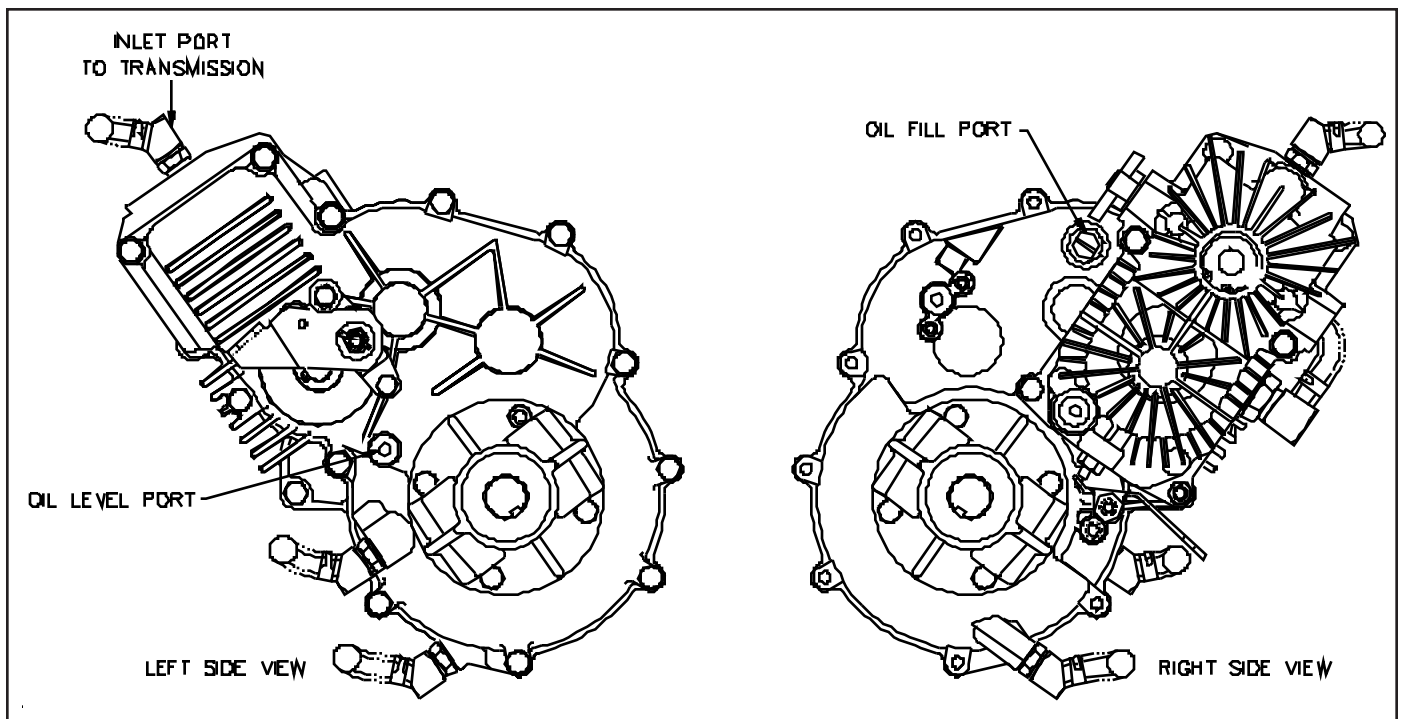

Configuration B

Parking Brake

The brake was factory set for a specific running clearance between the disc and pucks of 0.020" (.508 mm).

Place a feeler gage between the disc and one puck, if the clearance is not set properly remove the cotter pin retaining the castle nut and set the correct clearance by adjusting the castle nut accordingly. Reinstall the cotter pin.

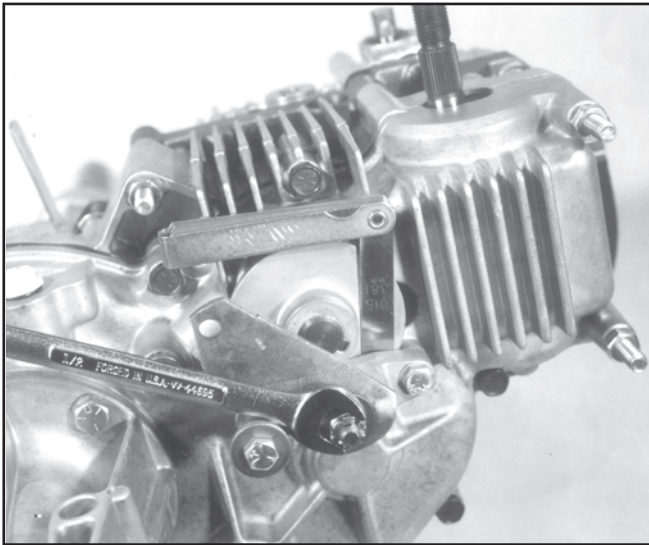

Brake Adjustments

If the correct adjustment was not achieved you will need to replace the brake pucks. Start by removing the cotter pin, castle nut, washer and brake actuating arm. Remove the brake yoke assembly and pull the disc from the shaft.

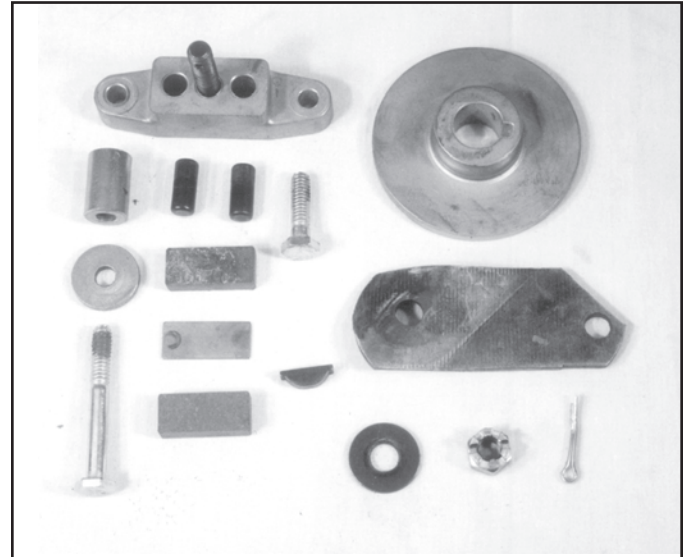

Brake Components

Clean the brake area and all components thoroughly with a degreasing solvent before reassembly.

During reassembly apply a **dry** graphite lubricant to the brake shaft, brake actuating pins and cam area of the brake actuating arm. Take precaution to not allow any lubricant onto the brake disc or pucks during reassembly.

Reassemble the brake with new pucks and torque the bolt and nut to 7-10 ft.lbs. (9.5-13.5 Nm).

Set the correct clearance (0.020") (.508 mm) and lock the castle nut with the cotter pin.

OPERATES IN ONE DIRECTION ONLY

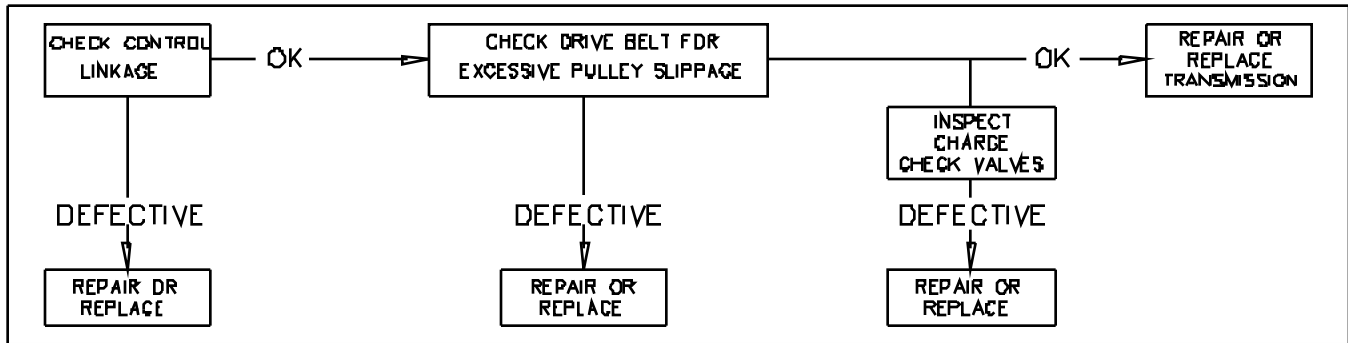

OPERATING HOT/LOSING POWER

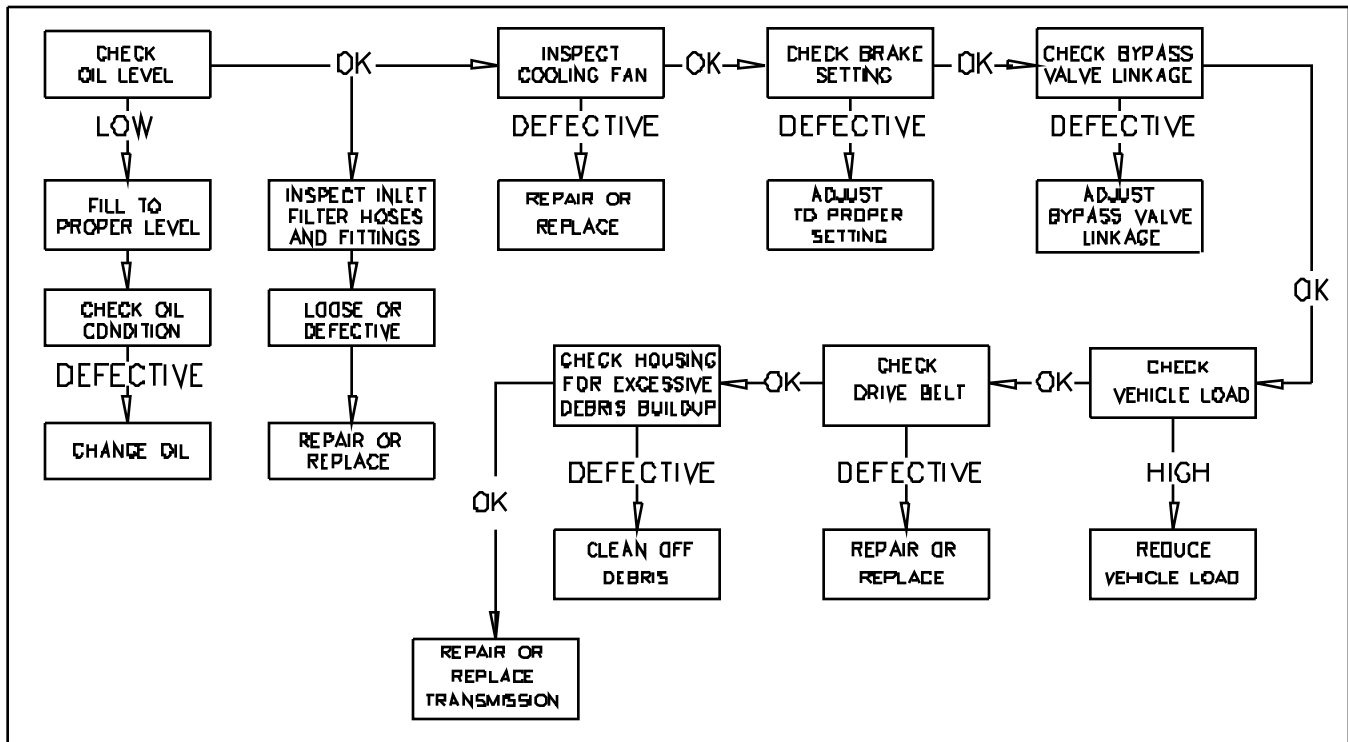

NOISY UNDER LOAD

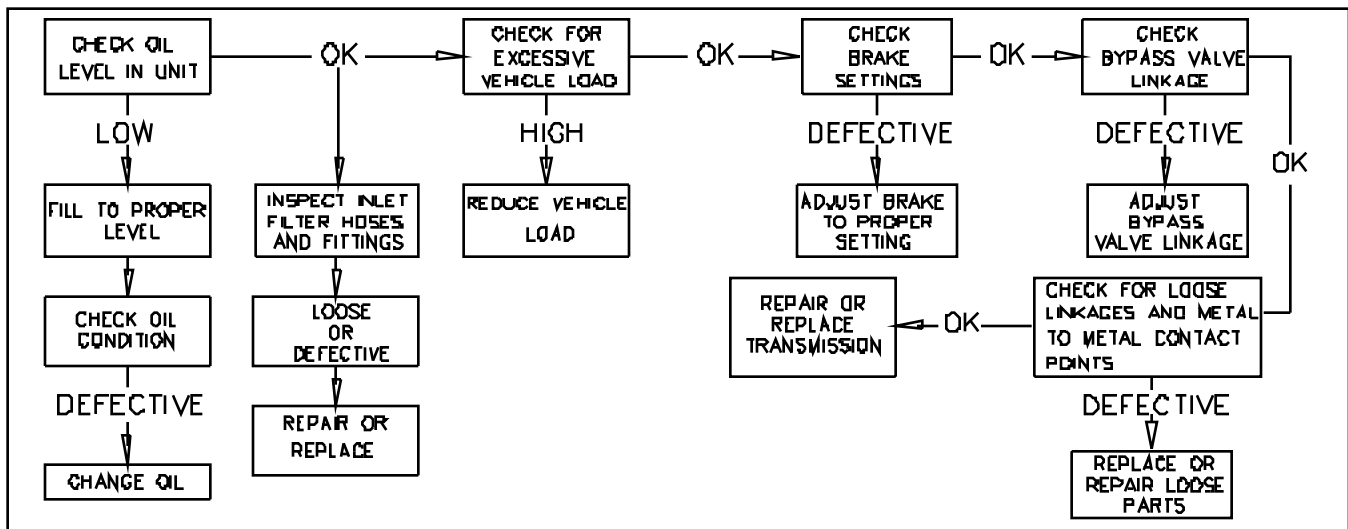

WARNING!!!
THE VEHICLE SHOULD BE ON LEVEL GROUND AND
THE ENGINE DISABLED BEFORE PERFORMING ANY ADJUSTMENTS

SYMPTOM - OPERATES IN ONE DIRECTION ONLY**POSSIBLE CAUSE**

- Inspect control linkage
- Inspect drive belt & pulleys
- Inspect check valves

CORRECTIVE ACTION

- Repair or replace
- Repair or replace
- Repair or replace

SYMPTOM - NOISY**POSSIBLE CAUSE**

- Check oil level & condition
- Check for excessive loading
- Check brake setting
- Check for loose parts
- Check bypass valve operation
- Check inlet flow conditions
- Inspect check valves

CORRECTIVE ACTION

- Fill to proper level or change oil
- Reduce vehicle loading
- Adjust brake to proper setting
- Repair or replace loose parts
- Repair or replace valve or linkage
- Repair or remove obstruction or leaks
- Repair or replace

SYMPTOM - LOW POWER**POSSIBLE CAUSE**

- Check engine RPM
- Check drive belt & pulleys
- Check oil level & condition
- Check for excessive loading
- Check brake setting
- Check for loose parts
- Check bypass valve operation
- Check inlet flow conditions
- Check operating temperature
- Inspect check valves

CORRECTIVE ACTION

- Adjust to correct setting
- Repair or replace
- Fill to proper level or change oil
- Reduce vehicle loading
- Adjust brake to proper setting
- Repair or replace loose parts
- Repair or replace valve or linkage
- Repair or remove obstruction or leaks
- Repair or replace unit
- Repair or replace

SYMPTOM - OPERATING HOT**POSSIBLE CAUSE**

- Check bypass valve operation
- Check for debris buildup
- Check oil level & condition
- Check for excessive loading
- Check brake setting
- Check cooling fan for damage
- Inspect check valves

CORRECTIVE ACTION

- Repair or replace
 - Clean off debris
- Fill to proper level or change oil
- Reduce vehicle loading
- Adjust brake to proper setting
- Repair or replace
- Repair or replace

Minor Repairs

General Information

Minor Repairs may be performed, following the procedures in this section, without voiding the unit warranty.

Cleanliness is a primary means of assuring satisfactory life on either new or repaired units. Cleaning parts by using solvent wash and air drying is usually adequate. As with any precision equipment, all parts must be kept free of foreign materials and chemicals.

Protect all exposed sealing surfaces and open cavities from damage and foreign material. The outer surfaces must be cleaned before beginning any repairs.

It is recommended that all O-rings and seals be replaced. Lightly lubricate all O-rings and seals with a clean petroleum jelly prior to assembly.

Each of the following repairs except brake adjustments will require the oil levels to be checked prior to operating the vehicle as some oil will be lost.

Plug/Fitting Torques

If any plugs were removed during servicing, they should be torqued as indicated in the accompanying table:

| TORQUE SPECIFICATIONS | | |
|-----------------------|---------------------------------|-----------------------------|
| OPERATION | TORQUE | PART DESCRIPTION |
| Bypass Plug | 84-120 in lbs (9.5-13.5 Nm) | 7/16-20 SAE Straight Thread |
| Check Plug(s) | 180-240 in lbs (20-27 Nm) | 9/16-18 SAE Straight Thread |
| Steel Plug/Fitting | 96-120 in lbs (10.8-13.5 Nm) | 7/16 SAE Straight Thread |
| Steel Plug/Fitting | 180-240 in lbs (20-27 Nm) | 9/16 SAE Straight Thread |
| Steel Plug/Fitting | 180-240 in lbs (20-27 Nm) | 3/4 SAE Straight Thread |
| Steel Plug/Fitting | 180-240 in lbs (20-27 Nm) | 7/8 SAE Straight Thread |

Shaft Seals

Lip type seals are used on the pump input shaft, pump through shaft (not all models use the through shaft), motor output shaft and displacement control shaft of the BDU-10L, as well as on the brake shaft and axle shafts (in the main housing halves only) of the 210-3000. These seals can be replaced without major disassembly of the unit. However, replacement of the seals generally requires removal of the transaxle from the machine.

To replace the pump input shaft seal, first remove the retaining ring from the housing.

Carefully pull the seal out of the housing bore. A "hook" type tool may be used to grasp the seal and pull it out, or a slide hammer type puller may be used to remove the seal. Care must be taken so as not to damage the housing bore, shaft sealing surface, or bearing. Once removed, the seal is not reusable.

Inspect the sealing area on the shaft for rust, wear, or contamination. Polish the sealing area on the shaft if necessary.

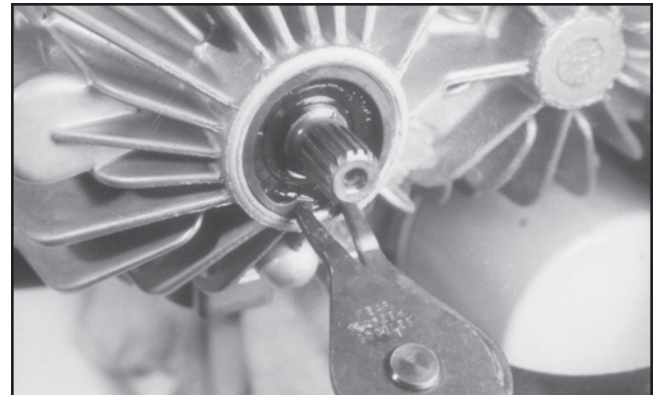

Retaining Ring Removal

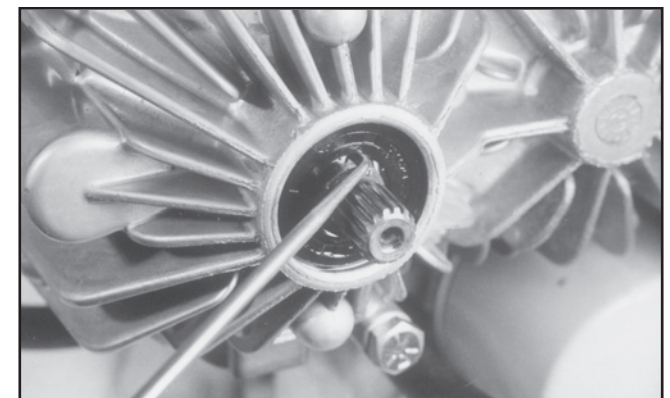

Lip Seal Removal

Shaft Seals

Lubricate the new seal with petroleum jelly.

Wrap the spline or key end of the shaft with with a thin plastic or cellophane to prevent damage to the seal lip during installation.

Slide the seal over the shaft and press it into the housing bore. Be careful not to damage the seal.

Install the retaining ring in the housing.

The pump through shaft, motor output shaft, displacement control shaft, and brake shaft seals may be replaced by following a similar procedure as outlined for the pump input shaft seal. These seals are not held in position by a retaining ring. The replacement of axle shaft seals requires the removal of the axle mounting horn while the replacement of the seals on pump through shaft and the motor output shaft requires removal of the BDU-10L from the 210-3000 axle assembly.



Lip Seal Installation



Retaining Ring Installation

Charge Check Valves

Remove the check valve plug with a 1/4" internal hex wrench.

Remove the check valve spring and check ball (or poppet) from the center section.

CAUTION: Do not allow the check ball to fall into the closed loop passages in the center section. Removal may be difficult but can be accomplished with a magnet, or by removing the plug from the end of the center section. Do not allow contaminants to be introduced to the system.

Inspect the check balls (or poppets) and mating seats in the center section for damage or foreign material.

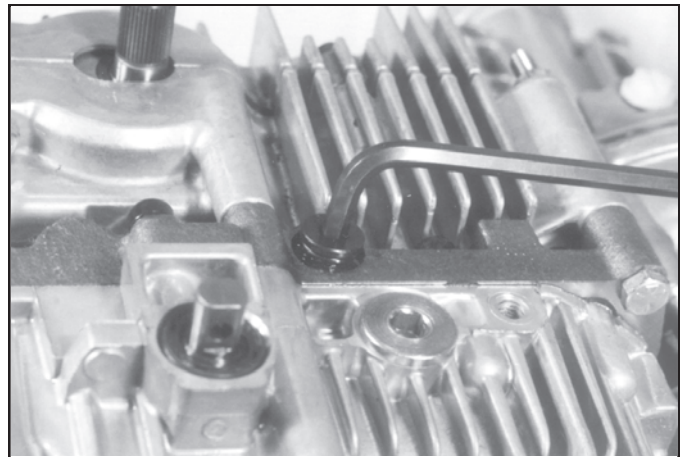

Check Valve Removal/Installation

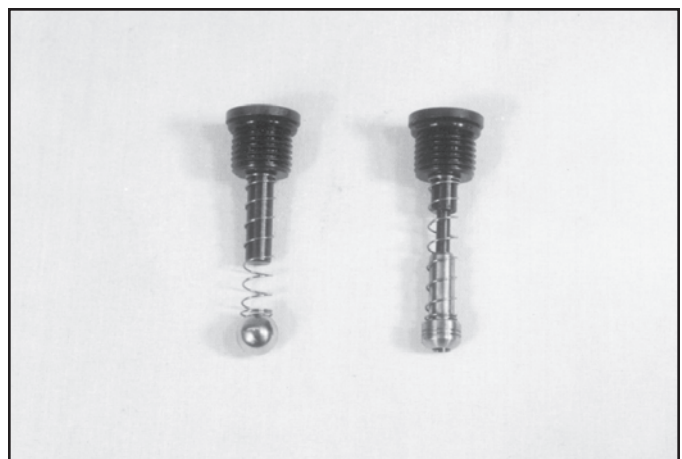

Check Valve Options

Position the transmission so that the check valve port will be in the upright position (as shown) and install the check ball (or poppet), spring and plug (with o-ring) into the center section. Make sure the plug stem is properly positioned into the poppet or damage and failure will occur. Be certain the check ball does not fall into the closed loop passage.

Torque the plug to 15-20 ft.lbs. (20-27 Nm).

Turn the unit over and repeat the procedure for the other side.

Bypass Valve

Removal of the bypass valve will require the BDU-10L to be removed from the 210-3000 axle assembly.

Remove the bypass valve plug with a 9/16" hex wrench.

Remove the bypass valve plug, spool and spring from the transmission center section.

Inspect the valve spool and mating bore in the center section for damage or foreign material. The spool must move freely. It is recommended that the o-rings be replaced.

Retain the valve spring to the valve spool with petroleum jelly. Install the valve spool, spring and plug (with o-ring) into the center section. Torque the plug to 7-10 ft.lbs. (9.5-13.5Nm).

Depress the bypass valve several times to insure that it operates smoothly and fully closes. The bypass "button" should extend from the hex plug approximately 0.22" (5.58 mm) when fully released (closed).

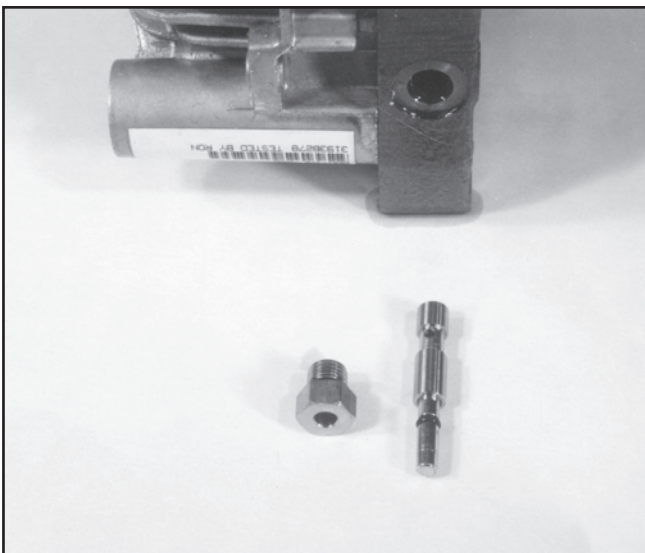

Bypass Valve

Charge Pump Disassembly

Repair to the charge pump will require the BDU-10L transmission to be removed from the 210-3000 axle assembly.

The correct charge pump orientation is determined by the rotation of the pump shaft (CW or CCW).

Before removing the charge pump, make note of, or mark its position to simplify the reassembly process.

Using a 5mm internal hex wrench, remove the two screws holding the charge pump cover on.

Remove the charge pump cover and o-ring. Avoid turning or twisting the charge cover during removal, or damage to the charge relief spring may occur.

Remove the charge pump gerotor assembly.

Standard Charge Pump Cover Orientation

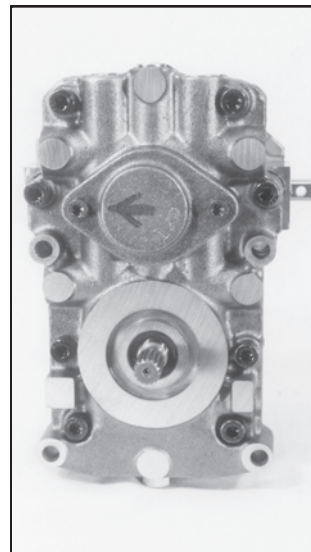

(CW)

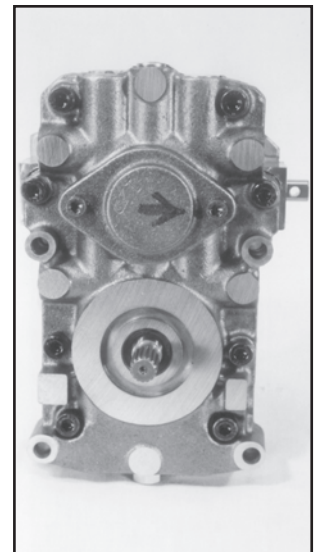

(CCW)

Charge Pump Disassembly

For models with a through shaft: Remove the charge pump drive pin, spacer plate and o-ring. Make note of, and/or mark the top and/or bottom of the spacer plate.

Remove the charge relief valve spring and ball.

Inspect the gerotor assembly, charge pump cover, and center section (or spacer plate) for abnormal wear, damage or foreign material. Inspect the charge relief valve ball and spring. Inspect the charge relief valve seat in the center section for damage or foreign material.

Charge Pump Assembly

Prior to reassembly of the charge pump, apply a small quantity of petroleum jelly to the I.D., O.D., and faces of the gerotor assembly.

NOTE: Improper assembly of the charge relief valve spring and ball, or the incorrect orientation of the spacer plate and cover will cause a priming failure. If assembled properly, the charge pressure should be maintained at 25-70 PSI (1.7-4.8 bar) at 3000 RPM pump speed.

For Standard Charge Pump: Install the charge relief valve spring and ball. Install the gerotor assembly. Install a new o-ring and the charge pump cover. **NOTE:** The charge relief spring must enter the recessed hole in the charge pump cover. Torque the bolts evenly to 7-10 ft.lbs. (9.5-13.5 Nm).

For Through Shaft Charge Pumps: Install the charge relief valve spring and ball. Install a new o-ring and the spacer plate onto the aligning pins. **NOTE:** The charge relief spring must enter the recessed hole in the spacer plate. Install the charge pump drive pin. Install the gerotor assembly. Install a new o-ring and charge pump cover. Torque the bolts evenly to 7-10 ft.lbs. (9.5-13.5 Nm).

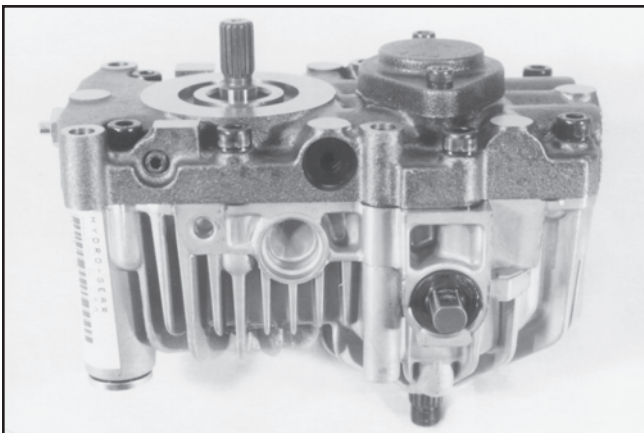

BDU-10L With Standard Charge Pump

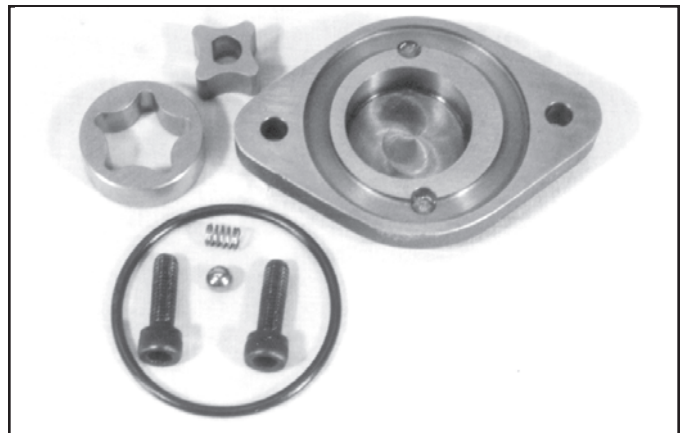

Standard Charge Pump Components

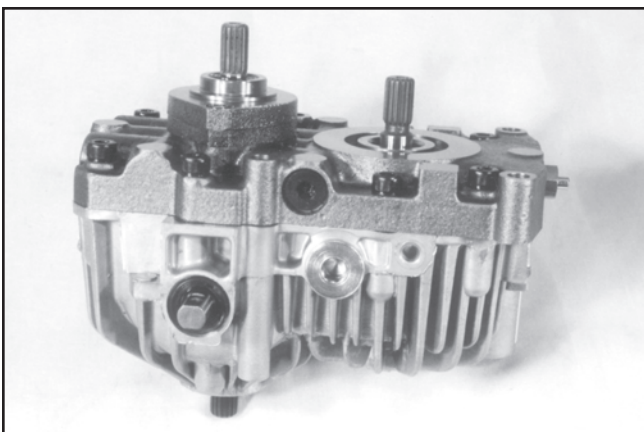

BDU-10L With Through Shaft Charge Pump

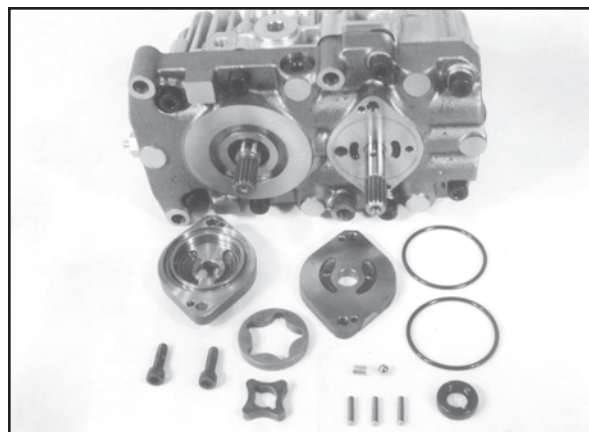

Through Shaft Charge Pump Components

Axle Mounting Horn Assembly

Replacement of the axle mounting horn assembly can be accomplished with a minimum loss of oil if the 210-3010L transaxle is removed from the vehicle and situated with the axle assembly to be replaced in the upright position.

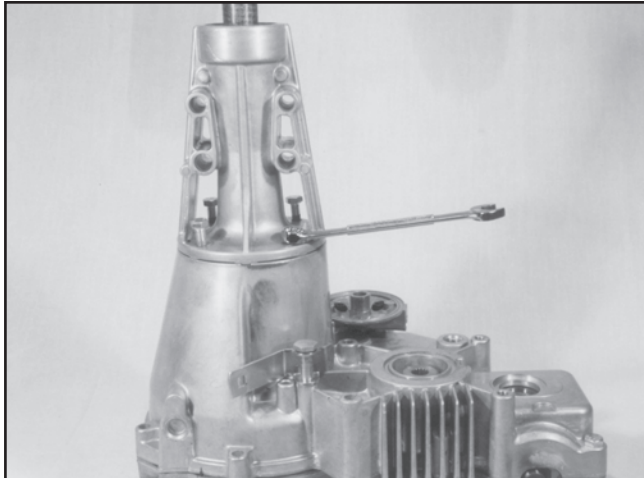

Axle Mounting Horn Removal

Using a 1/2 inch wrench (or socket) remove the four fasteners (4 bolts used on one assembly - 3 bolts and 1 nut used on the other side) securing the assembly to the main housing.

Make note or mark the orientation of the axle mounting horn before removal.

Remove the axle mounting horn assembly and two washers from the axle.

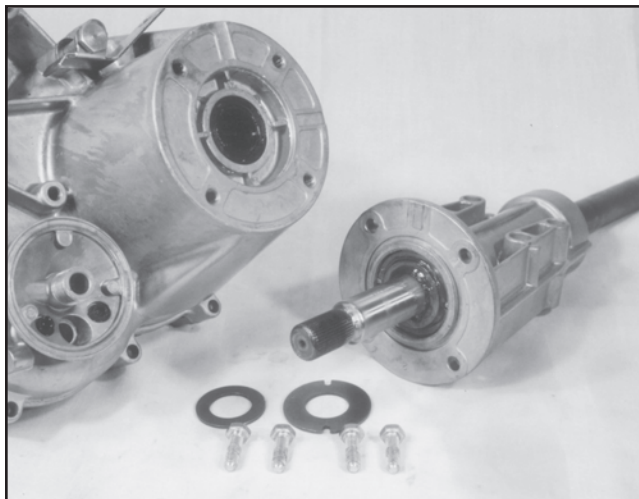

Axle Mounting Horn Components

Replace the seal in the housing prior to reassembly. Refer to page 11 for seal replacement instructions.

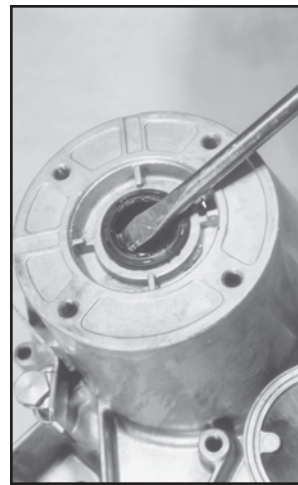

Lip Seal Removal

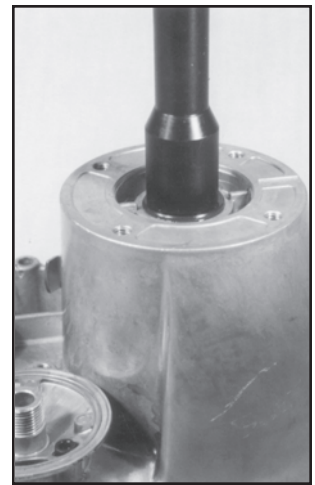

Lip Seal Replacement

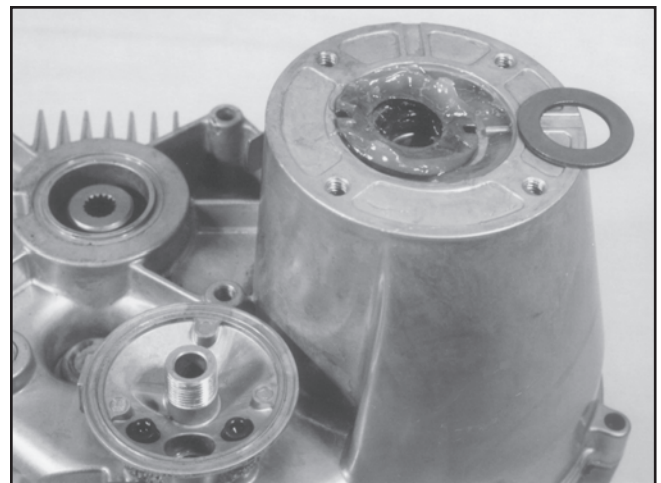

Pack Pocket Area with Grease and Install Washers

Fill the washer pocket area with Rykon Premium Grease or an equivalent product.

Install washer aligning notches with ribs in pocket of main housing. Install washer on top of "notched" washer.

Install O-ring onto axle mounting horn assembly.

Axle Mounting Horn Assembly

Use caution while installing the replacement axle mounting horn assembly to avoid damaging the new seal. Make sure the notches in the washer remain engaged to the tabs in the mounting horn assembly during installation. Rotate the axle as you are installing the assembly to allow the splined end of the axle to engage into the splined gears of the differential assembly. When properly aligned it should slide in freely and the axle horn should seat down onto the main housing and engage into an anti-rotational slot.

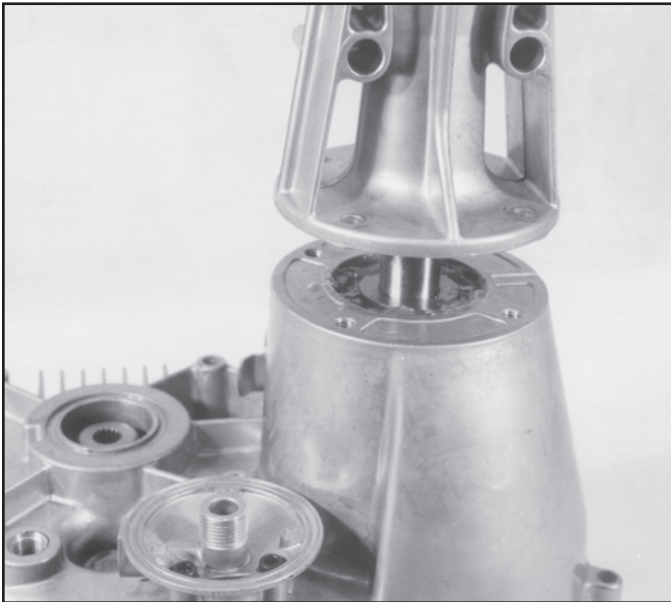

Install Axle Horn

Install four new fasteners or apply Loctite #242 (or equivalent) to the original fasteners and torque to 13-15 ft. lbs. (17.6-20Nm).

Filter Base Replacement

NOTE: Not all models have the filter base mounted to the transaxle so these procedures may not apply to your vehicle. Refer to your vehicle manual.

Replacement of the filter base or filter base gasket can be accomplished with the transaxle still in the vehicle in many cases, but will require draining the oil from the transaxle.

Remove the filter and allow the oil to drain from the transaxle housing.

Remove the two internal hex head screws retaining the filter base to the axle housing.

Remove the filter base and gasket.

Unscrew the filter base from the 7/16 SAE barbed fitting and hose.

NOTE: It is recommended to not remove the hose from the barbed fitting while changing filter bases.

Screw the new filter base onto the 7/16 SAE barbed fitting and hose. Torque the fitting to 4 - 6 ft. lbs. (5.4-8 Nm).

Install the filter base and a new gasket with the two screws and torque the screws to 7 - 10 ft. lbs. (9.5-13.5 Nm).

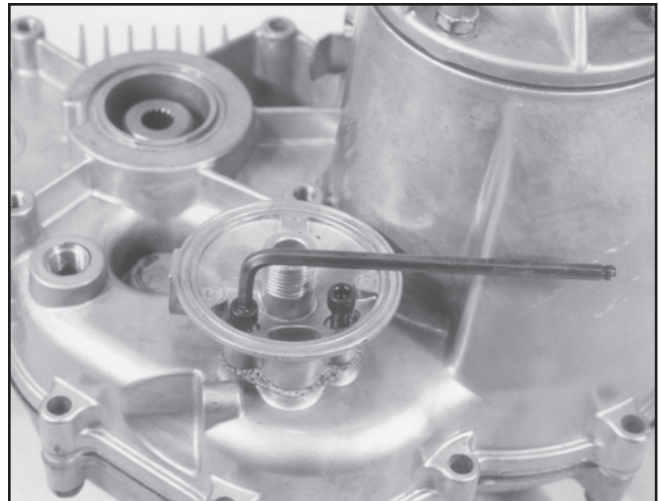

Filter Base Removal



Filter Base Components

Primary Component Replacement

Once it has been determined through troubleshooting that either the BDU-10L or the 210-3000 is defective, the defective component must be replaced following the procedures outlined in this section.

Remove the transaxle from its installed location and remove any external components such as a cooling fan and input pulley or frame mounting hardware.

Remove the oil lines (hoses and fittings) and the oil filter from the transaxle so that as much oil as possible can be drained from the housings.

NOTE: Hoses may have to be removed from some fittings in various models. If hoses are removed from the fittings, new hoses and fittings will be necessary during reassembly to prevent leaks and possible failure.

The oil lines and fittings must be replaced if damaged in any way.

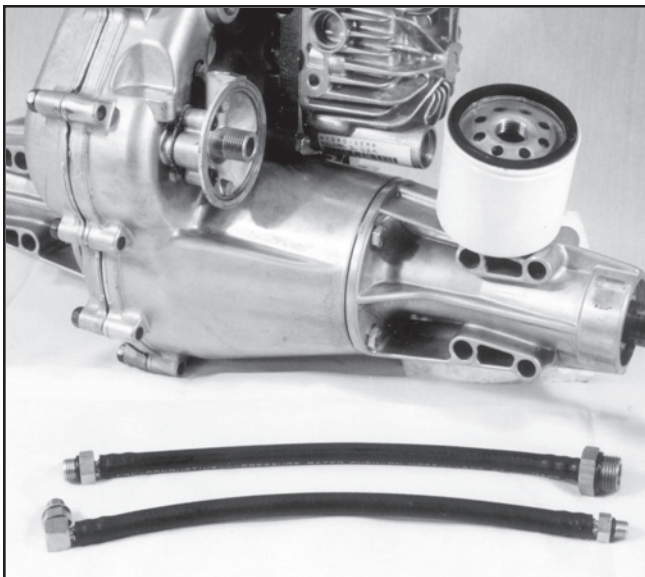

Oil Lines, Fittings and Filter Removal

Using 1/2 inch wrench (and/or socket) remove four mounting bolts holding the BDU-10L transmission in position on the 210-3000 axle assembly. One location uses a “lock-nut” also.

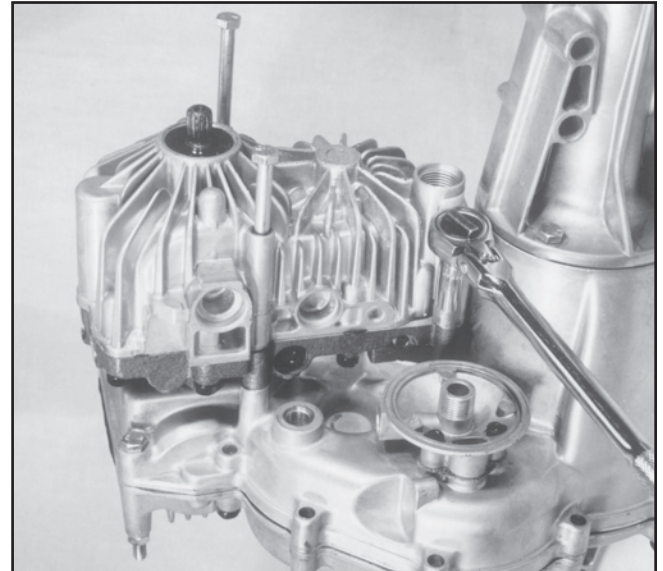

Remove Four Mounting Bolts

The BDU-10L should slide freely away from the 210-3000. If necessary you may carefully pry the two components apart by applying pressure with a long straight blade screw driver.

Use caution to avoid damaging either component.

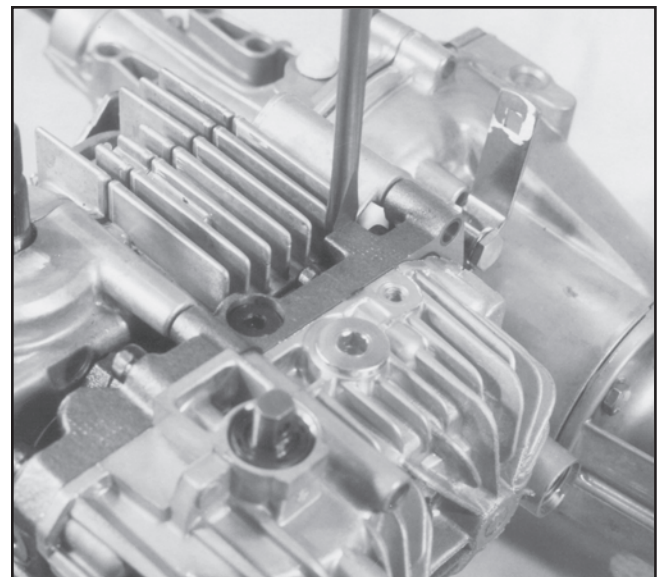

Remove BDU From Axle Assembly

Primary Component Replacement

An o-ring and a quad ring are used to seal between the two components. These are to be replaced with new parts during reassembly.

NOTE: The quad ring is used on the through shaft version only.

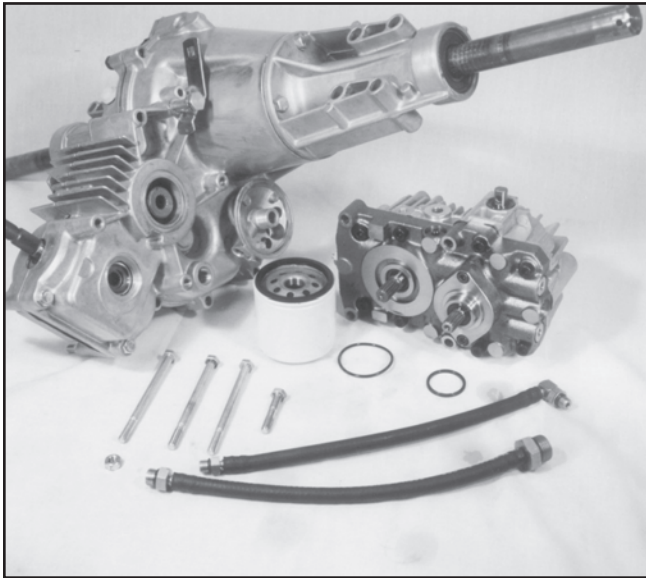

Primary Components and Assembly Hardware

Installation of the BDU-10L onto the 210-3000 will be easiest with the BDU mounting surface positioned facing up.

Place a new O-ring and new quad-ring into position on the 210-3000.

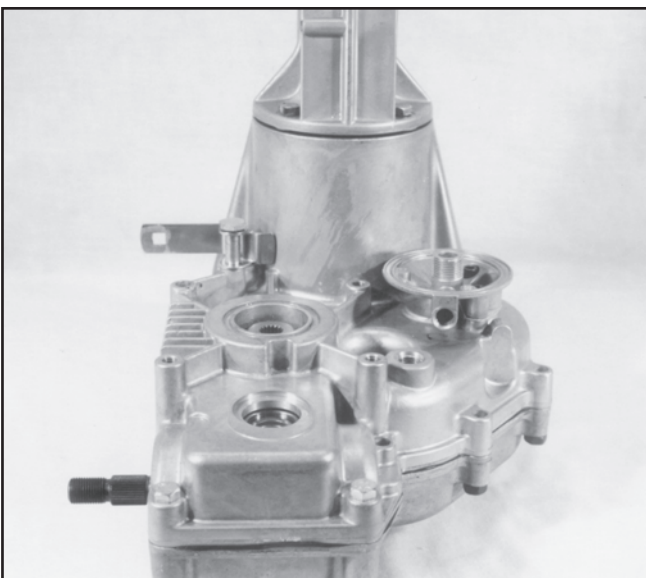

210-3000 Positioned for Reassembly

Install the BDU-10L, aligning the splined shaft ends with the splined coupling and splined input pinion gear of the 210-3000. The two shafts should slide freely into place or damage could occur. Do not force the BDU-10L down. If they do not slide together freely, remove it and try again.

Alignment of splines may be accomplished by rotating the brake disc and the input shaft.

Install the four bolts (and one nut) and torque to 13-15 ft.lbs. (17.6-20Nm).

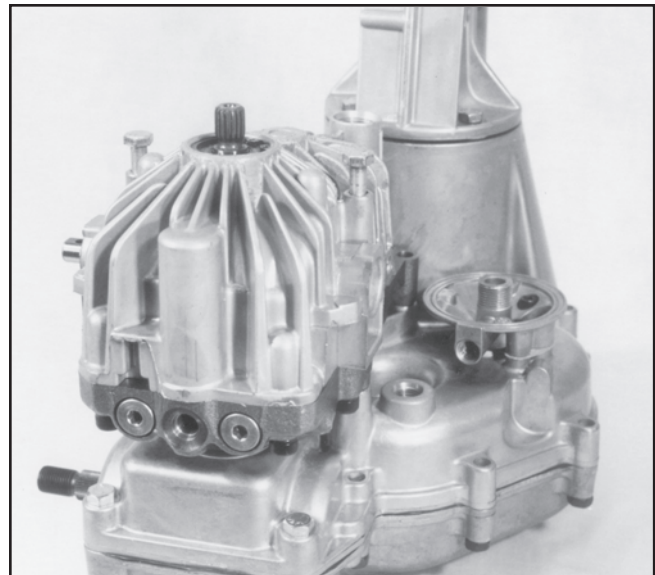

BDU-10L Installation

Install the oil lines and fittings.

Fill with oil as described in the Maintenance section covering oil and filter change.

Major Repairs

General Information

Major Repairs described in the following sections are for the complete disassembly and reassembly (Major Repair) of the 210-3010L Transaxle and will void all product warranty, unless license to perform said Major Repairs was previously obtained from an Authorized Representative of HYDRO-GEAR.

Cleanliness is a primary means of assuring satisfactory life on repaired units. Cleaning parts by using solvent wash and air drying is usually adequate. As with any precision equipment, all parts must be kept free of foreign materials and chemicals.

Protect all exposed sealing surfaces and open cavities from damage and foreign material. The outer surfaces should be cleaned before beginning any repairs.

It is recommended that all O-rings and seals be replaced. Lightly lubricate all O-rings and seals with a clean petroleum jelly prior to assembly.

It is recommended that parts requiring replacement be replaced with the complete assembly (kit) as shown in the Service Parts Drawings on pages 32-35.

Prior to performing Major Repairs on the 210-3010L Hydrostatic Transaxle, remove the transaxle from its installed location and remove any external components such as a cooling fan and input pulley or frame mounting hardware.

NOTE: Thoroughly clean all exposed surfaces prior to any further disassembly.

Remove the oil lines (hoses and fittings) and the oil filter from the transaxle as described in the Minor Repair section so that as much oil as possible can be drained from the housings.

Remove the BDU-10L transmission as described in the Minor Repair section.

Remove the parking brake components as described in the Maintenance section.

Remove the axle carrier mounting horns as described in the Minor Repair section. Make note of the orientation or mark the mounting horn before removal.

210-3000 Disassembly Procedures

Position the left hand housing assembly with the BDU-10L mounting surface down (Take care to avoid damage to the axle carrier assembly mounting surface). This places the right hand housing assembly up and allows access to the housing assembly bolts.

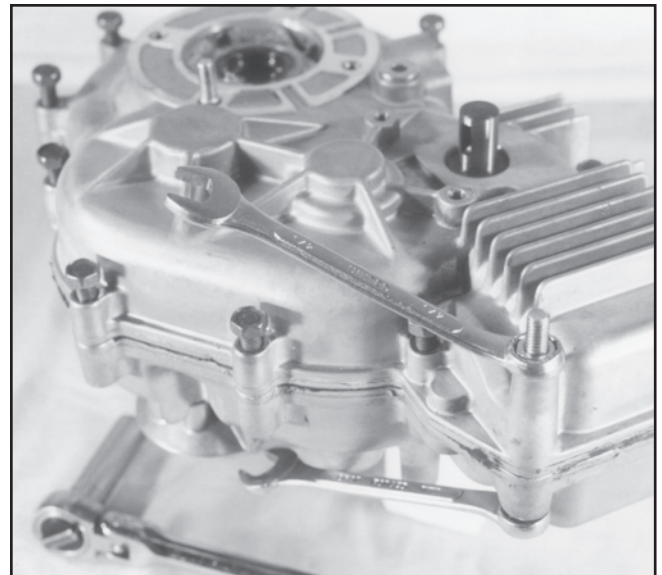

Remove Axle Assembly Bolts

210-3000 Disassembly Procedures

Using 1/2 inch wrench (and/or socket) remove two torque strap mounting bolts and locknuts from the housing end opposite from the differential (front).

Using 1/2 inch wrench (and/or socket) remove the eleven housing assembly bolts.

Separate the two housing halves by applying pressure (as shown) with two large straight blade screw drivers. Use caution to prevent damage to the mating sealing surfaces as you separate the housings. The sealant will make it difficult to separate the two halves.

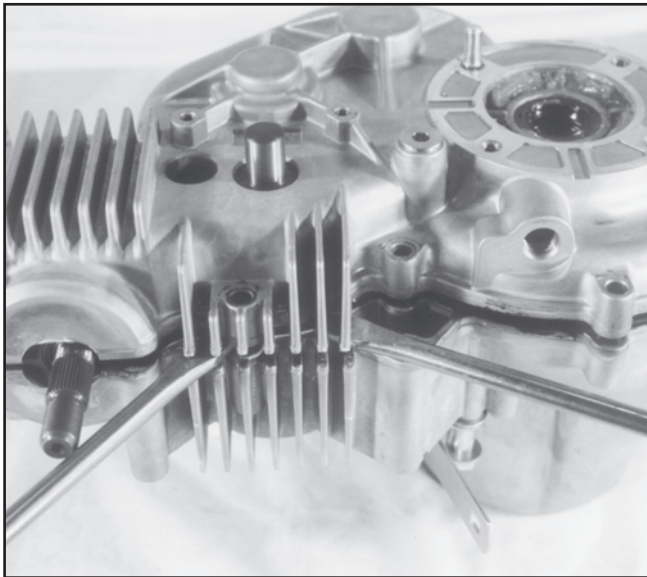

Separating Housing Halves

It may be necessary to tap lightly on the exposed end of the brake shaft assembly as the housings are being separated so that it remains in the left hand housing (lower half).

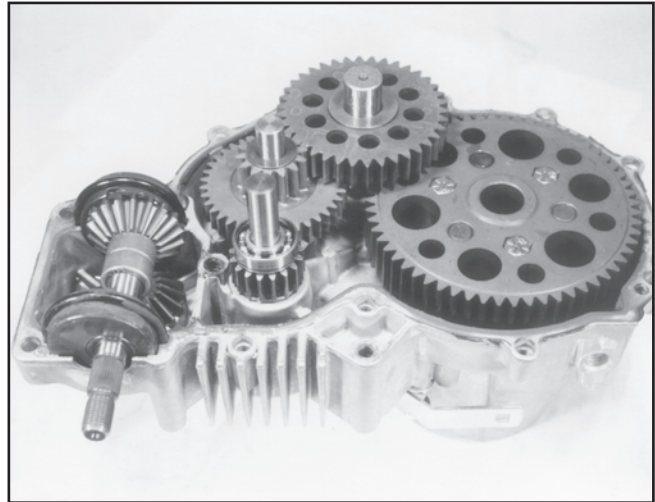

Left Hand Housing and Components

Final Drive Pinion Assembly

Remove the final drive pinion assembly and washer.

Inspect the teeth (internal and external) for damage or unusual wear and replace as necessary.

Inspect the bearing surfaces of the shaft for damage or unusual wear. If the shaft is found to need replacing the mating parts may also require replacement.

Inspect the washers for unusual wear.

Replacement of complete assemblies is recommended.

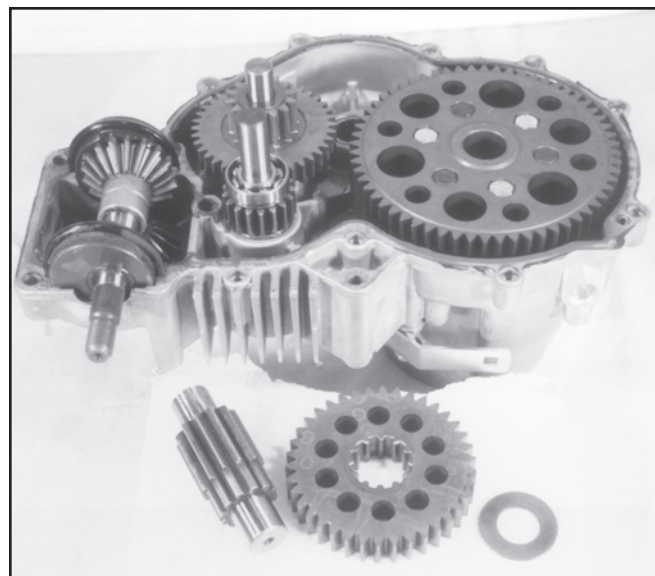

Removal of Final Drive Pinion

Differential Assembly

Remove the differential assembly and triangular washer from the housing.

Inspect the 60t gear teeth for damage or unusual wear.

Inspect the 10t planet gears for damage or unusual wear. Roll the gears to check for proper operation.

Inspect the axle bore in the 60t gear and the axle bore in the end cap for unusual wear.

Check the bolts for proper torque of 25-32 ft.lbs. (34-43Nm).

If damage or unusual wear is found in any of the components, replacement of the entire assembly is recommended.

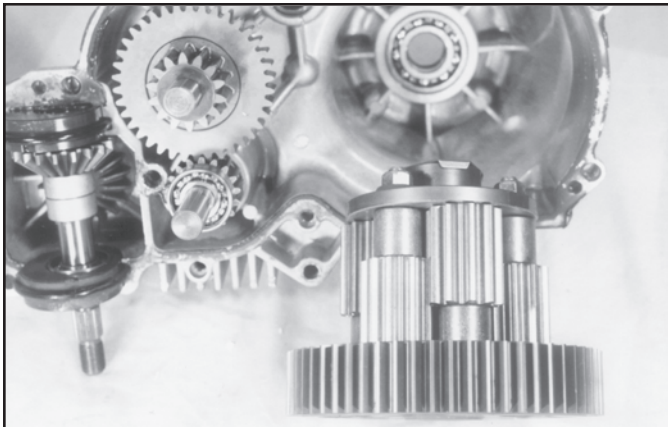

Removal of Differential Assembly

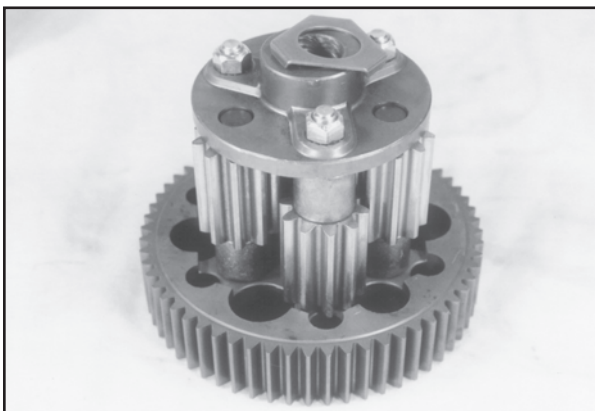

Differential Assembly

Reduction Gear/Jack Shaft & Brake Shaft Assembly

It may be necessary to remove these assemblies at the same time because of an overlapping condition (only if the jack shaft will not pull out of the reduction gear freely).

Inspect gear teeth for damage or unusual wear.

Inspect the internal splines of the reduction gear and the splines on the jack shaft for wear.

Inspect the bearing surfaces at the end of the jack shaft for damage or unusual wear, if the shaft is found to need replacing, the mating parts may also require replacement.

Inspect the brake shaft bearings and the coupling for damage or unusual wear and replace as necessary.

NOTE: The coupling is designed as a press fit onto the shaft. Over time the splines may wear and the coupling will become loose. If the coupling is not a press fit onto the brake shaft, replacement is recommended.

Inspect the washers for unusual wear.

Replacement of complete assemblies is recommended.

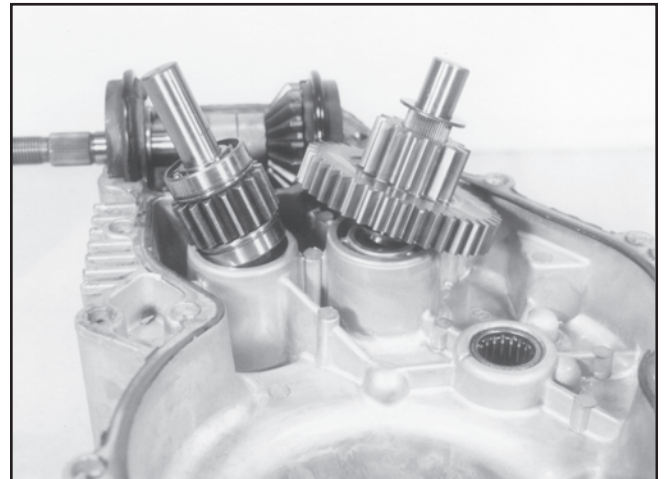

Removal of Reduction Gear and Brake Shafts

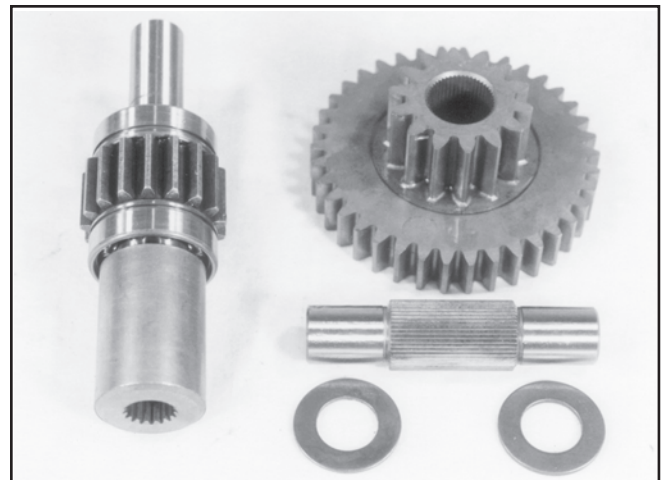

Reduction Gear and Brake Shaft

210-3000 Disassembly Procedures Input Shaft Assembly

(Not used in all models)

Removal of the input shaft assembly will require applying pressure onto the end of each bearing retainer while lifting the assembly from the housing (the top bearing retainer has a wave style spring washer in it to make up any end play). The use of gasket sealant in this area may make it difficult to remove this assembly without the use of a pry tool (as shown).

Inspect each component for damage or unusual wear and replace as necessary.

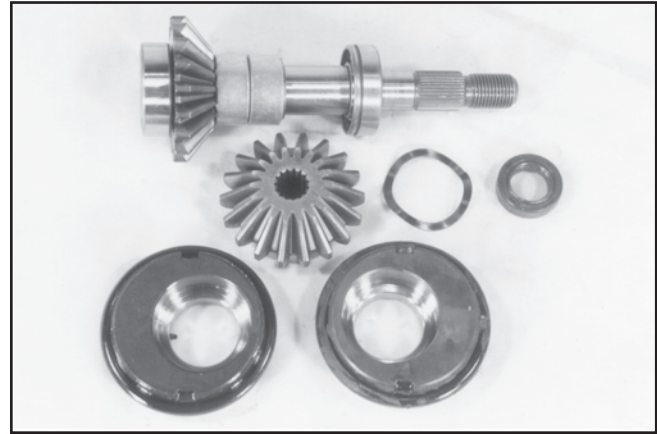

Input Shaft and Input Pinion Components

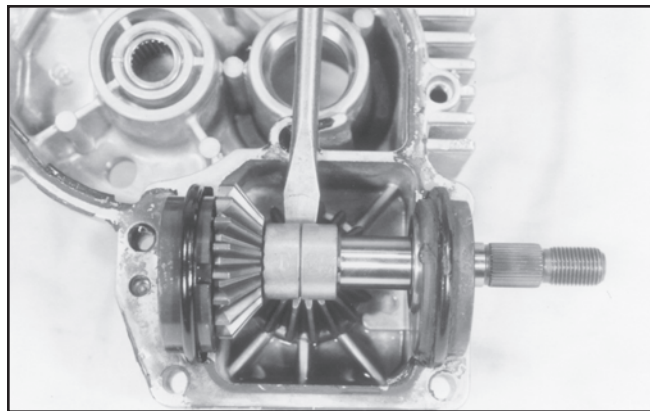

Removal of Input Shaft Assembly

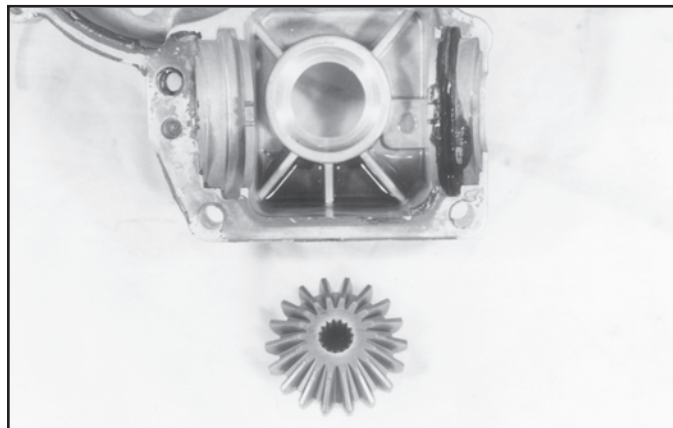

Input Pinion Removal

Input Pinion Assembly

(Not used in all models)

The input pinion assembly may be pressed out of the housing for inspection of the gear teeth and the bearing.

Replacement of the assembly is recommended if any unusual wear or damage is found.

Housing Assemblies (Left & Right)

Inspect both housing assemblies and bearings for damage. Replacement of complete assemblies will be necessary if any damage is present.

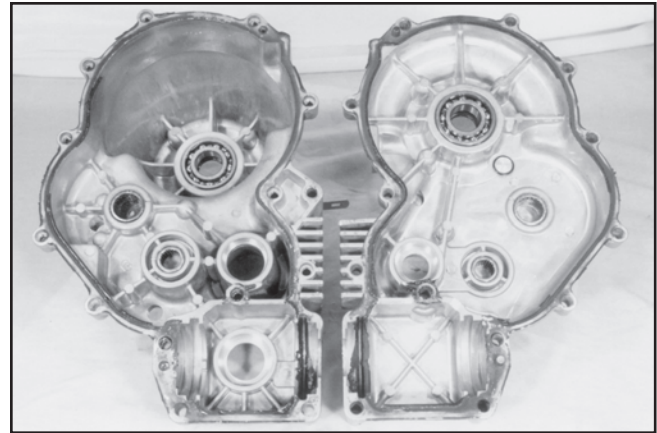

Left and Right Housing Assemblies

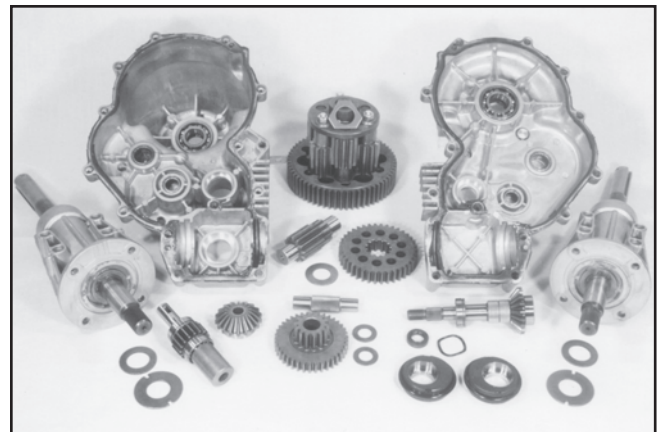

Axle Assembly Components

Reconditioning and Replacement of Parts

After disassembly, all parts should be thoroughly cleaned in a suitable solvent.

All sealant material must be cleaned from the housing halves prior to beginning any reassembly.

Inspect all parts for damage, nicks or unusual wear patterns. Replace all parts having unusual or excessive wear or discoloration.

Inspect the sealing surfaces, bearing surfaces and shaft splines. Polish the sealing areas on the shafts if necessary. Replace any worn or damaged parts.

Clean and lightly lubricate parts prior to assembly.

Replace all o-rings, gaskets and shaft seals.

Be sure to torque all threaded parts to the recommended torque levels.

Assembly Procedures

Install a new lip seal in the left hand housing assembly and install the left hand axle mounting horn assembly onto the left hand housing assembly as described in the minor repairs section. Be sure the orientation of the mounting horn is the same as before it was removed.

Position the left hand housing assembly with the axle mounting horn pointing down.

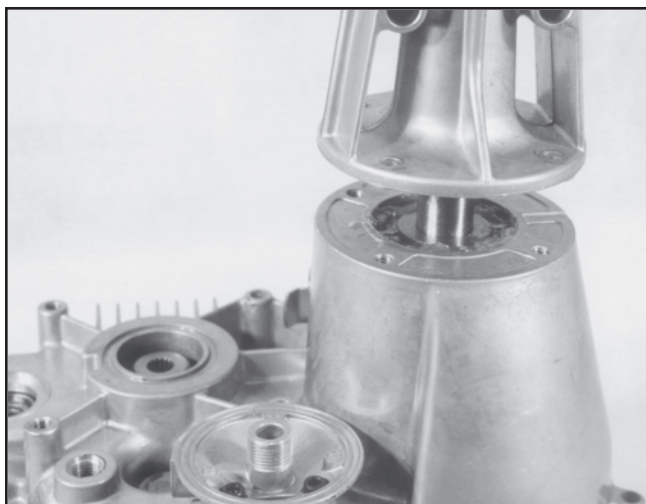

Install Axle Horn

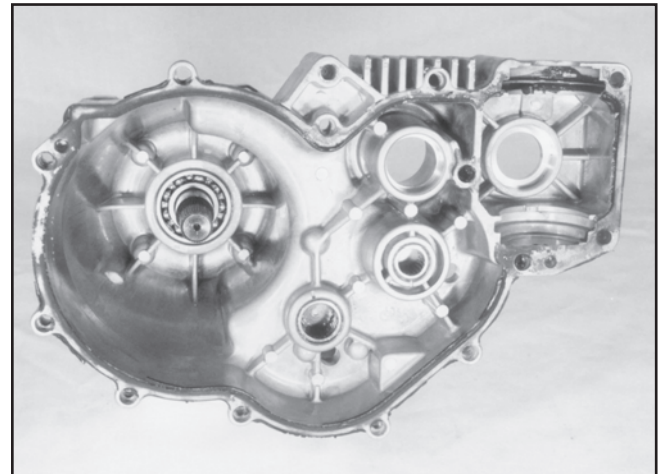

Housing Positioned For Re-assembly

Differential Assembly

Position the triangular washer (tabs pointing up) over the axle end.

Install the differential assembly onto the axle end. The assembly should slide freely into place when the splines are properly aligned.

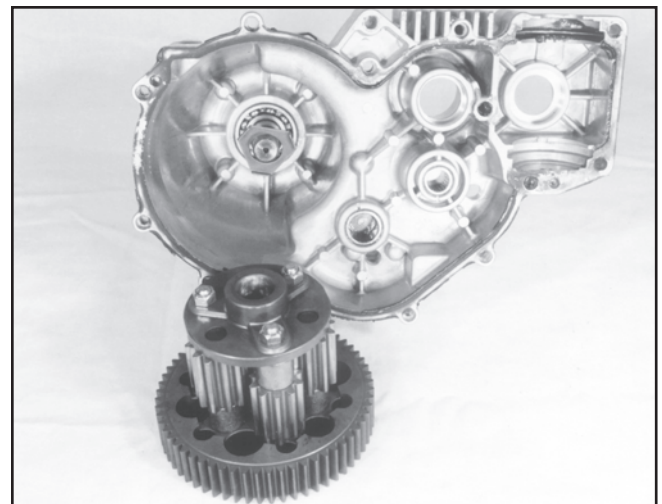

Install Differential Assembly

Reduction Gear/Jack Shaft & Brake Shaft Assembly

Install the brake shaft assembly (coupling end down).

To install the reduction gear/jackshaft it will be necessary to position the reduction gear and one washer (below the reduction gear) then slide the jack shaft through them and into position.

Install the second washer on top of the reduction gear.

210-3000 Assembly Procedures Reduction Gear/Jack Shaft & Brake Shaft Assembly

If the jack shaft does not slide through the reduction gear freely it will be necessary to install them simultaneously with the brake shaft assembly.

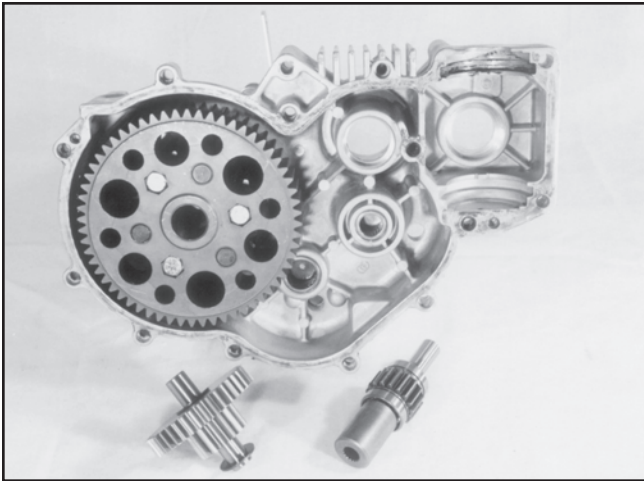

Install Reduction Gear and Brake Shaft Assembly

Final Drive Pinion Assembly

Install the pinion assembly and washer into position (washer on top).

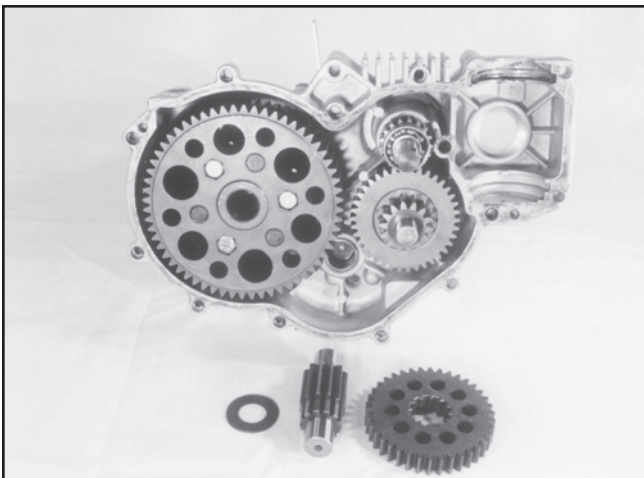

Install Final Drive Pinion

Input Pinion Assembly

Install the input pinion assembly into the housing. The bearing should require very little force to install properly. Make sure the gear and bearing roll freely.

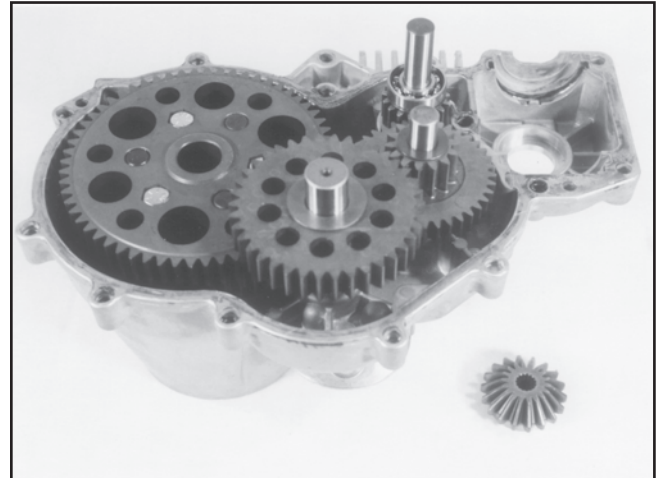

Install Input Pinion

Input Shaft Assembly

NOTE: Prior to assembling of the input shaft components be sure all old gasket material is cleaned from the bearing retainers.

Install a new lip seal into the upper bearing retainer.

Install new o-rings (quad rings) onto each bearing retainer.

NOTE: There have been two styles of bearing retainers used. One style has a machined groove for an o-ring while the other does not have a groove and requires a "quad" ring. Use of the correct ring is necessary to properly seal the assembly.

Wrap the splines and threads of the input shaft with cellophane (or equivalent) to protect the lip seal from damage.

Install the wave washer into the upper bearing retainer and install the bearing retainer onto the input shaft assembly. Remove the cellophane.

Place the input shaft assembly into the lower bearing retainer.

NOTE: The bearing retainers are reversible and interchangeable. Take care to position both so that the input shaft is aligned with the center of the input pinion assembly. Because of the high rpm that these assemblies will run, any misassembly will cause very noisy operation and rapid failure.

Before installing the input shaft assembly, apply a small amount of the liquid gasket sealant in the recessed pocket of the left hand housing where the o-ring on the upper bearing retainer will be positioned.

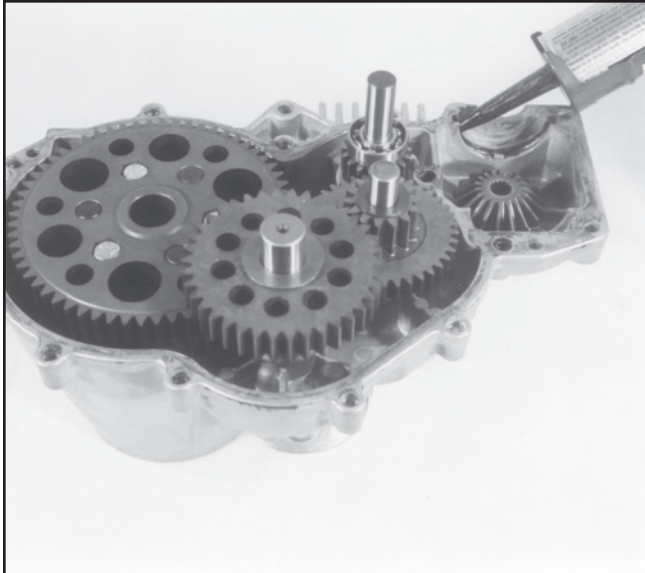

Input Assembly Sealant Application

Apply pressure onto the outer end of each bearing retainer to compress the wave washer and install the complete assembly into the pockets of the housing while aligning the notches in the bearing retainers with the tabs in the housing.

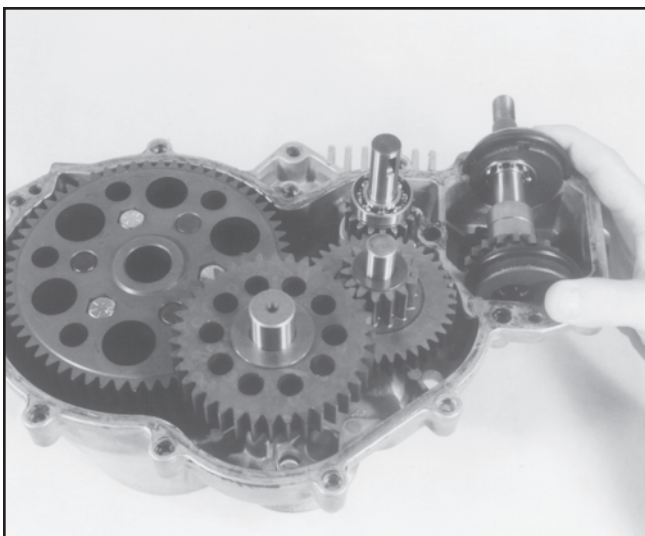

Install Input Assembly

Sealant Application

NOTE: Prior to applying new sealant the old sealant must be cleaned from all surfaces.

Position the right hand housing assembly and apply the liquid gasket onto the housing face. A small bead of the sealant around the outer part of the housing face will be sufficient. The line art indicates the correct areas.

NOTE: A small recess on the right hand housing face is designed to catch a limited amount of sealant as it is squeezed out from between the housings during assembly. This area improves the sealing of the housing but, excessive sealant could contaminate the transaxle assembly. Use sparingly.

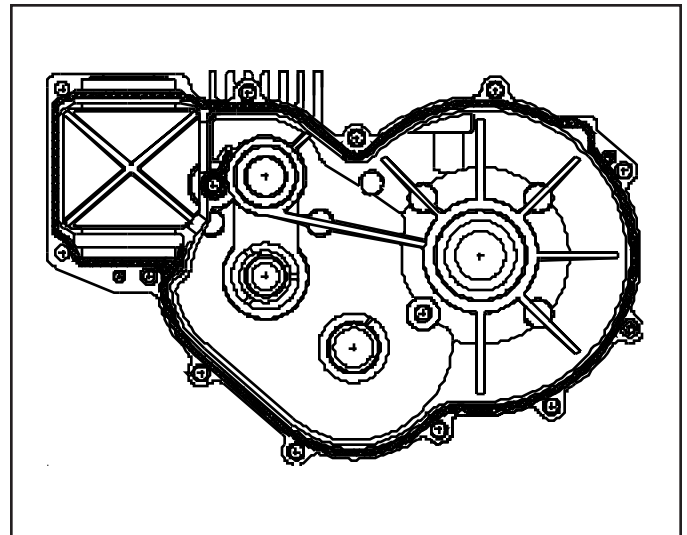

Sealant Application for Models with Input Shaft

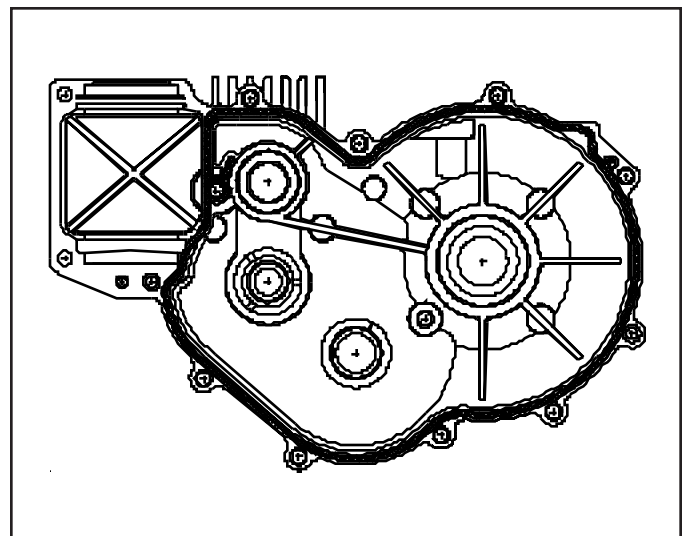

Sealant Application for Models without Input Shaft

210-3000 Assembly Procedures Housing Halves Assembly

With the sealant applied, install the right hand housing down onto the left hand housing while aligning the various shafts with the bearings. Make sure the aligning pins for the housing halves engage properly and seat the right hand housing firmly onto the left.

Apply a locking adhesive and install the eleven primary assembly bolts.

Following the pattern illustrated in the line art, torque each bolt to 16-21 ft.lbs. (21.6-28.5 Nm).

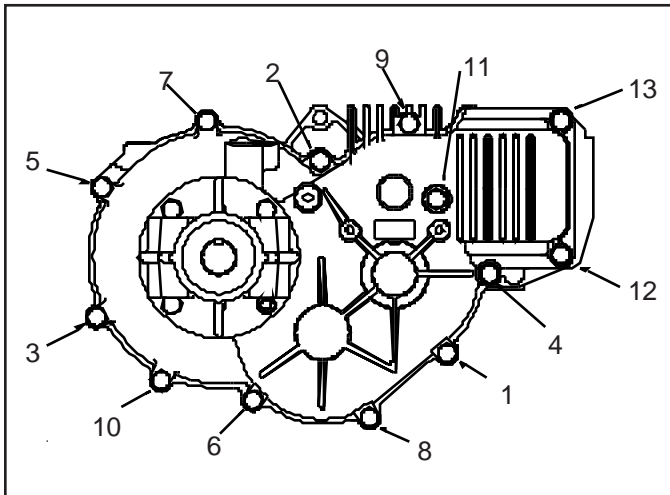

Recommended Bolt Torque Sequence

Install the two "torque strap mounting" bolts and locknuts. Torque each to 13-17 ft.lbs. (17.6-23 Nm).

NOTE: Always use care during assembly procedures to avoid damage to lip seals.

Install a new lip seal into the right hand housing axle bore and install the right hand axle mounting horn assembly as described in the Minor Repairs section.

Install a new lip seal onto the brake shaft as described in the Minor Repairs section.

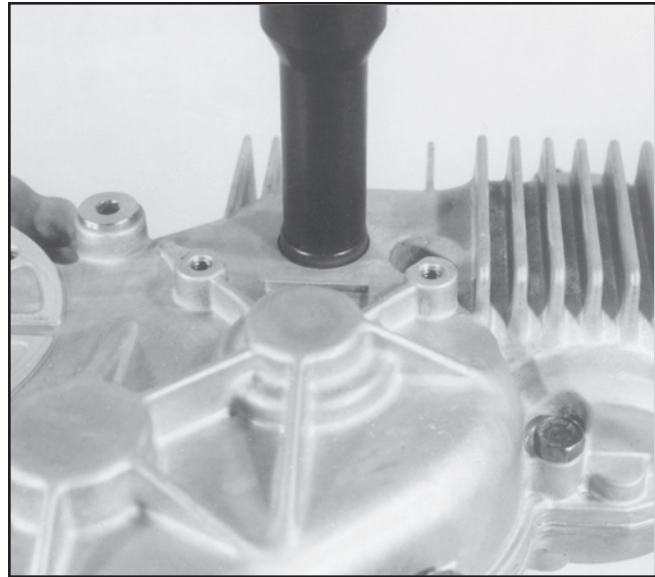

Lip Seal Installation

Roll the gears to insure the proper assembly and function of the unit.

BDU-10L Disassembly Procedures

Prior to performing major repairs on the BDU-10L remove the external components as described in the Minor Repairs section of this manual. These include the following:

- Bypass Valve
- Charge Check Valves
- Charge Pump Assembly

Using a 6mm internal hex wrench, remove the eight screws which retain the center section to the housing.

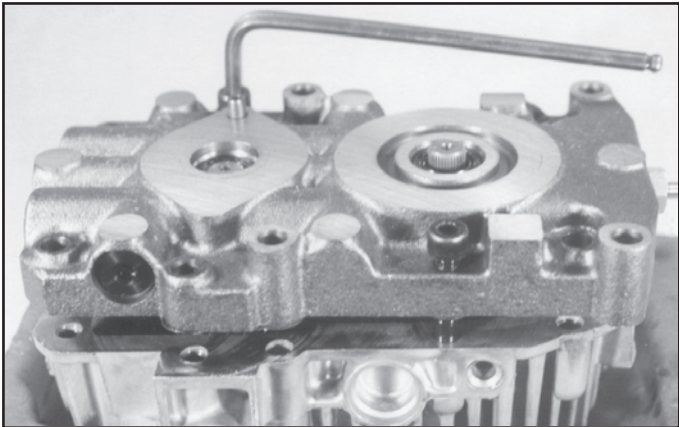

Center Section Removal

The internal springs of the pistons should separate the center section from the housing. Remove the center section from the housing.

CAUTION: The cylinder block may stick to the surface of the center section. Exercise caution to prevent damage to the components.

Remove the gasket and two aligning pins from the housing. The gasket will not be reusable.

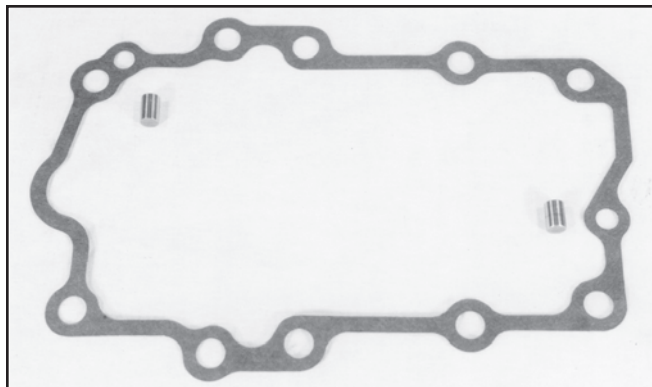

Aligning Pins and Gasket

Remove the pump cylinder block kit from the pump shaft. Inspect the splines on the shaft and in the pump block for damage or excessive wear. Check the pistons and block bores for excessive wear. The pistons should fit with very little side clearance in the block bores, but must slide freely.

Note: The correct bore diameter for the 10cc cylinder block is 0.6295" to 0.6303". The 10cc piston should be 0.6288" to 0.6291" diameter.

Remove the pump cylinder block spring and thrust washer from the pump shaft.

Remove the motor cylinder block kit and shaft assembly from the housing. Check the pistons and block bores for excessive wear. The pistons should fit with very little side clearance in the block bores, but must slide freely. Inspect the splines for damage or unusual wear. Replacement of the complete assembly is recommended if damage or excessive wear is found.

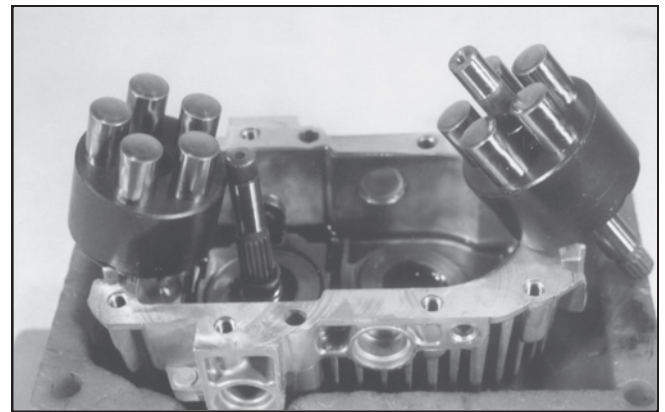

Remove Cylinder Blocks

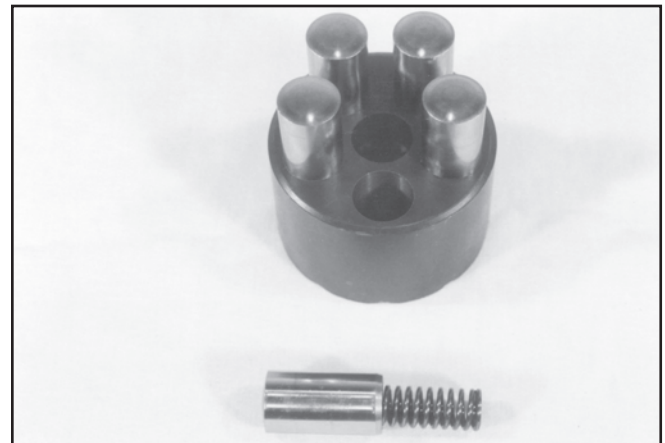

Cylinder Block Components

BDU-10L Disassembly Procedures

Remove the swashplate assembly and cradle bearings from the housing. Inspect the cradle bearings for wear to the low friction coating. Inspect the swashplate and bearing for any unusual wear or damage. If damage to the swashplate or cradle bearings is found, inspect the housing for possible damage. Replace complete assemblies as necessary.

Remove the slot guide block from the displacement control shaft.

Remove the motor thrust bearing from the housing.

Remove the input shaft lip seal retaining ring.

Pull the lip seal out of the housing bore. A hook type tool may be used to pry the seal out. Care must be taken to avoid damage to the housing bore, shaft sealing surface or bearing. Once removed, the seal is not reusable.

Remove the bearing spacer washer.

Remove the pump shaft assembly from the housing.

Inspect the splines on the shaft for damage or unusual wear.

Inspect the bearing. Replacement of the assembly is recommended if any damage or excessive wear is found.

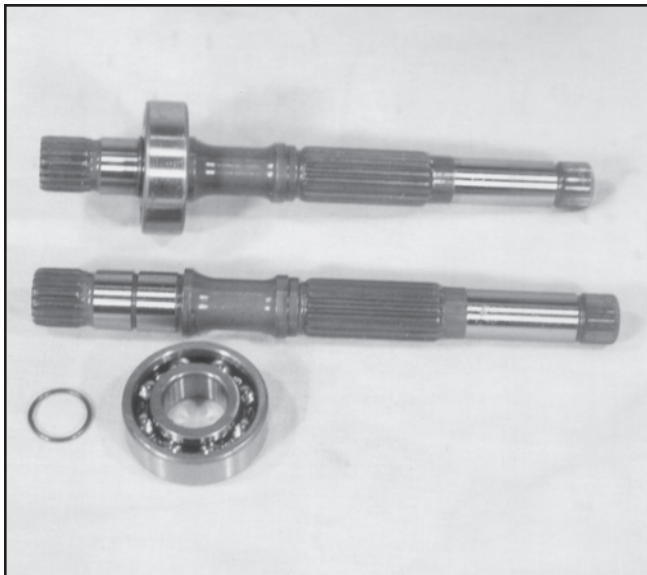
**Pump/Input Shaft Assembly**

Remove the displacement control shaft from the housing.

Remove the displacement control shaft lip seal from the housing. Care must be taken to avoid damage to the housing bore.

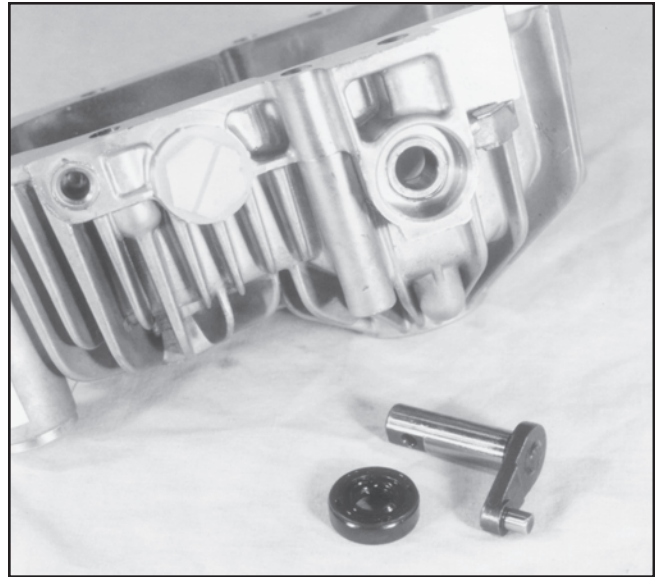
**Housing, Control Arm and Lip Seal**

Inspect the housing for damage.

Inspect the control shaft journal bearing for excessive wear. The bearing should be 0.4722" to 0.4733".

Inspect the housing motor shaft journal bearing for excessive wear. The bearing should be 0.4961" to 0.4998".

If excessive wear or damage was found, replace the complete housing assembly.

Inspect the center section for damage to the cylinder block running surfaces.

Inspect the center section pump shaft journal bearing for excessive wear. The bearing should be 0.4961" to 0.4998".

Inspect the center section motor shaft needle bearing for damage.

If excessive wear or damage was found, replace the complete center section assembly.

Reconditioning and Replacement of Parts

After disassembly, all parts should be thoroughly cleaned in a suitable solvent.

Inspect all parts for damage, nicks or unusual wear patterns. Replace all parts having unusual or excessive wear or discoloration.

Inspect the sealing surfaces, bearing surfaces and shaft splines. Polish the sealing areas on the shafts if necessary. Replace any worn or damaged parts.

The running surfaces of the cylinder blocks MUST be flat and free from scratches. If scratches or wear are found on the running surface of the cylinder block or center section, replace the parts.

BDU-10L Assembly Procedures

Clean and lightly oil parts prior to assembly of the BDU-10L transmission.

Be sure to torque all threaded parts to the recommended torque levels.

Replace all o-rings, gaskets and shaft seals.

CAUTION: Most parts have critical high tolerance surfaces. Care must be exercised to prevent damage to these surfaces during assembly. Protect all exposed surfaces, openings and ports from damage or foreign material.

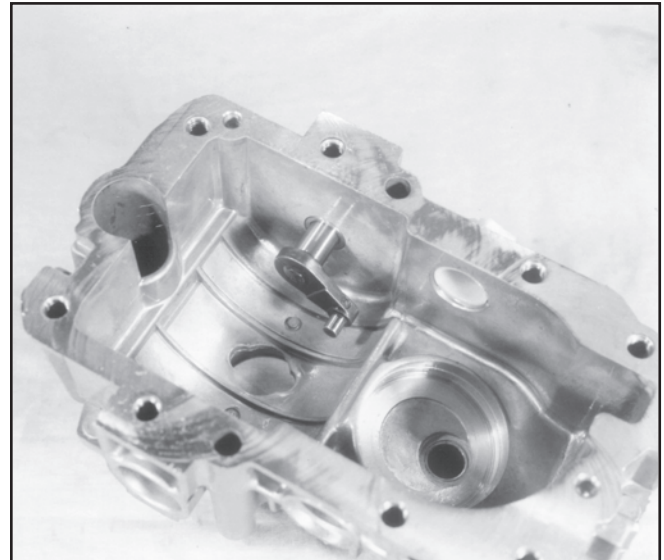

Control Arm Installation

Install the displacement control shaft.

Install the pump shaft assembly into the housing.

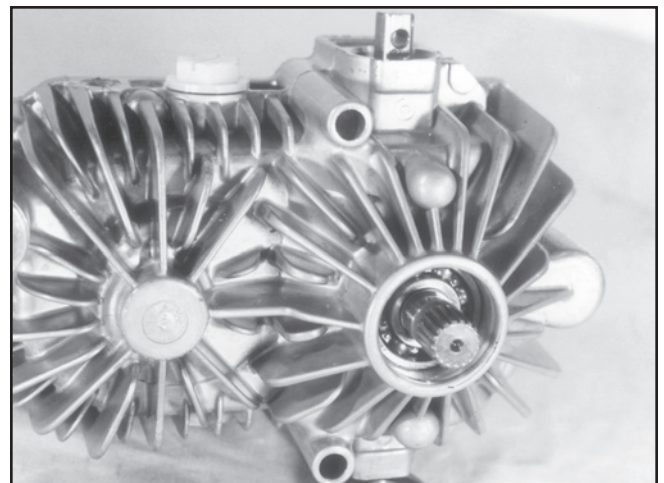

Shaft Installation

BDU-10L Assembly Procedures

Install the bearing spacer washer.

Install the lip seal and retaining ring as described in the Minor Repair section.

Install the cradle bearings.

Install the slot guide block onto the displacement control shaft.

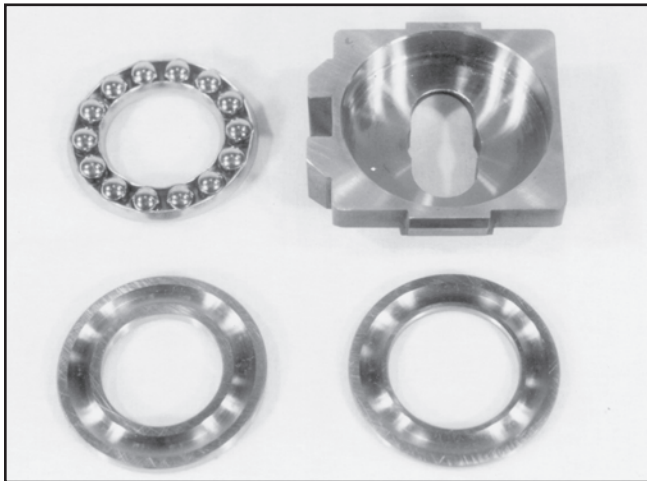

Swashplate Kit Components

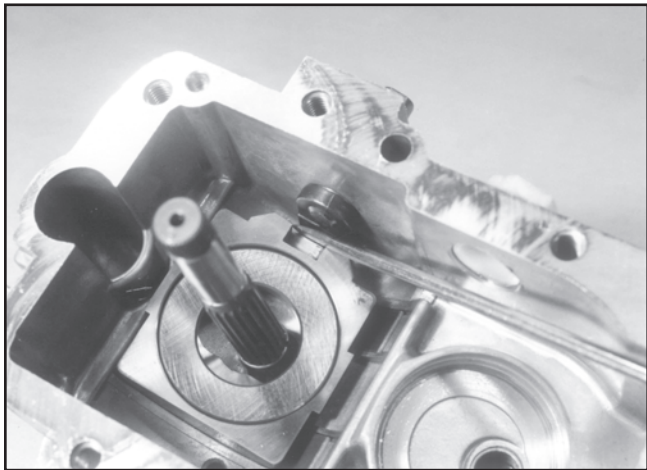

Install Swashplate

Install the swashplate into the housing. The slot on the swashplate must engage the slot guide block on the displacement control shaft. Use a tool such as a screwdriver or scribe to hold the guide block in position while installing the swashplate.

Hold the swashplate in position and measure the end play of the displacement control shaft using a dial indicator or a depth gauge. Using a suitable sleeve, press the control shaft bearing into the housing until the control shaft end play is between 0.020" and 0.060" (.508-1.5 mm).

Install the thrust washer and pump cylinder block spring onto the pump shaft.

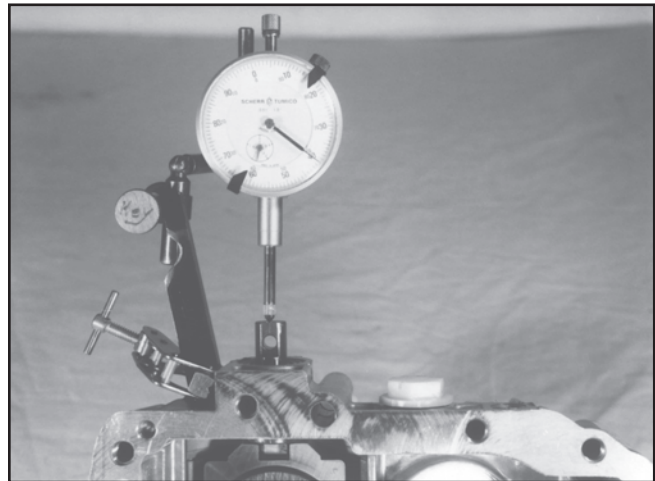

Measure Control Arm End Play

Install the springs, piston washers and pistons into the cylinder block. The pistons must move freely in their bores.

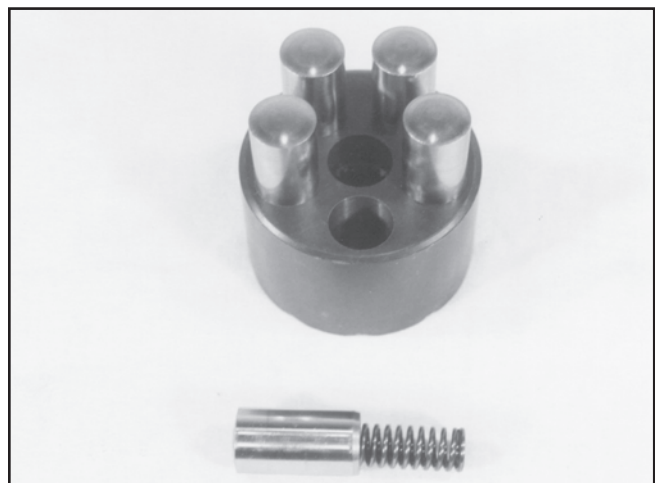

Cylinder Block Kit

NOTE: To simplify the installation of both the motor block and the pump block kits, wrap a rubber band snugly around the pistons. This is intended to hold the pistons in their bores as the block kits are handled during installation.

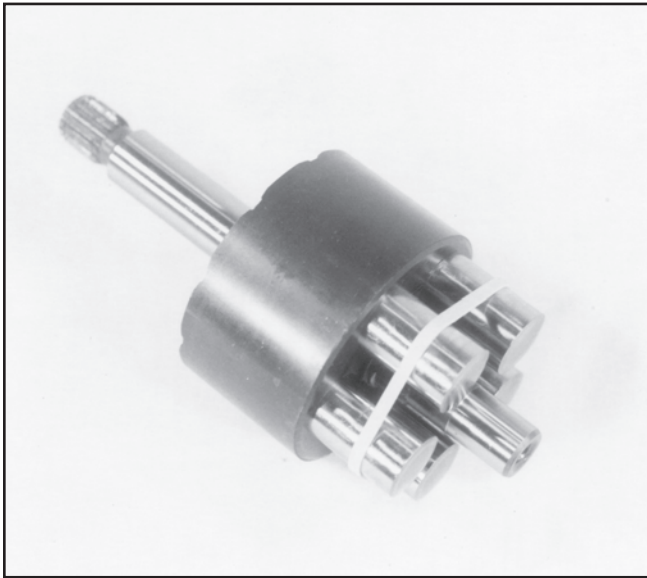

Cylinder Block Kit with Rubber Band

With the swashplate in the “neutral” (0 angle) position and the transmission housing laying on its side, install the pump cylinder block kit onto the pump shaft in the housing.

Install the motor thrust bearing into the housing.

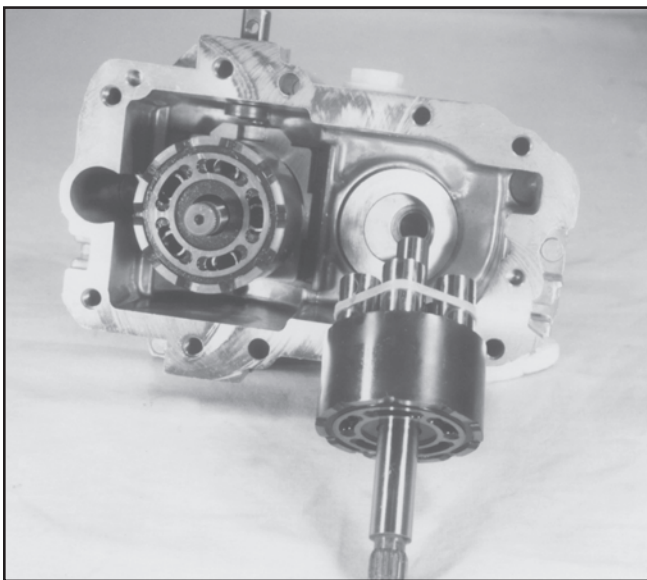

Install Motor Shaft Kit

NOTE: It will be necessary to have a **Dry** journal bearing to prevent a hydraulic lock while installing the motor shaft kit.

Install the motor shaft/cylinder block kit. Use caution to prevent damage to the journal bearing while guiding the shaft into position. Once installed, it will be necessary to hold the assembly in position until the center section has been installed.

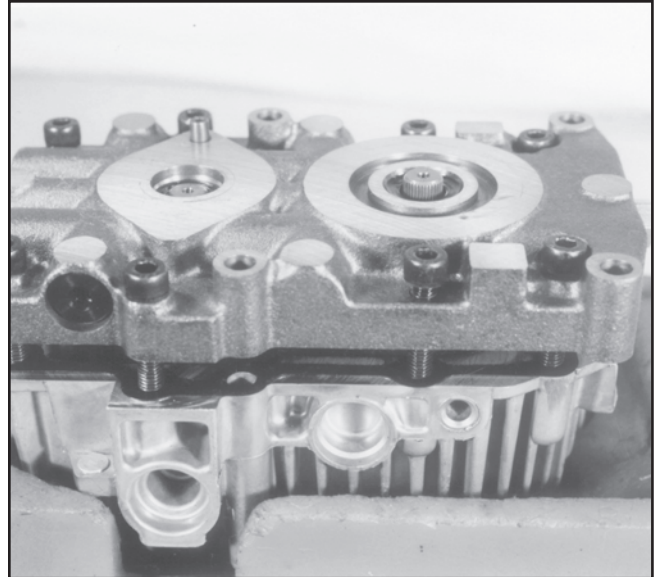

Install Center Section

Check to see that the piston springs are centered in the cylinder block bores. If necessary, position them with a small screwdriver.

Position the housing with the housing opening UP, and install the two aligning pins and new gasket onto the housing.

Lubricate the running surfaces of the cylinder blocks and the center section.

Install the center section onto the housing. While holding the motor shaft in position in the housing journal bearing.

CAUTION: Make sure all parts are properly aligned. Do not use excessive force.

Install the eight bolts and torque evenly to 12-15 ft.lbs. (16-20 Nm).

Rotate the shafts a minimum of two turns to assure correct assembly. When properly assembled the shafts should require minimal torque to turn, approximately 15 in.lbs. (1.7 Nm).

Refer to the Minor Repair section of this manual to complete reassembly of the BDU transmission.

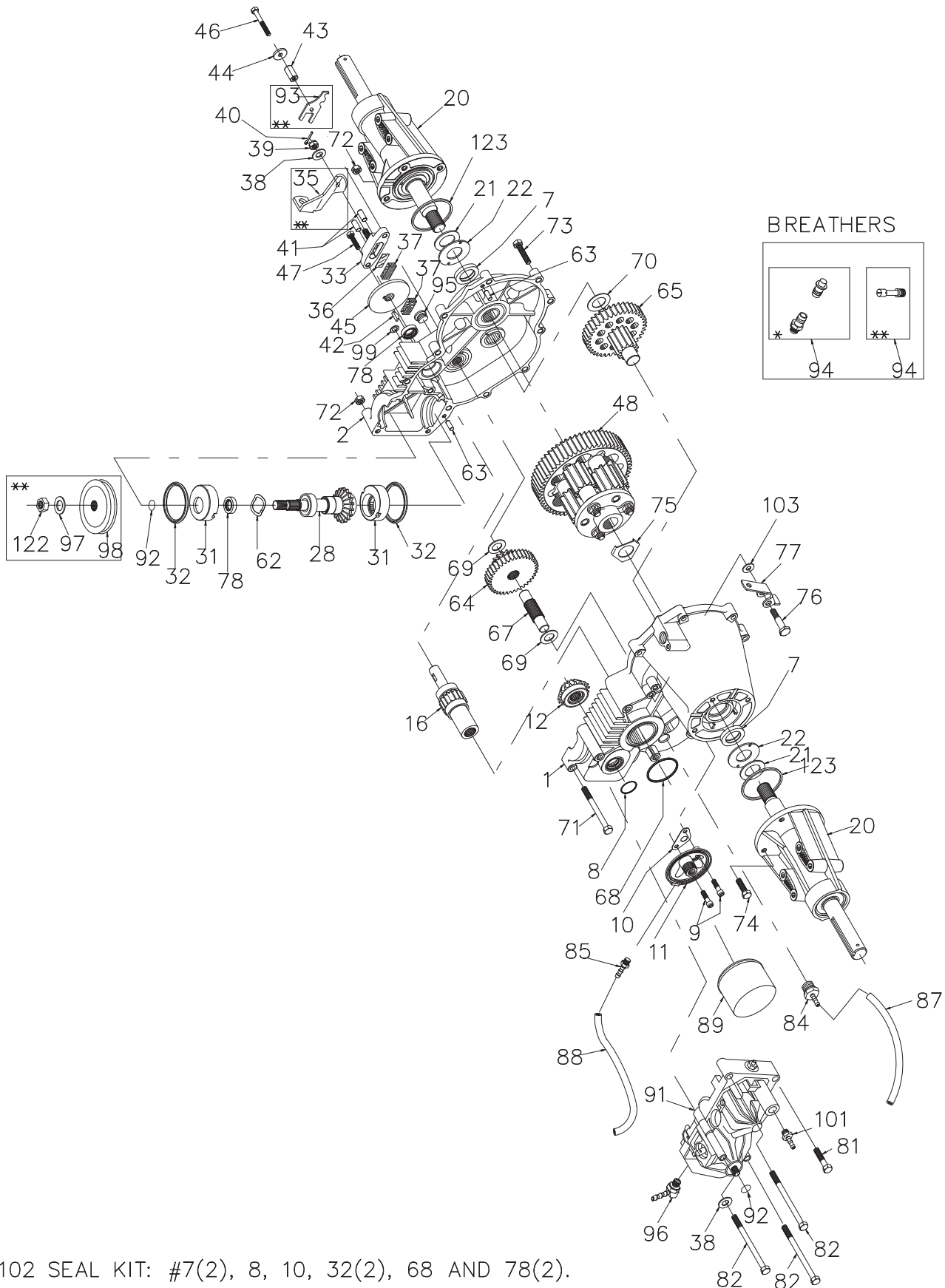

102 SEAL KIT: #7(2), 8, 10, 32(2), 68 AND 78(2).

PARTS LIST

| NO. | DESCRIPTION | NO. | DESCRIPTION |
|-----|------------------------------|-----|------------------------------------|
| 1 | LH HSG ASSEMBLY | 70 | WASHER, 7/8 ID X 1-1/2 OD |
| 2 | RH HSG ASSEMBLY | 71 | HEX BOLT, 5/16-18 X 3-1/2 |
| 7 | OIL SEAL, .984 X 1.5 X .25 | 72 | HEX LOCK NUT 5/16-18 |
| 8 | QUAD RING | 73 | HEX BOLT, 5/16-18 X 1-1/2 |
| 9 | CAP SCREW, 1/4-20 X 1 | 74 | HEX BOLT 5/16-18 X 1 |
| 10 | GASKET, FILTER BASE | 75 | DIFFERENTIAL WASHER |
| 11 | FILTER BASE ASSEMBLY | 76 | SHOULDER BOLT |
| 12 | PINION ASSEMBLY | 77 | FREEWHEEL ACTUATING ARM, |
| 16 | BRAKE SHAFT ASSEMBLY | 78 | OIL SEAL .625 X 1.0 X .25 |
| 20 | AXLE MOUNTING HORN ASSEMBLY | 81 | HEX BOLT 5/16-18 X 1-3/4 |
| 21 | WASHER, 1.0 X 1.63 X .08 | 82 | HEX BOLT 5/16-18 X 4-1/2 |
| 22 | WASHER, 1.0 X 2.06 X .09 | 84 | SAE PORT STRAIGHT FITTING 7/8 |
| 28 | INPUT ASSEMBLY | 85 | SAE PORT STRAIGHT FITTING 7/16 |
| 31 | BEARING RETAINER | 87 | HOSE, 8-1/2" LONG |
| 32 | O RING, 2-1/2 OD | 88 | HOSE, 10-1/2" LONG |
| 33 | ASSEMBLY, BRAKE YOKE | 89 | SPIN-ON FILTER |
| 35 | ARM, BRAKE | 91 | TRANSMISSION |
| 36 | PLATE, PUCK | 92 | WIRE RETAINING RING |
| 37 | PUCK, BRAKE | 93 | BRACKET |
| 38 | WASHER, 7/16 X 7/8 OD X .060 | 94 | BREATHER |
| 39 | NUT, CASTLE 5/16-24 | 95 | PLUG, STRAIGHT THREAD |
| 40 | COTTER PIN | 96 | FITTING |
| 41 | BRAKE ACTUATING PIN | 97 | WASHER |
| 42 | HIPRO KEY, 3/16 X 5/8 | 98 | PULLEY |
| 43 | TORSION SPRING SPACER | 99 | WASHER, 5/16 ID X 9/16 OD |
| 44 | WASHER, 7/8 OD X .260 ID | 101 | STRAIGHT SE A 7/8 FITTING |
| 45 | DISC, BRAKE | 102 | SEAL KIT |
| 46 | BOLT, 1/4-20 X 2 | 103 | WASHER |
| | BOLT, 1/4-20 X 1-1/2 | 108 | CONTROL ARM |
| 47 | BOLT, 1/4-20 X 1 | 109 | SET SCREW |
| 48 | DIFFERENTIAL ASSEMBLY | 110 | FILTER HEAD |
| 62 | WAVE WASHER | 111 | HOSE, 5/16 DIA. X 12" LONG |
| 63 | DOWEL PIN | 113 | 90°-7/8 SAE FITTING |
| 64 | 14T-38T REDUCTION GEAR | 116 | 45°-9/16 SAE FITTING |
| 65 | FINAL DRIVE PINION ASSEMBLY | 117 | 90°-9/16 SAE FITTING |
| 67 | JACK SHAFT | 118 | 90°-SAE #6 FLARE MALE FITTING |
| 68 | O-RING | 119 | STRAIGHT 5/16 FLARE FEMALE FITTING |
| 69 | WASHER, 5/8 ID X 1-5/32 OD | 122 | 9/16 HEX JAM NUT |

BDU-10L

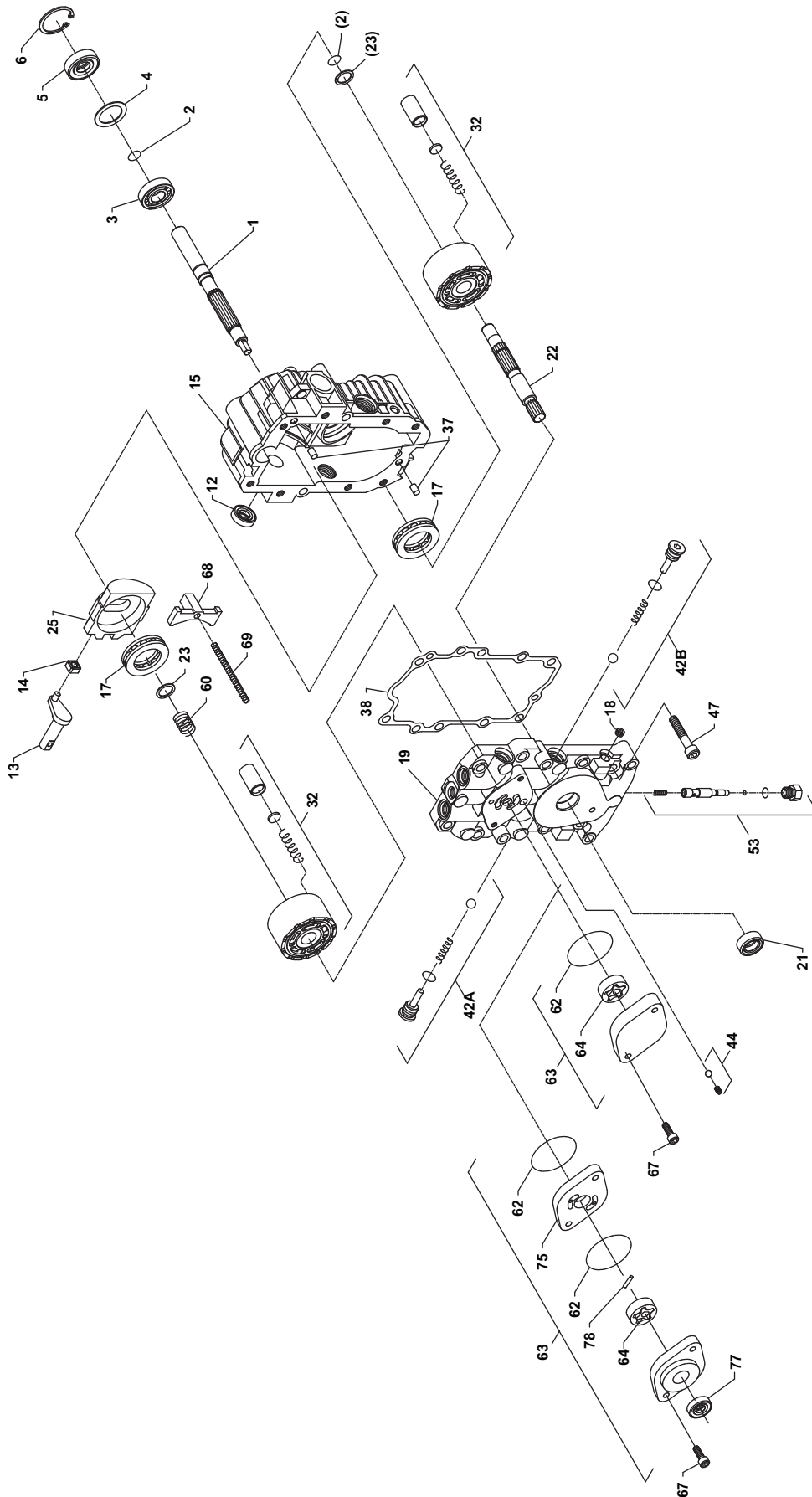

79 SEAL KIT

PARTS LIST

| NO. | DESCRIPTION | NO. | DESCRIPTION |
|------------|-----------------------------|------------|------------------------------|
| 1 | PUMP SHAFT | 37 | PIN ST HDLS |
| 2 | WIRE RETAINING RING | 38 | CENTER SECTION GASKET |
| 3 | SHAFT BALL BEARNG | 42 | CHECK VALVE KIT |
| 4 | SPACER | 44 | CHARGE RELIEF KIT |
| 5 | LIP SEAL | 47 | SOCKET HEAD CAP SCREW |
| 6 | RETAINNG RING | 53 | BYPASS VALVE KIT |
| 12 | LIP SEAL | 60 | BLOCK SPRING |
| 13 | TRUNNION ARM | 62 | O-RING |
| 14 | SLOT GUIDE | 63 | CHARGE PUMP KIT |
| 15 | HOUSING KIT | 64 | GEROTOR ASSEMBLY |
| 17 | THRUST BALL BEARNG ASSEMBLY | 67 | CAP SCREW |
| 18 | PLUG, PIPE | 68 | LEVELER |
| 19 | CENTER SECTION ASSEMBLY | 69 | SPRING - HELICAL COMPRESSION |
| 21 | LIP SEAL | 75 | SPACER PLATE |
| 22 | MOTOR SHAFT | 77 | SEAL-LIP |
| 23 | BLOCK THRUST WASHER | 78 | PIN-NEEDLE DOWEL |
| 25 | VARIABLE SWASHPLATE | 79 | SEAL KIT |
| 32 | BLOCK ASSEMBLY | | |



© 2009 HYDRO-GEAR
Printed in U.S.A.
Rev. P3

