

PHILIPS

DreamStation Go

Heated Humidifier

User manual



Instructions for use

Table of contents

| | |
|---|-----------|
| 1. Safety information | 1 |
| 2. System overview | 3 |
| 3. Connecting and setting up the humidifier | 5 |
| Humidifier pop-up messages | 7 |
| 4. Daily use | 8 |
| 5. Cleaning | 11 |
| Cleaning the water tank base | 11 |
| Cleaning the water tank lid and components | 11 |
| 6. Maintenance instructions | 13 |
| Maintaining the water tank base | 13 |
| Maintaining the humidifier base | 13 |
| 7. Troubleshooting | 14 |
| 8. Additional notes | 16 |
| 9. DreamStation Go Heated Humidifier specifications | 17 |
| Environmental | 17 |
| Physical | 17 |
| Service life | 17 |
| Standards compliance | 17 |
| IEC 60601-1 classification | 18 |
| Electrical (when the heated humidifier is used with the DreamStation Go therapy device) | 18 |
| Maximum recommended pressure | 18 |
| Water capacity | 18 |
| Heater plate | 18 |
| Inhalation ressure drop of humidifier | 18 |
| Exhalation ressure drop of humidifier | 18 |
| Humidity | 18 |
| Maximum delivered gas temperature | 18 |
| Declared dual-number noise emissions values | 19 |
| Pressure accuracy | 19 |
| Maximum flow rate | 19 |
| Limited Warranty | 21 |

1. Safety information

Intended use

The DreamStation Go Heated Humidifier is an accessory for the Philips Respironics DreamStation Go therapy devices to provide moisture to the patient circuit. It is intended for use in spontaneously breathing patients weighing over 30 kg (66 lbs), in the home or hospital/institutional environment, who use mask-applied positive pressure ventilation therapy.



Warnings

A warning indicates the possibility for injury to the user or the operator.

- Use the humidifier only for its intended use as described in this manual. Use only with masks and connectors recommended by Philips Respironics.
- Periodically inspect the humidifier for signs of wear or damage. Never operate the humidifier if any parts are damaged, if it is not working properly, or if the humidifier has been dropped or mishandled. Do not use the humidifier if the water tank is leaking or damaged in any way. Have any damaged parts replaced before continuing use.
- Periodically inspect the therapy device power cord for signs of wear or damage. If it becomes worn or damaged, contact Philips Respironics or your supplier for a replacement.
- The humidifier must always be positioned below the breathing circuit connection at the mask. The humidifier must be level for proper operation.
- Allow the humidifier heater plate and water to cool down for approximately 15 minutes before removing the water tank. A burn may result from: touching the heater plate, coming in contact with the heated water, or touching the tank pan.
- This equipment is not suitable for use in the presence of a flammable anesthetic mixture with air or with oxygen or nitrous oxide.
- When installing the water tank, do not allow any water to spill into the humidifier or therapy device.
- If you notice any unexplained changes in the performance of this device, if it is making unusual or harsh sounds, if it has been dropped or mishandled, or if the enclosure is broken, disconnect the power cord from the therapy device and discontinue use. Contact your supplier.
- Before cleaning the humidifier, always remove from the therapy device.
- Empty and clean the water tank daily to prevent mold and bacteria growth.
- Repairs and adjustments must be performed by Philips Respironics-authorized service personnel only. Unauthorized service could cause injury, invalidate the warranty, or result in costly damage.
- Do not use any accessories, detachable parts, and materials not recommended by Philips Respironics. Incompatible parts or accessories can result in degraded performance.

Note: Please see the *Limited warranty* section of this manual for information on warranty coverage.

Cautions

A caution indicates the possibility of damage to the device.

- U.S. federal law restricts this device to sale by or on the order of a physician.
- Do not place the humidifier directly onto carpet, fabric, or other flammable materials.
- Do not place the device in or on any container that can collect or hold water. Take precautions to protect furniture from water damage.
- Do not fill the water tank above the maximum fill line. If the water tank is overfilled, water may leak into the therapy device, humidifier, or onto your furniture. Damage to the humidifier or therapy device may occur.
- Philips Respironics recommends using room temperature distilled water, if available, to prevent mineral build up on the humidifier tank base.
- Never use water from a biologically unsafe source such as a lake, river, stream, or well.
- Do not put any chemicals or additives into the water. Possible airway irritation or damage to the water tank may result.
- Remove the tank, empty all water, and replace the empty tank before transporting the humidifier base.
- Do not attempt to fill the water tank while it is still inside the humidifier.
- To avoid spilling, do not disconnect the humidifier from the therapy device with water in the tank. Remove the water tank from the humidifier before disconnecting the therapy device.
- Do not turn the humidifier on without the water tank installed. The Humidifier setting must be “0” (off) if there is no water in the water tank.
- Do not move the humidifier while the water tank has water in it.
- Use a mild liquid dishwashing detergent only for either hand washing or when using a dishwasher.
- Only the hospital and institution cleaning procedures listed in this manual are recommended by Philips Respironics. Use of other cleaning and disinfecting processes, not specified by Philips Respironics, may affect the performance of the product.

Note

The DreamStation Go Heated Humidifier is specified for use with Philips Respironics DreamStation Go therapy devices only.

Important

Read and understand the entire manual for your therapy device before attempting to use this humidifier.

Contraindications

Studies have shown that the following pre-existing conditions may contraindicate the use of CPAP therapy for some patients:











- Bullous Lung Disease
- Pathologically Low Blood Pressure
- Bypassed Upper Airway
- Pneumothorax
- Pneumocephalus has been reported in a patient using nasal Continuous Positive Airway Pressure. Caution should be used when prescribing CPAP for susceptible patients such as those with: cerebral spinal fluid (CSF) leaks, abnormalities of the cribriform plate, prior history of head trauma, and/or pneumocephalus. (Chest 1989; 96:1425-1426)

The use of positive airway pressure therapy may be temporarily contraindicated if you exhibit signs of a sinus or middle ear infection. Not for use with patients whose upper airways are bypassed. Contact your health care professional if you have any questions concerning your therapy.

Refer to the instructions for use that accompanied your therapy device for any additional contraindications that may be specific to the use of that device.

Symbols Glossary

The following symbols may appear on the device. Refer to <http://www.symbols.philips.com> for a description of additional symbols used on this device and its packaging.

| Symbol | Definition | Symbol | Definition |
|---|--|---|--|
|  | Maximum fill line |  | Drip Proof Equipment Protection against ingress of solid foreign objects \geq 12.5 mm diameter. Protection against ingress of water with harmful effects dripping (15° tilted) |
|  | Warning: Hot surface |  | Reorder number Indicated the manufacturer's catalogue number so the medical device can be identified. |
|  | Date of manufacture Indicates the date when the medical device was manufactured. |  | Serial number Identify the manufacturer's serial number for the medical device. |
|  | Manufacturer Indicates the medical device manufacturer. |  | Operator's manual; operating instructions Consult instructions for use. |
|  | Type BF applied part To identify a type BF applied part complying with IEC 60601-1. |  | Prescription device Caution: U. S. federal law restricts this device to sale by or on the order of a physician. |

How to contact Philips Respironics

Should you experience trouble with this equipment or require assistance setting up, using, or maintaining the device or accessories, please contact your supplier. If you need to contact Philips Respironics directly, call the Philips Respironics Customer Service department at 1-800-345-6443 or 1-724-387-4000. You can also use the following address:

Respironics, Inc.
1001 Murry Ridge Lane
Murrysville, PA 15668

2. System overview

The DreamStation Go Heated Humidifier attaches to the therapy device and provides an air outlet port to connect a breathing circuit. The breathing circuit is composed of patient tubing, a mask, and in some instances a separate exhalation device. The patient tubing is 12 mm performance tubing. For information related to the mask to be used, including any need for a separate exhalation device, consult the instructions for use that accompany both the mask and therapy device.

Note

The DreamStation Go Heated Humidifier is not supported for use with battery power. Only connect the CPAP and Humidifier together to receive therapy.

The DreamStation Go Heated Humidifier is designed to deliver humidification for added comfort during therapy. This humidification level is controlled through the output of the heated humidifier.

The DreamStation Go Heated Humidifier is composed of the following components:

- **Heated humidifier** – The heated humidifier is the primary source of humidification. Humidification is controlled by adjusting the temperature of the heater plate. The heater plate is then used to heat water found in the water tank. This manual includes instructions that explain how to set up and take care of the heated humidifier.
- **Water tank** – The water tank stores the water that will be used by the heated humidifier. This manual includes instructions that cover how to use and take care of the water tank.

System features and contents

The figure below illustrates many of the device features and contents. In addition to the features shown below, your humidifier system may include a humidifier user manual.

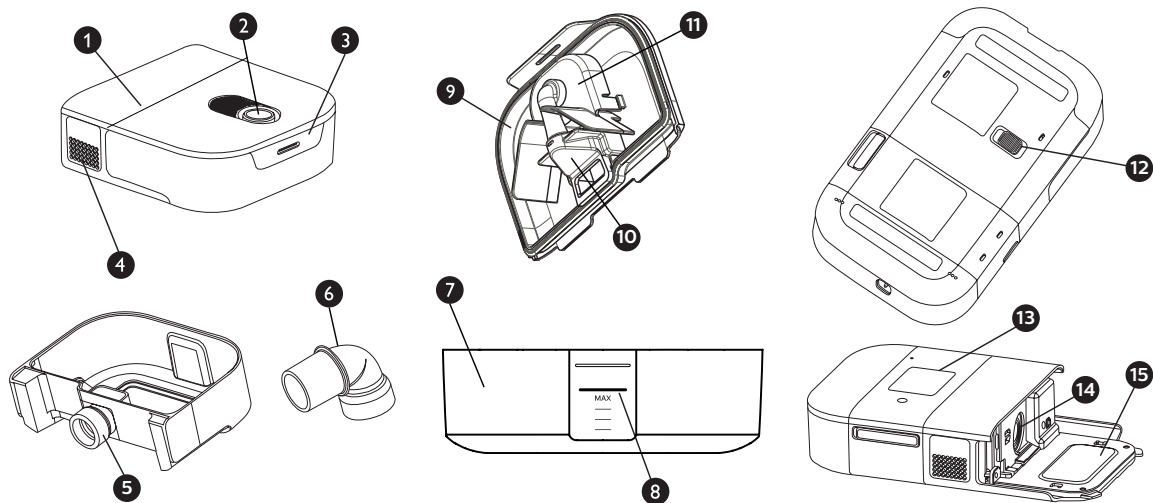

| | | | |
|---|------------------------|----|--------------------------|
| 1 | Heated humidifier | 9 | Water tank lid |
| 2 | Air outlet port | 10 | Manifold |
| 3 | Water tank lid tab | 11 | Baffle |
| 4 | CPAP air inlet | 12 | Humidifier release latch |
| 5 | CPAP Seal | 13 | Therapy device |
| 6 | 15mm/22mm tube adapter | 14 | Humidifier air inlet |
| 7 | Water tank base | 15 | Heater plate |
| 8 | Maximum fill line | | |

3. Connecting and setting up the humidifier

Connecting to the therapy device

1. Remove the humidifier beauty panel from the therapy device by pulling from either side of the panel.

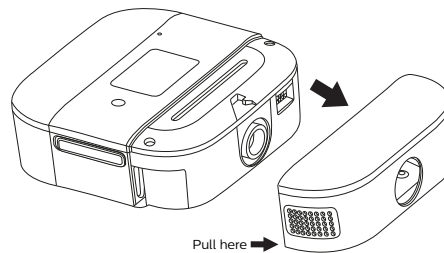

2. Place the therapy device and heated humidifier (with an empty water tank) on a firm, flat surface.
3. Line up the front of the therapy device to the front of the humidifier. Make sure the air outlet port on the therapy device lines up with the air inlet port on the humidifier.
4. Slide the therapy device and humidifier together until they snap into place.

Caution

Do not move the humidifier while the water tank has water in it.

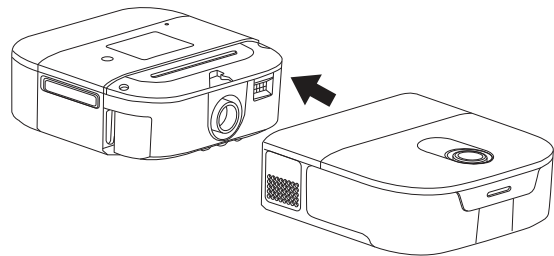

5. Make sure that the therapy device and the humidifier are completely connected to each other.

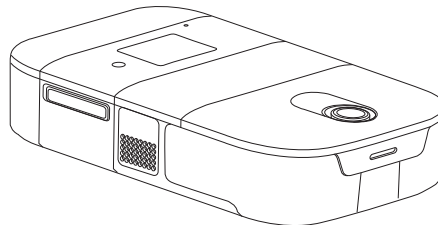

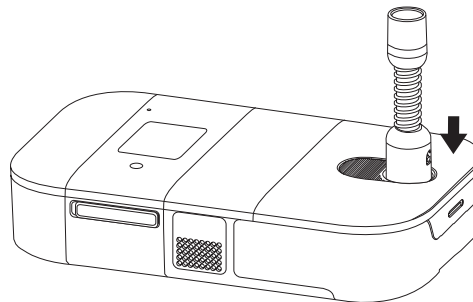

6. Attach the tube to the heated humidifier. Line up the connector at the top of the tube to the top of the air outlet port on the humidifier after filling the humidifier. Refer to the "Daily use" section. If you are not using a 12mm tube, use the 15mm/22mm tube adapter.
7. Press the tubing connector into place over the air outlet port until the tube clicks into place in the slots on the sides of the outlet port.



Setting humidification mode and target time

To access the humidifier settings in the **Therapy Off** menu, navigate to the **My Comfort** menu. From here you can view or adjust the following humidifier settings.

| Icon | Text | Description |
|---|----------------|--|
|  | Humidification | This displays the humidification mode being used. You can choose between Fixed or Adaptive humidification. |
|  | Target Time | <p>This allows you to set the estimated amount of time you will use the device each night. The device will then adjust the humidification to ensure enough water remains in the water tank. You can select Off, Auto, or 4 to 10 hours in 0.5 hour increments. This setting is only available when the humidifier is set to Adaptive humidification mode.</p> <p>When set to Auto, the device automatically sets the target time based on your past device usage hours.</p> <p>Note Many factors impact water consumption, including: the ambient temperature and humidity in your bedroom, your humidifier settings, the level of mask leak, and the duration of your sleep session.</p> |

Adjusting the humidifier setting from the “Therapy On” menu

While the device is delivering therapy with the humidifier attached, you can adjust the humidifier setting by following the steps below.

1. Tap the humidifier icon on the bottom left of the touchscreen.



2. Tap the left arrow or swipe left on the touchscreen to decrease the humidifier setting. Tap the right arrow or swipe right on the touchscreen to increase the humidifier setting. The setting can be adjusted from 0 to 5. When the setting is 0 the humidifier is turned off.

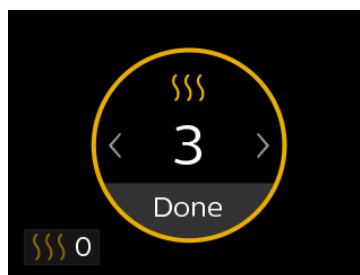

3. Tap Done to save and apply the new humidifier setting.

Humidifier pop-up messages

Device pop-ups are messages that show up on the user interface screen.

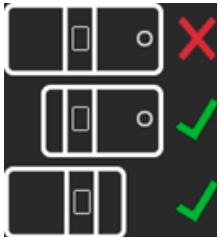
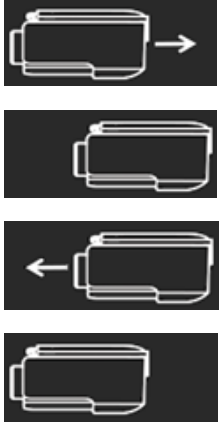
| Condition | Icon | Description | Possible Cause | Action |
|--|--|---|---|--|
| Humidification Error |  | Humidifier error (only when humidifier is present). | Humidifier heater plate error or humidifier not properly connected to therapy device. | Turn off the device and disconnect it from power. Detach the humidifier, visually check that electrical contacts are clear, then reconnect humidifier and power cord. If the alert continues, contact your supplier. |
| Humidifier and Battery Unsupported |  | Therapy is not available when both the battery and humidifier are connected to the CPAP device. | Therapy was started when both the battery and humidifier were connected. | Remove the battery to enable therapy with humidification. |
| Humidifier Water Tank Inserted Incorrectly |  | Displayed when the humidifier water tank is not inserted correctly. | The humidifier water tank is not making contact with the heater plate. | Tap to clear the error. Disconnect and reconnect the humidifier water tank to make sure that it is fully and properly connected. |

4. Daily use

Warning

Allow the humidifier heater plate and water to cool down for approximately 15 minutes before removing the water tank. A burn may result from: touching the heater plate, coming in contact with the heated water, or touching the tank pan.

Cautions

- Do not attempt to fill the water tank while it is still inside the humidifier.
- Do not put any chemicals or additives into the water. Possible airway irritation or damage to the water tank may result.
- Philips Respironics recommends using room temperature distilled water, if available, to prevent mineral build up on the humidifier tank base. In a clinical environment, distilled water must be used.
- Never use water from an untreated source such as a lake, river, stream, or well.
- Do not fill the water tank above the maximum fill line. If the water tank is overfilled, water may leak into the therapy device, humidifier, or onto your furniture. Damage to the humidifier or therapy device may occur.

Notes

- Clean the water tank before first use. Refer to the Home cleaning instructions and Care instructions sections later in this manual.
- Empty, rinse, and refill the water tank daily.

1. Place the connected therapy device with humidifier on a firm, flat surface lower than your sleeping position.

Warning

The humidifier must always be positioned below the breathing circuit connection at the mask. The humidifier must be level for proper operation.

Cautions

- Do not place the humidifier directly onto carpet, fabric, or other flammable materials.
- Do not place the device in or on any container that can collect or hold water. Take precautions to protect furniture from water damage.

2. Disconnect the tubing by pulling the tubing connector away from the outlet port.

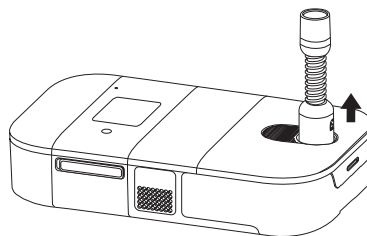

3. Remove the water tank by sliding the tank away from the therapy device.

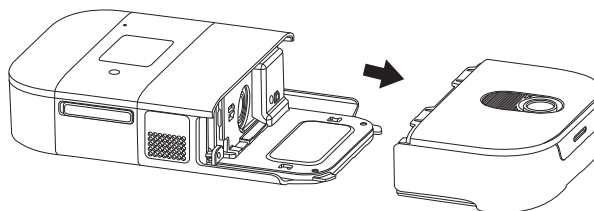

- Remove the tank lid by pulling up on the tank lid tab while holding the tank base. Pour out any remaining water and rinse the tank base.

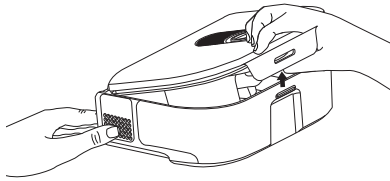

- Place the tank base on a firm, flat surface. Fill the tank base with water no higher than the maximum fill line **MAX**.

Note

The water level may rise in the tank base when the tank lid is attached.

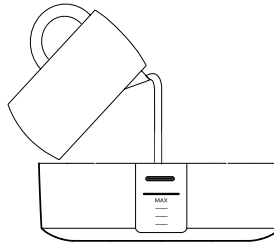

- Reassemble the water tank. Align the tank lid with the tank base (1). Push down on the tank lid (2) until the tab on the tank lid snaps securely over the hook on the tank base (3). When the tank lid is attached correctly there should be no gap between the tank lid and the tank base (4).

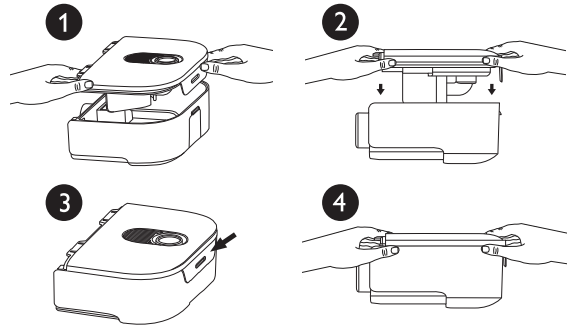

- Slide the water tank back into the humidifier. Ensure that it is fully connected before proceeding.

Note:

A pop-up message will appear if the water tank is not fully connected.

Warning

When installing the tank, do not allow any water to spill into the humidifier or therapy device.

- Attach the tubing connector to the air outlet port. If you are not using a 12mm tube, use the 15mm/22mm tube adapter.
- Supply power to your therapy device. Refer to the manual included with your therapy device.
- Put on your mask assembly. Refer to the instructions supplied with your mask.
- Turn on the airflow on your device and begin therapy. Refer to the manual included with your therapy device for instructions on how to turn therapy on and off.

Caution

Do not turn the humidifier on without the water tank installed. The humidifier setting must be "0" (off) if there is no water in the water tank.

Note

If you are having trouble with your mask, refer to the instructions included with the mask.

Disconnecting the humidifier

Caution

To avoid spilling, do not disconnect the humidifier from the therapy device with water in the tank. Remove the water tank from the humidifier before disconnecting the therapy device.

1. Disconnect power to the therapy device and tubing.
2. Remove the water tank from the humidifier.
3. Pick up the system.
4. Remove the humidifier by sliding the latch on the bottom of the humidifier, and pulling the humidifier away from the therapy device.

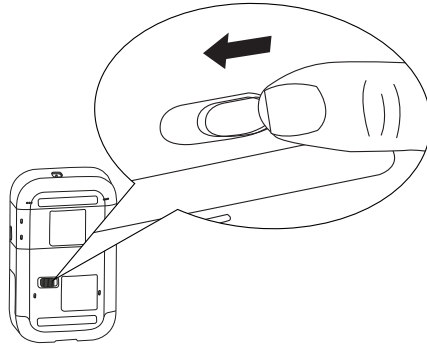

5. Cleaning

Warning

Allow the humidifier heater plate and water to cool down for approximately 15 minutes before removing the water tank. A burn may result from: touching the heater plate, coming in contact with the heated water, or touching the tank pan.

Note

Refer to the DreamStation Go therapy device user manual for tube cleaning instructions.

Cleaning the water tank base

Hand washing can be performed daily. Dishwashing can be performed weekly.

Warning

Clean the tank base daily to prevent mold and bacteria growth.

1. Remove the water tank from the device and then remove the tank lid.
2. Wash the tank base in the dishwasher (top shelf only) or in a solution of warm water and a mild liquid dishwashing detergent (1 teaspoon of liquid dishwashing detergent per gallon of warm water). Rinse with clean water. Wipe the top and bottom of the tank base. Allow the tank base to air dry.

Caution

Use a mild liquid dishwashing detergent only for either hand washing or when using a dishwasher.

3. Inspect the tank base for damage and ensure that the CPAP seal is in place. If the tank base shows signs of wear or damage, contact your supplier for a replacement.

Cleaning the tank lid and components

Warning

Clean the tank lid and its components daily to prevent mold and bacteria growth.

Cautions

- Use a mild liquid dishwashing detergent only (1 teaspoon of liquid dishwashing detergent per gallon of warm water).
- Do not wash the tank lid in a dishwasher. Hand wash only.

1. Remove the manifold (1) by pulling up on both manifold tabs.

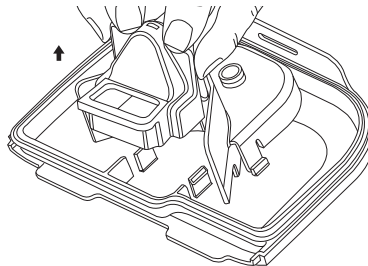
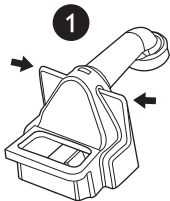

2. Remove the baffle (2) by pressing in on the side tabs and pulling up on the baffle.

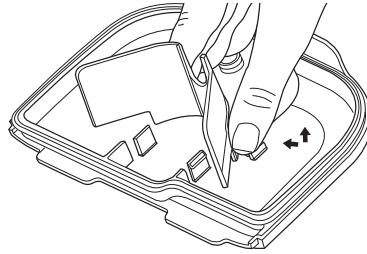
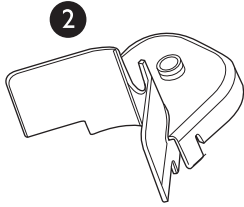

3. Wash the lid and components in a solution of warm water and a mild dishwashing detergent. Rinse with clean water.

4. Allow components to air dry.

5. Reassemble the baffle. Align the tabs on the baffle with the hooks on the tank lid. Press down until the tabs on each side of the baffle snap into place.

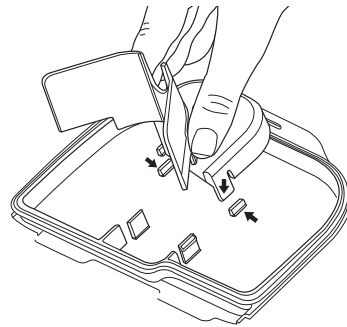

6. Reassemble the manifold. Align the manifold with the hooks on the tank lid. Gently press down on both manifold blocks until they snap into place.

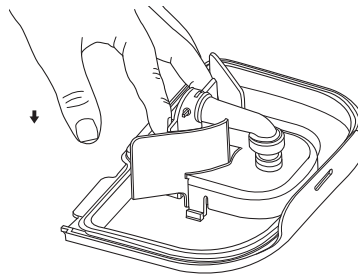
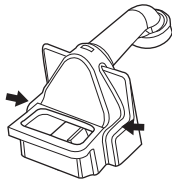

7. Gently press down on the manifold tube until it snaps into the baffle.

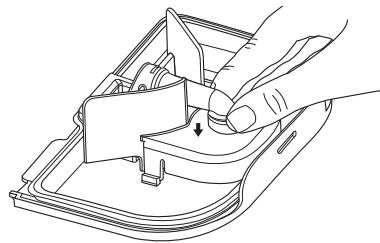

6. Maintenance instructions

Warning

Allow the humidifier heater plate and water to cool down for approximately 15 minutes before removing the water tank. A burn may result from: touching the heater plate, coming in contact with the heated water, or touching the tank pan.

Maintaining the water tank base

If you use tap water in your humidifier water tank, follow the steps below to maintain the tank base. Perform these steps monthly or more frequently, as needed.

1. Remove the water tank from the humidifier.
2. Remove the lid from the water tank.
3. Wipe the inside of the tank base with a damp cloth to remove any debris.
4. Fill the tank base with undiluted white vinegar (5% acetic acid) and soak for a minimum of four hours or until the tank base is visually clear of mineral build up.
5. Empty the vinegar from the tank base.
6. Thoroughly rinse the tank base with water.
7. Inspect the tank base for any damage and replace it if necessary.

Maintaining the humidifier base

Perform these steps bi-weekly or more frequently, as needed.

1. Remove the water tank from the humidifier.
2. Disconnect the humidifier from the therapy device.
3. Wipe the humidifier base and heater plate with a damp cloth. Allow the platform to air dry before reconnecting to the therapy device.
4. Inspect the humidifier base for any damage and replace it if necessary.

7. Troubleshooting

The table below lists some of the problems you may experience with your humidifier and possible solutions.

| Problem | Why it happened | What to do |
|---|---|---|
| The humidifier and/or components are cracked or damaged. | The humidifier was dropped or mishandled. | If the humidifier does not operate properly after being dropped or mishandled, contact your supplier or Philips Respironics. |
| The therapy device is operating but the humidifier's airflow is low or stopped. | The humidifier has an airflow obstruction. | Contact your supplier or Philips Respironics. If the problem cannot be resolved, return the humidifier to your supplier to determine the problem. |
| High Leak | The tubing is not connected correctly and doesn't seal properly. | Remove your mask and tubing and check for kinks or tears. If it is torn or damaged, contact your supplier or Philips Respironics for replacement tubing and/or mask. If the tubing is not damaged, reattach your tubing, turn on the airflow, and check to make sure you do not still feel air coming out of the port area. |
| | The therapy device is not seated correctly against the humidifier. | Remove the therapy device from the humidifier and reconnect. Make sure the air inlet port on the humidifier connects securely to the air outlet port on the device. If high leak persists, issue may be caused by a missing, misaligned or damaged seal. Verify that the tank lid is properly seated. If needed, gently press around the perimeter of the tank lid to reseal it. |
| | The humidifier tank is not properly seated in the humidifier. | Remove the water tank from the humidifier base, and then place the tank back in the humidifier, making sure it is completely seated. If high leak persists, issue may be caused by a misaligned or damaged seal. Ensure that the CPAP seal is present. If a seal has come loose, gently press around the edges of the seal to reseal it. |
| Excessive condensation in the tubing. | The humidity level setting is too high. | Reduce the humidity level setting or set the humidifier to adaptive humidification. |
| | The humidifier is positioned incorrectly. | Verify that the humidifier and therapy device are away from air conditioning equipment. |
| The humidifier has fallen off your table or night stand. | The humidifier may not have been properly seated on the night stand, or the placement of the tubing may have caused the device to fall. | Always make sure your humidifier is placed on a hard, flat surface so the rubber feet on the bottom of the humidifier base can adhere to the surface (make sure there is no fabric under the base). The humidifier must be level for proper operation. Also, place the humidifier away from the edge of the night stand or table, so it doesn't accidentally get knocked off the table. If the humidifier falls and water gets into the therapy device, drain all water out of the therapy device. Allow it to air dry to make sure it is completely dry before reapplying power. If the placement of the tubing causes the humidifier to fall, make sure that you use proper hose management when setting up your device. Route the tubing behind the bed's headboard. If the humidifier does not operate correctly after falling, contact your supplier or Philips Respironics. |

| Problem | Why it happened | What to do |
|--|--|---|
| I'm having difficulty adjusting the heated humidifier setting. | The blower is not turned on, or the humidifier is not fully connected. | The humidifier setting can only be adjusted when therapy is turned ON. Confirm that the blower is turned on, and that the humidifier icon appears on the left side of the screen, then adjust to desired comfort. If the blower is on but the humidifier settings are not displayed on the Therapy ON screen, then unplug the device. Confirm that the humidifier electrical contacts are not obstructed or damaged. Then reconnect the humidifier and reconnect the device's power supply. Turn the blower on; if the settings are still not visible, contact your supplier or Philips Respironics for assistance. |
| The water in the water tank runs out before morning. | Water tank was not full at start of session. Mask leak is excessively high. The ambient conditions are very dry/cool. | Under most conditions, a full water tank should last for a typical sleep session. However, many factors impact water consumption, including: the ambient temperature and humidity in your bedroom, your humidifier settings, the level of mask leak, and the duration of your sleep session. First, make sure that the water tank is filled to the maximum fill line at the start of your sleep session. Check that your mask is fitted properly, and adjust as needed to reduce mask leak to normal levels. You may use the Check Mask Fit function to evaluate your mask fit. Also, confirm that the device, humidifier, humidifier seals, and tube are connected properly and not leaking. You may also choose to lower your humidifier settings, change the humidification mode from Fixed to Adaptive humidification mode, or adjust the Target Time setting to increase the time that your humidifier water will last. |
| I hear a leak or whistling sound coming from my therapy device or humidifier (not related to mask leak). | The therapy device air inlet may be obstructed. The humidifier or tube is not fully connected. The humidifier seals are not fully seated or are missing. | Check therapy device air inlet is not obstructed and filters are clean and properly inserted. Confirm that the device, humidifier, and tube are connected properly and not leaking. Confirm that the humidifier tank lid is properly seated; if needed, gently press around the perimeter of the tank lid to reseal it. |
| I accidentally spilled water into my humidifier base. | The water tank has been filled beyond the maximum fill line. | A small amount of water spilled on the base of the humidifier will not harm your device. A small spill in the humidifier will evaporate under normal humidifier use. However, too much water in the humidifier water tank could spill over the tank lid and might damage your furniture. Disconnect power from the device. Remove the water tank, pour out any excess water until the water level is at or below the maximum fill line and set the water tank aside. Separate the humidifier from the therapy device, and pour out the spilled water. Once the heater plate has cooled, wipe the humidifier with a paper towel or soft cloth. If needed, dry the underside of the humidifier and confirm that your table top is dry. Reconnect the humidifier and power supply, and reinstall the water tank. |

Note

For information on troubleshooting your therapy device, see the manual included with your therapy device.

8. Additional notes

Traveling with the system

1. Remove the water tank and empty all water and allow to air dry.
2. Put the empty water tank back into the device.
3. Pack your humidifier in your carry-on luggage.

Caution

Do not move the humidifier while the water tank has water in it.

When you are traveling, the optional carrying case for your therapy device can be used for carry-on luggage only. The carrying case will not protect the humidifier if it is put through checked baggage.

For your convenience at airport security stations, there is a note on the bottom of the humidifier stating that it is medical equipment. It may be helpful to bring this manual along with you to help security personnel understand the device.

If you are traveling to a country with a line voltage different than the one you are currently using with the therapy device, a different power cord or an international plug adapter may be required to make your power cord compatible with those where you visit. Contact your supplier for additional information.

Service

The humidifier does not require routine servicing. If any part of the humidifier is worn or damaged, contact Philips Respironics or your supplier. See the *Troubleshooting* section in this manual for additional information.

Disposal

Dispose of this device in accordance with local regulations.

9. DreamStation Go Heated Humidifier specifications

Environmental

| | |
|---|--|
| Operating Temperature | Device: 5° to 35°C (41° to 95°F) |
| Storage Temperature | -20° to 60°C (-4° to 140°F) |
| Relative Humidity (operating & storage) | 15 to 95% (non-condensing) |
| Atmospheric Pressure: | Device: 101 to 77 kPa (0 - 2286 m / 0 - 7500 ft) |

Physical

| | |
|--|---|
| Dimensions with therapy device | 253 mm L x 151 mm W x 59 mm H (9.96 in L x 5.95 in W x 2.32 in H) |
| Weight (empty water tank with therapy device and power supply) | 1259 g (2.8 lbs) |

Service life

The expected service life of the DreamStation Go heated humidifier is five (5) years.

The expected service life of the DreamStation Go heated humidifier water tank is one (1) year.

Standards compliance

This device is designed to conform to the following standards:

- IEC 60601-1 General Requirements for Basic Safety and Essential Performance of Medical Electrical Equipment
- ISO 8185 General Requirements for Humidification Systems
- ISO 80601-2-70 Sleep Apnea Breathing Therapy Equipment
- EN 60601-1-2 Electromagnetic Compatibility

IEC 60601-1 classification

| | | |
|---|---|--|
| Type of Protection Against Electric Shock | Class II Equipment/Internally Powered | |
| Degree of Protection Against Electric Shock | Type BF Applied Part | |
| Degree of Protection Against Ingress of Water | <p>Device: Drip Proof, IP22</p> <p>First characteristic numeral - 2 - Protection against ingress of solid foreign objects \geq 12.5 mm diameter.</p> <p>Explanation: Protected against access to hazardous parts with a finger and protected against solid foreign objects of 12.5 mm diameter and greater.</p> <p>Second characteristic numeral - 2 - Protection against ingress of water with harmful effects dripping (15° tilted).</p> <p>Explanation: Protected against vertically falling water drops when enclosure tilted up to 15°.</p> | |
| Mode of Operation | Continuous | |
| Electrical (when the heated humidifier is used with the DreamStation Go therapy device) | AC Power Consumption: 100–240 VAC, 50/60 Hz, 2.0–1.0 A | |
| Maximum recommended pressure | 20 cm H ₂ O | |
| Water capacity | 240 ml (8 oz.) at recommended water level | |
| Heater plate | Max Temperature: 68°C (154°F) | |
| Inhalation pressure drop of humidifier | Max: 2.1 cmH ₂ O at 60 LPM Flow | |
| Exhalation pressure drop of humidifier | Max: 2.8 cmH ₂ O at 20 LPM Flow | |
| Humidity | <p>Humidity_{min} Output: 12 mg H₂O/L</p> <p>Measured @ expected leak across therapy pressures, 15.9–35° C, 15% RH, for all compatible tubes</p> | |
| Maximum delivered gas temperature | <43°C (109.4°F) | |

Declared dual-number noise emissions values (in accordance with ISO 4871)

| Tube Size | Sound Pressure Level (L) | Uncertainty (K) | Sound Power Level | Uncertainty (K) |
|---------------------|--------------------------|-----------------|-------------------|-----------------|
| 12 (mm) tubing type | 33.9 dB(A) | 2.0 db(A) | 41.9 dB(A) | 2.0 dB(A) |
| 15 (mm) tubing type | 33.3 dB(A) | 2.0 db(A) | 41.3 dB(A) | 2.0 dB(A) |
| 22 (mm) tubing type | 33.2 dB(A) | 2.0 db(A) | 41.2 dB(A) | 2.0 dB(A) |

Pressure accuracy

Pressure Increments: 4-20cm H₂O (in 0.5 cm H₂O increments)

Maximum static pressure accuracy, according to ISO 80601-2-70:2015:

| Tube Type | Pressure | Accuracy |
|---------------------|------------------------|----------------------------|
| 12 (mm) tubing type | 10 cm H ₂ O | ± 1.0 cm H ₂ O |
| 15 (mm) tubing type | 10 cm H ₂ O | ± 0.55 cm H ₂ O |
| 22 (mm) tubing type | 10 cm H ₂ O | ± 0.55 cm H ₂ O |

Static pressure accuracy has a measurement uncertainty of 3.8%

Maximum dynamic pressure variation, according to ISO 80601-2-70:2015:

| Tube Type | 10 BPM | 15 BPM | 20 BPM |
|---------------------|----------------------------|----------------------------|----------------------------|
| 12 (mm) tubing type | ± 1.20 cm H ₂ O | ± 1.51 cm H ₂ O | ± 1.67 cm H ₂ O |
| 15 (mm) tubing type | ± 0.99 cm H ₂ O | ± 1.34 cm H ₂ O | ± 1.31 cm H ₂ O |
| 22 (mm) tubing type | ± 0.89 cm H ₂ O | ± 1.26 cm H ₂ O | ± 1.38 cm H ₂ O |

Dynamic pressure accuracy has a measurement uncertainty of 3.6%.

Maximum flow rate (typical)

| Tube Type | Flow | Test pressures (cm H ₂ O) | | | | |
|---------------------|---|--------------------------------------|-----|-----|-----|-----|
| | | 4 | 8 | 12 | 16 | 20 |
| 12 (mm) tubing type | Average flow at the patient connection port (l/min) | 87 | 77 | 77 | 83 | 85 |
| 15 (mm) tubing type | Average flow at the patient connection port (l/min) | 97 | 95 | 90 | 90 | 93 |
| 22 (mm) tubing type | Average flow at the patient connection port (l/min) | 107 | 106 | 107 | 106 | 106 |

Limited Warranty

Respironics, Inc., a Philips company, warrants that the system will be free from defects of workmanship and materials and will perform in accordance with the product specifications from the date of sale by Respironics, Inc. for a period of two (2) years. If the product fails to perform in accordance with this limited warranty, Respironics, Inc. will repair or replace, at its option, the defective material or part provided the product is returned to Respironics, Inc. within the Warranty Period. This is the sole and exclusive remedy for breach of this limited warranty.

This warranty is non-transferable and applies only to the original owner of the product. This warranty does not cover damage caused by accident, misuse, abuse, alteration, water ingress, failure to use or maintain the product in accordance with the product literature, and other product failures not related to materials or workmanship. Note that damage occurring during return shipment is not covered by this warranty, so it is recommended that for your protection you return product by insured mail, insurance prepaid. Respironics, Inc. will pay customary freight charges from Respironics, Inc. to the original purchaser only.

RESPIRONICS, INC. DISCLAIMS ALL LIABILITY FOR ECONOMIC LOSS, LOSS OF PROFITS, OVERHEAD, OR INDIRECT, CONSEQUENTIAL, SPECIAL, OR INCIDENTAL DAMAGES WHICH MAY BE CLAIMED TO ARISE FROM ANY SALE OR USE OF THIS PRODUCT. Some states do not allow the exclusion or limitation of incidental or consequential damages, so the above limitation or exclusion may not apply to you.

THIS WARRANTY IS GIVEN IN LIEU OF ALL OTHER EXPRESS WARRANTIES. IN ADDITION, ANY IMPLIED WARRANTIES – INCLUDING ANY WARRANTY OF MERCHANTABILITY OR FITNESS FOR THE PARTICULAR PURPOSE – ARE SPECIFICALLY DISCLAIMED. Some states do not allow disclaimers of implied warranties, so the above disclaimer may not apply to you.

This warranty gives you specific legal rights, and you may also have other rights which vary from state to state.

To exercise your rights under this warranty, contact your local authorized Respironics, Inc. dealer or contact Respironics, Inc. at:

1001 Murry Ridge Lane
Murrysville, Pennsylvania 15668-8550
1-724-387-4000



Respironics Inc.
1001 Murry Ridge Lane
Murrysville, PA 15668 USA



REF 1140901

1140901 R01
ZL 01/17/2019
EN-DOM