

EcoStar



Patient Manual

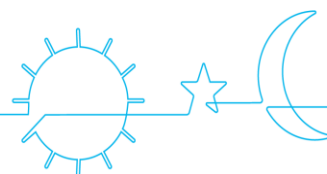

TABLE OF CONTENTS

Before starting	3
Safety instructions.....	3
Intended use	4
Adverse effects	4
Contraindications.....	4
Checking the components	4
Description of the device	5
Views of the Device	5
Symbols on the device.....	6
Installation	7
Standard installation of the device.....	7
Installing the GoodKnight H ₂ O humidifier	7
Installation for use with battery or cigar lighter power	7
Use	8
Starting treatment	8
Stopping treatment.....	8
Mask disconnected feature	8
Transporting the device.....	8
Ramp feature.....	9
Accessing information on the device.....	9
Use with added oxygen (optional)	12
Installation with an oxygen adapter (optional).....	12
Starting and stopping treatment.....	12
Cleaning and Maintenance	13
Weekly.....	13
Monthly	13
Trouble-shooting	14
Helpful hints.....	14
Device messages.....	15
Technical characteristics	16
Device performance	16
Conditions of use.....	16
Electrical characteristics	16
Transport and storage conditions	16
Physical characteristics.....	16
Electrical characteristics of the power supply module.....	17
Standards Compliance	17
Disposing of the device at the end of its life.....	17
CE marking.....	17

Before starting

Please read this manual carefully before using your device so that you fully understand the limitations of this device.

Safety instructions

WARNING

In this manual, this signals a risk of injury or accident to you or to others.

- Only use the EcoStar device for its intended purpose indicated in this manual. The advice given in this manual does not replace the instructions of your health care provider.
- The device is not intended to provide assistance for vital functions.
- It must only be used with the circuits, masks, fittings and accessories recommended by a physician or supplied by your home care provider. Confirm the 'Directions for Use' instructions for each accessory are in the package and read them carefully.
- When a facial mask is necessary, always use one which is equipped with an anti-asphyxia valve.
- If you suspect that the device or one of the accessories is defective, damaged or not working properly, please contact your home care provider.
- Use only with the power supply module provided with the device.
- Do not try to open or modify the device. Maintenance of this equipment is to be performed by skilled personnel only. Contact your home care provider.
- If the device is connected to a base of multiple sockets, an additional base of multiple sockets or an extension wire should not be connected to the system.
- If necessary, the device can be detached from the electrical network by unplugging the power cord. Make sure that the power cord is accessible.
- Place the device on a stable horizontal surface in a clean, dry environment. Keep the device away from sources of water.
- Keep the device away from children and pets or pests.
- In the event of additional oxygen supply, scrupulously observe the safety instructions for using oxygen.
- Once the mask is in place, make sure that the device produces airflow. If not, remove the mask immediately and contact your home care provider.



- Be careful not to obstruct the air outlet, or any other opening of the device or respiratory circuit, either accidentally or intentionally. Avoid covering the device or placing it too close to a wall. Do not introduce liquids or objects into the air outlet.
- Never block the mask exhalation vent, which allows air to be expelled continually and reduces to a minimum the re-inhalation of carbon dioxide. When the CPAP device is turned on and is functioning properly, fresh air from the CPAP device flushes the exhaled air out through the interface vent hole. However, when the device is not operating, insufficient fresh air is produced in the mask presenting a risk of re-inhaling exhaled air, which under certain circumstances could lead to a risk of suffocation within several minutes.
- At lower CPAP pressures, the flow through the exhalation port may be inadequate to clear all exhaled gas from the hose. There may also be a risk of re-inhalation.
- If the device experiences a loss of power or a malfunction, remove the mask.
- Do not leave long pieces of unused tubing on the bed, to prevent them from wrapping around your head or neck while you sleep.

CAUTION

In this manual, this indicates that there is a possibility of material damage to this device or any other device.

- The EcoStar device cannot be used without a medical prescription. Under no circumstances should you attempt to adjust these prescribed settings without the agreement of your medical team.
- Since this is a medical electrical device, please follow the installation instructions contained in this manual concerning electromagnetic compatibility indicated by your home care provider.
- Like all medical electrical devices, the device is vulnerable to interference from mobile and portable radiofrequency communication equipment (cordless phones, WiFi) which could be placed nearby, except in the case of use with the GoodKnight H₂O humidifier.

If the device is used with the GoodKnight H₂O heating humidifier:

- Refer to the safety instructions in the user manual for your humidifier.
- When using the humidifier's water chamber, take precautions to eliminate the risk of introducing water into the device, which can cause irreversible damage. Make sure that the humidifier is always lower than the device.
- Fill the water chamber away from the device to avoid spilling water on the device before connecting it to the humidifier.
- Place the heating humidifier and the EcoStar device on a flat, stable surface and keep them away from sources of flames.
- Never put the heating humidifier on top of the device as water could enter the device and damage it.
- After use, disconnect the humidifier from the device to avoid exposing the device to humidity.
- Adding a humidifier may affect the device performance.
- Disconnect the device from the heating humidifier and empty the water chamber before moving or transporting the assembly.

Intended use

The EcoStar device is a Positive Pressure device indicated for the mask treatment of Sleep Apnea Syndrome (SAS) in patients weighing more than 30 kg (66 lbs). It can be used at home or in a sleep center.

The device can be used with the GoodKnight H₂O humidifier if a prescription for heated humidification has been added to the patient's treatment. The heated humidifier is designed to heat and raise the humidity of the air delivered to the patient through the Continuous Positive Airway Pressure (CPAP) device.

Adverse effects

Please contact your health care professional if you develop the follow symptoms when using the device: unusual thoracic pains, severe headache, dyspnea increase, airway or nasal passage dryness, skin sensitivity, runny or bleeding nose, discomfort or pain in ear or sinus, bloating, daytime drowsiness, mood changes, disorientation, irritability or memory loss.

Contraindications

Studies have shown that the use of positive airway pressure is contraindicated for certain patients with one of the following pre-existing conditions:

- Severe bullous emphysema or emphysema previously complicated by pneumothorax.
- Pneumoencephalus, trauma or recent surgery with sequela of cranio-nasopharyngeal fistula.
- Decompensated cardiac insufficiency or hypotension, particularly in case of decreased blood volume or cardiac arrhythmia.
- Dehydration.
- Massive epistaxis or history of massive epistaxis.
- Acute sinusitis, otitis media, or perforated tympanic membrane.
- Tracheotomy.

Checking the components

The device is delivered with the following components:

- Power supply
- Carrying case
- Patient manual
- Air inlet filter
- Patient circuit

It can also be used with the following optional accessories. For more information about available accessories, contact your home care provider. When using the accessories, follow the instructions provided.

- GoodKnight H₂O

Description of the device

The EcoStar device is powered by an external electrical power supply module and comes with specific accessories

Views of the Device

Figure 1 View of the user interface

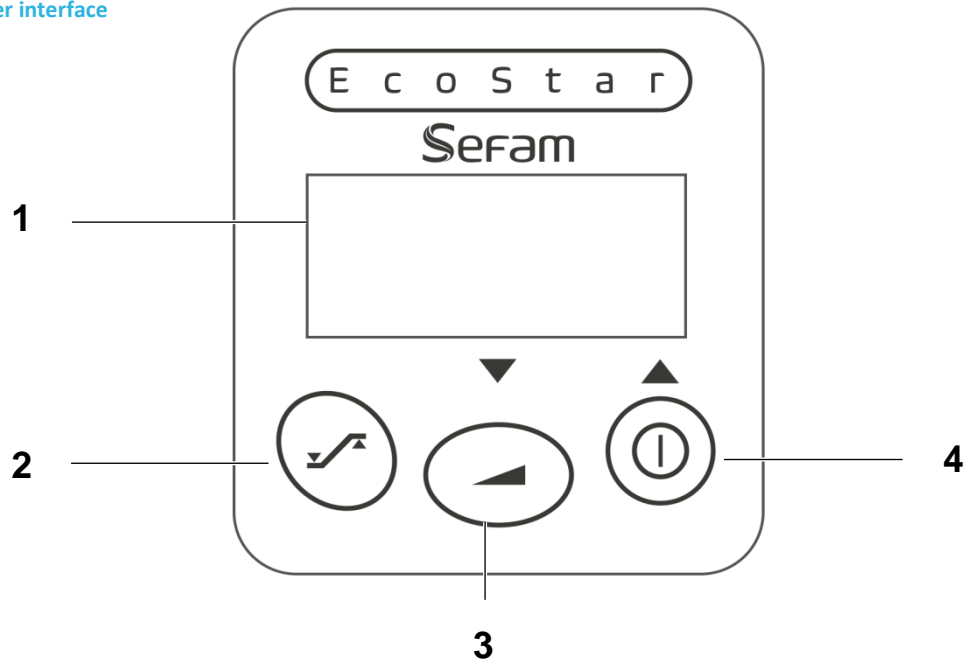

- | | | |
|---|---------------------------|---|
| 1 | Display | this allows viewing information such as the pressure delivered and the device settings. |
| 2 | Information access button | this allows access to information about the device. |
| 3 | Ramp button | this allows disabling the pressure ramp. It is also used to decrease the value of the parameters during the device settings. |
| 4 | On/Off button | this allows turning on or off the device. It is also used to increase the value of the parameters during the device settings. |

Figure 2 View of the front side

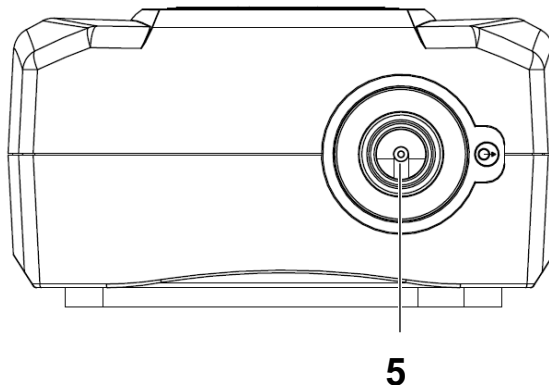

- | | | |
|---|------------------|--|
| 5 | Outlet connector | air outlet to which the tubing is connected. |
|---|------------------|--|

Figure 3 View of the rear side

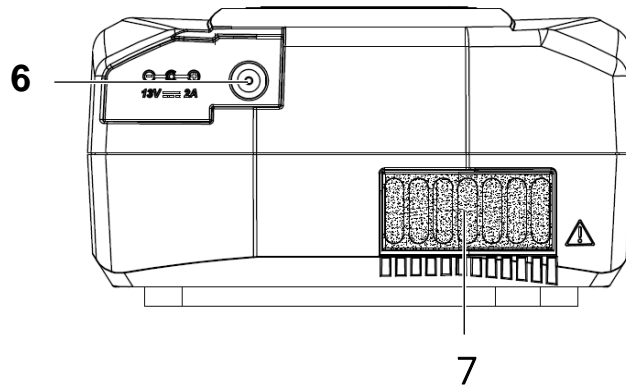

- 6 Supply connector this allows powering the device by the power supply module or by an external battery.
- 7 Air inlet filter prevents dust from entering the device and the airflow.

Symbols on the device

Symbol	Description	Symbol	Description
	On/off button symbol.		Ramp button symbol.
	Symbol for raising the value of the parameter displayed on the screen.		Symbol for lowering the value of the parameter displayed on the screen.
	Information access button symbol.		Outlet symbol.
IP21	Device is protected against the penetration of solid objects larger than 12 mm and against falling drops of water.		Device at the end of its life, separate from household waste for disposal. For further information, refer to "Disposing of the device at the end of its life" on page 17.
	Class II device.		BF-type device.
	Direct current power supply.		Direct current.
	Refer to the user manual.		Specific warning (see "Safety instructions" on page 3).
	Device complies with the requirements of European Directive 93/42/EC on medical devices.		Keep dry.

Installation

Standard installation of the device

1. Connect the end of the tubing to the outlet connector of the device (Item 5 of Figure 2 on page 5).

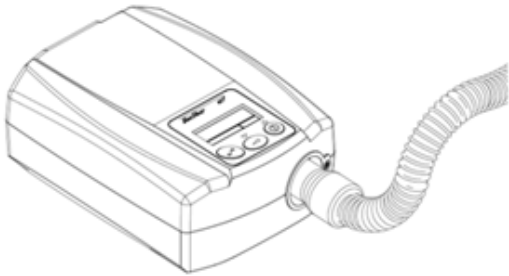

2. Prepare the mask as described in the operating instructions which came with the mask.
3. Connect the mask to the other end of the patient circuit.
4. Connect the power supply module cord into the supply connector on the rear side of the device (Item 6 of Figure 3 on page 6) and the power supply module plug into the power outlet.
5. "SEFAM" is displayed, followed by the next standby screen. The device is ready to operate.



Installing the GoodKnight H₂O humidifier

Please see your GoodKnight H₂O's user manual to prepare the humidifier and proceed with installation on your device.

Then continue with steps 2 through 5 of the standard installation procedure.

Installation for use with battery or cigar lighter power

The EcoStar device can be powered by a 12-Volt battery by connecting one end of the specific optional cable to the supply connector on the rear side of the device (item 6 of Figure 3 on page 6) and the other end directly to the battery.

The device also can also be powered from a cigarette-lighter socket using an optional cable specially designed for this purpose. To do this, connect one end of the cigarette-lighter cable to the supply connector on the rear side of the device (Item 6 of Figure 3 on page 6) and the other end directly to the cigarette-lighter socket.

CAUTION

- Do not use a battery power cable other than the one intended with the device. There would be a risk of damaging the device and your battery.
- Use only a 12-volt DC power source and observe the correct connection polarity (+and -).

Use

Starting treatment

1. Put the mask in place according to the instructions which came with the mask. If a mask with exhalation vent is used, it includes a hole by which the exhaled gases will be flushed and could not be rebreathed. If the mask does not have an exhalation vent, your physician must provide you with an attachment for expelling air as closely as possible to the nose.
2. Press the on/off button  to begin treatment. The prescribed pressure or the actual pressure is displayed on the screen, according to the setting that you carried out.



Indicates that the device is operating

3. If you use a heating humidifier, turn it on according to the instructions which came with the humidifier.
4. The symbols which may be displayed on the screen are summarized in the table entitled "Description of symbols displayed on the screen" on page 10.

WARNING

Following a power supply interruption, the device will resume the same mode it was in (on/off) before the disconnection.

Stopping treatment

1. If you use a heating humidifier, turn it off according to the instructions which came with the humidifier. Always unplug the humidifier before turning off the device.
2. Remove the mask.
3. Press the on/off button  to turn the device off. The device will go into standby mode and display "Eco". You can then unplug the power supply module cord from the power outlet.

Mask disconnected feature

If you remove your mask, the device automatically switches to low power. The machine will restore normal power when you reconnect your mask, or it will stop if you press the on/off button .

This feature can be used at night if you need to get out of bed.

Transporting the device

Unplug the power supply module and disconnect all the device's accessories. Place the power supply module, the accessories and the device in the carrying case.



CAUTION

Disconnect the device from the GoodKnight H₂O heating humidifier and empty the water chamber before moving or transporting the assembly, to eliminate any risk of introducing water into the device and thereby causing irreversible damage.

Ramp feature

If activated by your home care provider, this feature allows for a gradual rise in pressure to help you go to sleep: therefore, treatment begins at a low pressure called the comfort pressure, and rises from there to the pressure for treatment.

The pressure rise time is prescribed by your medical team and is set by your home care provider.

1. Press the on/off button  to start the ramp. The ramp indicator  is displayed.

Note:

If the ramp time is set at zero, the ramp feature is disabled.

2. Press the ramp button  to turn the ramp feature off. You can reactivate it by stopping and restarting the device by pressing the on/off button twice.

The value of the comfort pressure can be changed. To do that, refer to the "Device setting" paragraph on page 10.

Accessing information on the device

The three buttons on the front of the device allow access information on the device and are used to change the value of the parameters for certain settings.

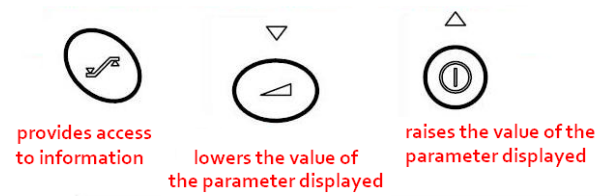











The parameters accessible on the screen when the machine is in standby or operating mode are:

- parameters of the device relating to your treatment
- the compliance data which has been recorded.

Each screen of the patient settings menu includes:

- an upper section indicating the value of the parameter displayed
- a lower section which includes various symbols indicating whether the machine is on or off, as well as the nature of the parameter displayed (see table entitled "Description of symbols displayed on the screen" on page 10).

Description of symbols displayed on the screen

Symbol	Description	Symbol	Description
	Standby mode		Operating mode
	Ramp feature		Pressure symbol
	Time symbol		Compliance symbol
	Adjustable parameter		Software version
	Information message		Error message





Device setting

The display allows information for the device's settings to be viewed. The information is available whether the device is on standby or in use.

To access the device settings:

press the information access button  for one second.

On the screen which appears:

- the  symbol or the  symbol shows if the device is on standby or in use.
- the  symbol indicates that the parameter displayed can be modified. Raise the value of the parameter by pressing the on/off button  or lower it using the ramp button .

To access the next data:

press the information access button .

To exit the parameter settings menu:

press the information access button  again.

The display will indicate "Eco" (in standby mode) or the prescribed pressure (in operating mode).

Notes:

- Exiting the parameter setting menus happens automatically if you do not press any buttons for 30 seconds.
- In the information access sequence below, the device is shown in operating mode and all the values displayed are given by way of example.

1
Press

for one
second.



Pressure set by the physician (corresponding to the pressure prescribed when the device is operating).

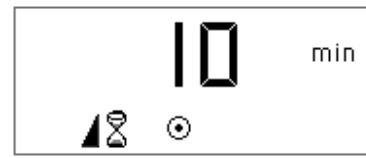

2
Press

Ramp time set by the physician (time the device takes to reach the prescribed pressure when starting from the comfort pressure).

3
Press



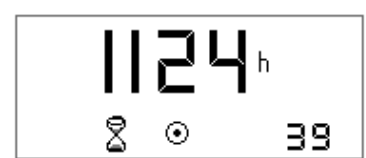

Comfort pressure (level of pressure produced by the device when the ramp feature starts up); this parameter is only displayed if the ramp time is not 0. The  symbol indicates that you can raise or lower the value displayed by using the button  or .

4
Press

Value of the **hour counter** (device operating time). The value displayed on the right below represents the minutes.

5
Press

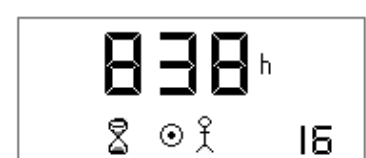
Value of the **compliance counter** (time during which you actually breathed with the mask). The value displayed on the right below represents the minutes.

6
Press



Selection of the pressure displayed: **prescribed pressure Pd** or **actual pressure Pr** (estimated at the mask). The selection is done by pressing the button .

7
Press



Software version included with the device. The version number is indicated by two digits (*); for example, the screen might display: Id 1.0.

Use with added oxygen (optional)

WARNINGS

- When using oxygen, always follow the instructions of the medical team or home care provider. The source of oxygen should be placed at over one meter of the device.
- Do not smoke in the presence of oxygen.
- Do not inject oxygen into the device's air intake.
- Carefully follow the instructions of the "Starting and stopping treatment" paragraph.
- If you use an oxygen concentrator or liquid oxygen unit, stop the flow of oxygen when the device is not operating. If the oxygen concentrator remains on when the device is turned off, the oxygen delivered into the patient circuit could accumulate inside the device, creating a fire hazard.
- The maximum flow of oxygen used must not exceed 12 l/min.

CAUTION

For a given oxygen flow, the concentration of oxygen inhaled varies as a feature of the pressure settings, your breathing, the type of mask used and the leak rate. This precaution applies to most Continuous Positive Airway Pressure devices.

Installation with an oxygen adapter (optional)

When using an additional oxygen supply, you must use a valve designed to prevent the accumulation of oxygen in the device.

This valve must be installed between the device and the patient circuit.

Refer to manufacturer's instructions for installation, cleaning and maintenance of the valve.

Starting and stopping treatment

1. It is essential that the device is turned on and generating air flow before the oxygen flow is started so that oxygen does not accumulate in the EcoStar device.
2. Likewise, you must stop the oxygen flow before turning off the device so that oxygen does not accumulate in the EcoStar device.

Cleaning and Maintenance

Please refer to the instructions for your mask, the heating humidifier and the respiratory circuit for more information about the care and maintenance of these items.

WARNING

Always unplug the device from the electrical source and disconnect the respiratory circuit from the device before cleaning.

CAUTION

- Use appropriate materials for cleaning: do not use harsh detergents, abrasive sponges or brushes with hard bristles.
- Do not let water come into contact with the device.

Weekly

Air inlet filter

- Remove the filter at the rear of the device.
- Wash the filter with warm water and mild detergent (for example 1 drop of dishwashing liquid on the filter).
- Rinse well to eliminate any trace of detergent.
- Dry the filter:
 - Press dry in a clean, absorbent cloth
 - Allow to dry completely away from sunlight
- Once dry, reinstall the filter at the rear of the device. Do not use a filter which is not completely dry.

Monthly

Device

- Clean the device exterior regularly by using a damp cloth or paper towel moistened with a little water and a drop of gentle detergent.
- Remove detergent residue by repeating this step with a clean cloth or paper towel, slightly moistened with just water.
- Wipe the entire device with a dry cloth or paper towel.

Air inlet filter

Change the filter whenever it is damaged or soiled.

WARNINGS

- Do not use detergent sprays. Chemical product residue could enter the air outlet, the filter's foam or the device interior, causing airway irritation.
- Never use the device without making sure that an air inlet filter is installed.

Trouble-shooting

Helpful hints

Problem	Possible cause	Solution proposed
Your nose is cold.	The room temperature is too low.	Raise the room temperature.
	The delivered air is too cold.	Place patient circuit under a blanket to reduce heat loss.
Runny Nose.	Reaction to the airflow and pressure.	Contact your medical technical team or your attending physician.
Nose or throat is dry or irritated.	The air is too dry.	Humidify the air in the room using a humidifier. Contact the medical technical team to obtain a heating humidifier.
Nose, sinus or ear pain.	Sinus infection or nasal congestion.	Contact the attending physician immediately.
The device is delivering too hot air.	The air inlet filter may be dirty. The air inlet is clogged.	Clean or replace filters as necessary (see chapter entitled "Cleaning and Maintenance" on page 13). Move the device away from all linens and clothing.
	Room temperature is too high.	Lower the room temperature. Make sure that the device is well away from any source of heat. Remove patient circuit from underneath the blanket.
Discomfort from feeling that the pressure is too high.	Device pressure.	Getting used to the nasal pressure takes some time. Use the pressure ramp when you go to sleep (see "Ramp feature", page 8). The pressure level will gradually increase before reaching the prescribed value and the ramp indicator will be displayed. Relax and breathe slowly through the nose. The pressure level has been prescribed by your physician; it can be changed only by medical prescription. If the pressure delivered by the device seems to have changed, contact your home care provider to have the device pressure checked.
The device does not display the correct pressure.	The ramp is enabled.	Confirm that the ramp indicator is displayed. Disable the ramp feature by pressing the ramp button.

Problem	Possible cause	Solution proposed
The device does not light up (no display).	The power supply module is not properly connected. No mains power. The device's internal fuse is defective.	Check the connections between the device, the power supply, and the power source. Plug another device (e.g., lamp, radio, etc.) into the power source to confirm that current is available at the source. Contact your home care provider.
The device seems to be experiencing interference and is not operating properly.	Excessive electromagnetic interference.	Move the device away from sources of interference, such as halogen lamps, cordless phones, etc.

CAUTION

If other problems occur, contact your home care provider.

Device messages

Message displayed	Description	Solution proposed
In 01	The mask is disconnected.	Check the connections between the mask, the patient circuit, and the device. This message disappears as soon as the mask is well connected.
In 02	The device has detected excess pressure for more than 10 seconds.	Contact your home care provider.
In 03	Reduction of the power supply voltage.	Check the connections between the power supply module, the device and the power outlet. Unplug the power supply module, then reconnect it to the power outlet. If the problem persists, contact your home care provider. Check the battery and replace it if necessary. If the message persists, contact your home care provider.
Er XX (XX = 2 digits).	The device has detected an operating fault.	Contact your home care provider.

Technical characteristics

Device performance

Device pressure range:	4 cmH ₂ O to 20 cmH ₂ O ± 1 cmH ₂ O device adjustable in increments of 0.5 cmH ₂ O
Maximum pressure at the patient-side connection port under single fault condition:	30 cmH ₂ O
Ramp time:	0 to 30 minutes ± 1 minute device adjustable in increments of 5 minutes
Patient-side connection aperture:	Conical connection of 22mm diameter.
Sound pressure level measured in accordance with NF EN ISO 17510-1: 2002:	27 dB(A)
Sound pressure level measured in accordance with NF EN ISO 17510-1: 2009:	29 dB(A)
Lifetime planned for the device:	5 years (8 hours per day)

Conditions of use

Absolute pressure range:	700 hPa to 1060 hPa
Temperature:	+5°C to +40°C (+41 °F to +104 °F)
	+5°C to +35°C (41 °F to 95°F) with GKH ₂ O humidifier
Relative humidity:	between 10% and 95% without condensation
Altitude range:	0 – 2,400 m approx. (7,900 ft approx.)

Electrical characteristics

Maximum power consumption:	20 W
Input voltage:	13 V
Current consumed at 20 cmH ₂ O with a 4 mm leak:	0.750 A.

Transport and storage conditions

Relative pressure range:	500 hPa to 1060 hPa
Temperature:	-20°C to +60°C (-4 °F to +140 °F)
Relative humidity:	up to 95% without condensation

Physical characteristics

Dimensions (D x W x H):	202 x 145 x 79 mm approx. (7.9 x 5.7 x 3.1 ins approx.), excluding the power supply module
Weight:	0.644 kg approximately (1.4 lbs approx.), excluding the power supply module

Electrical characteristics of the power supply module

Class II power supply: 

Input voltage: 100 – 240 VAC (-15%, +10%), 50/60 Hz (± 1 Hz)

Power supply module provided	Input current	Output voltage
NEWTIM SNT-M1601 (EU plug)	1 000 mA	13 V / 1.80 A
DELTA MEF-023A13C (EU plug)	600 - 800 mA	13 V / 1.80 A
POWERWIN PW-M024A-1Y120K (plug except EU)	600 mA	12 V / 2 A

WARNINGS

- Use only one of the above-mentioned specific power supplies provided with the device.
- The above-mentioned power supply modules are not intended to be repaired. If it stops working, please contact your home care provider for a replacement.

Standards Compliance

Risks pertaining to this medical equipment were assessed in accordance with the ISO 14971: 2007 standard, specifically with reference to global residual risk. The EcoStar device complies with the following directives and standards:

- IEC 60601-1:2005 + Amd1:2012: Medical electrical equipment. Part 1: General requirements for basic safety and essential performance.
- IEC 60601-1-2:2014: Medical electrical equipment – Part 1-2: General requirements for basic safety and essential performance – Collateral Standard: Electromagnetic disturbances – Requirements and tests.
- ISO 80601-2-70-1:2015: Medical electrical equipment – Part 2-70: Particular requirements for basic safety and essential performance of sleep apnea breathing therapy equipment.
- NF EN ISO 5356-1:2005 : Anaesthetic and respiratory equipment. Conical connectors.
- Council Directive 93/42/EC concerning medical equipment.
- European Parliament and Council Directive 2011/65/EC on the restriction of the use of certain hazardous substances (RoHS) in electrical and electronic equipment.
- European Parliament and Council Directive 2012/19/EC on waste electrical and electronic equipment (WEEE).

Disposing of the device at the end of its life

In compliance with European Directive 2012/19/EC this device is an electrical and electronic piece of equipment and must be collected and processed separately from household waste for disposal.

The symbol of the crossed out garbage bin (see paragraph "Symbols on the device", on page 6) indicates that this equipment must be collected and handled using an appropriate method of disposal.

Unsuitable disposal of the device at the end of its life could harm the environment.

Contact your home care provider.

CE marking

EcoStar : 2013.

Home care Provider Information

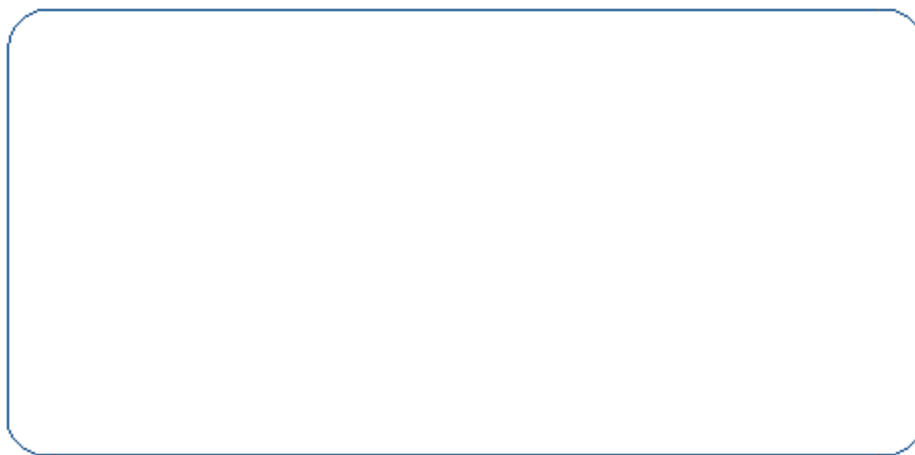

Manufacturer:	Manufacturing plant:
SEFAM 144 AV CHARLES DE GAULLE 92200 NEUILLY SUR SEINE FRANCE	SEFAM 10 ALLEE PELLETIER DOISY 54600 VILLERS-LES-NANCY FRANCE