

Electric Pilot System



Assembly, Operation, & Maintenance

Congratulations on your purchase, and thank you for selecting the Electric Pilot System from Blichmann Engineering™. We are confident that it will provide you years of service and many gallons of outstanding beer. This manual will familiarize you with the use, assembly, and the sanitation procedures for the product.



IMPORTANT INFORMATION

PLEASE READ AND THOROUGHLY UNDERSTAND THIS MANUAL PRIOR TO USE FOR IMPORTANT SAFETY INFORMATION!

WARNING: Sections labeled “Warning” can lead to serious injury or death if not followed. Please thoroughly read these sections and understand them completely before use. If you do not understand them or have any questions, contact your retailer or Blichmann Engineering (www.BlichmannEngineering.com) before use.

CAUTION: Sections labeled “Caution” can lead to equipment damage or unsatisfactory performance of the equipment. Please read these sections thoroughly. If you have any questions, contact your retailer or Blichmann Engineering (www.BlichmannEngineering.com) before use.

IMPORTANT: Sections labeled “Important” should specifically be followed to ensure satisfactory results with the product.

1BBL Pilot Systems come with Dual Element Controllers. All other systems will come with BrewCommander™ Controllers.

What’s In the Box?

Item Number	Description	Quantity
*	G2 BoilerMaker™	3
*	Dual Element Controller / BrewCommander™	*
*	BoilCoil™	*
aRipTide-Pump	RipTide™ Pump	2
HE-002-03	Therminator™	1
aThruMometer-1/2	ThruMometer Assembly 1/2"	1
AutoSparge	AutoSparge™	1
aWhirlPool-G2	Whirlpool Kit	*
aQR-Chiller-Bkt-LTE	Quick Release Chiller Bracket	1
QC-12ELBOW-01	QC 1/2" Elbow	7

Item Number	Description	Quantity
QC-12STEM-01	QC Stem - 1/2"	6
QC-12NUT-01	QC Nut 1/2"	13
BE-000105-00	O-ring - QuickConnector	13
aHex_nipple_12_NPT	1/2" Hex Nipple	2
BE-000641-00	3-way Ball Valve	*
BE-000359-00	Hose - Silicone Tubing	20 Feet
BE-000623-00	Flow Meter	1
aHERMSCoil-L	HERMS Coil	*
aRIMS-Rocket-240V-HopRocket	RIMS-Rocket™	*

* = Item Number and Quantity Depend on System Size

WATCH OUR PRO PILOT SYSTEM VIDEO AT: <https://tinyurl.com/propilotbe>

Receptacle Box Assembly

Remove the faceplate from the receptacle box. Locate the studs on the bottom of the table and install the receptacle box to the table using the fasteners on the studs. Reinstall the receptacle cover.

Table Assembly

Step 1: Set the table top upside down on the floor.

Step 2: There will be either 4 or 6 slots for legs on your table. Loosen all lock screws on the table and shelf. Set all legs in place and leave all set screws loose.

Step 3: Slide the shelf upside down onto the legs until the leg extends through the shelf bracket about 1 to 1 1/2 inches and tighten all set screws with the included allen wrench.

Step 4: Once the shelf and the set screws are tight, it's time to install the casters. The caster has a bolt running through it with a rubber outer casing. When the bolt is tightened the rubber will expand. Once the caster is placed into the leg, tighten the caster bolt to insure its securely in place. Flip the table over onto the casters.

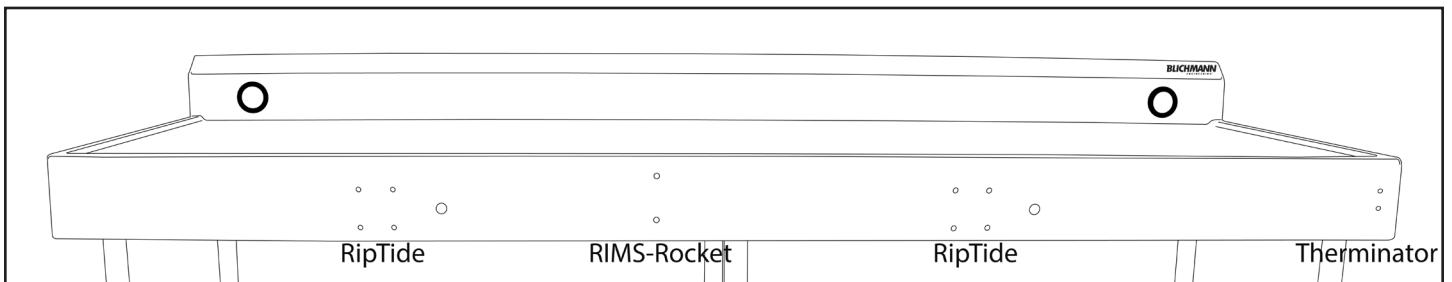

Electrical Requirements

System Size	240v 30 Amp GFCI L6-30R Outlet	120v 15 Amp GFCI Outlet
5	2	1
10	2	1
15	2	1
20	2	1
1BBI	4	1
20 Gal BrewEasy™	1	1
1 BBL BrewEasy™	2	1

Before continuing install the following items into your BoilerMaker™ kettles:

AutoSparge™

False Bottom

Temperature Sensors

- HERMS: Hot Liquor Tank (HLT) and Boil Kettle (BK)
- RIMS: HLT and Sensor Fitting on RIMS Rocket

BrewMometer™

- HERMS: Mash Tun (MT)
- RIMS: BK

Whirlpool Kits

- HERMS: HLT and BK
- RIMS: BK

BoilCoil™ Heating Elements

- HLT, BK, and RIMS Rocket (if applicable)

Installing the RipTide™ Pumps

- Step 1:** Mount the RipTide™ to the table with the 1/4-20 hardware. Make sure the pump head is facing to the left and the cord is on the right.
- Step 2:** Remove the grommet and slide the RipTide™ cable through the grommet and hole. Reinstall the grommet.
- Step 3:** Plug into the receptacle of the nearest BrewCommander™.
- Step 4:** Plug the 6ft 120v extension cable from the BrewCommander™ 120v cable (shown in Figure A) to the outlet on the bottom of the table.

If using the 1BBL with Dual Element Controllers Connect the RipTide™ cables into the outlet on the bottom of the table.

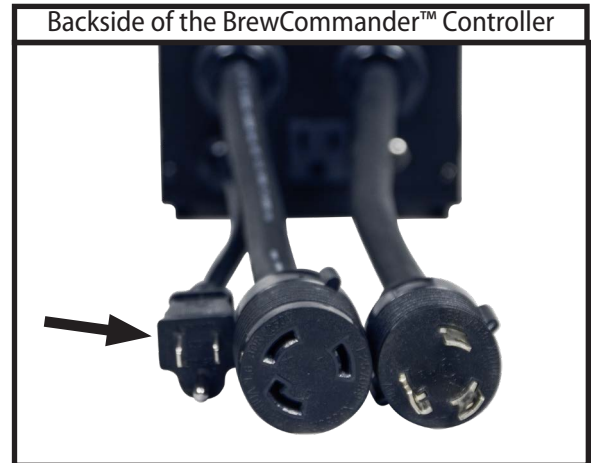

Attach the three way valve to each outlet of the RipTide™ pumps with PTFE tape. (Figure AC)

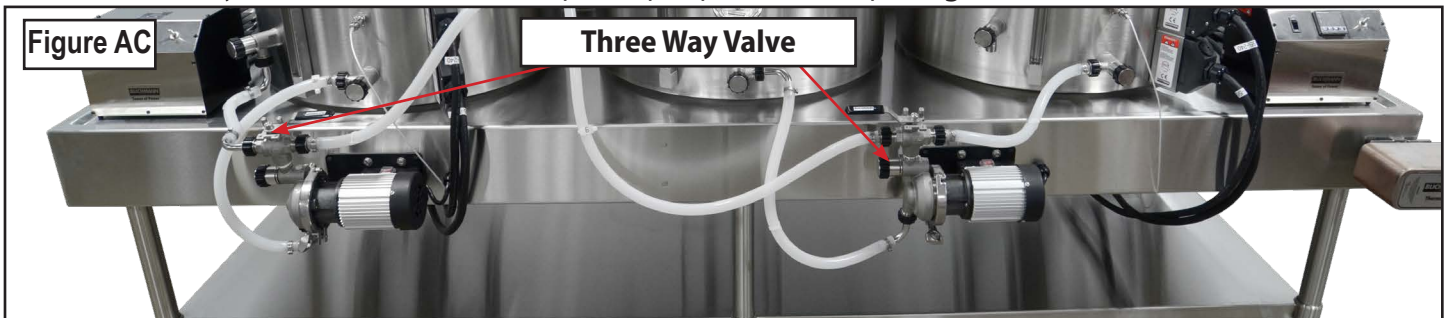

Flow Meter

Attach the elbow to the AutoSparge™ output with PTFE tape. Refer to the AutoSparge™ manual for installation instructions. Attach the Flow Meter to the elbow with PTFE tape.

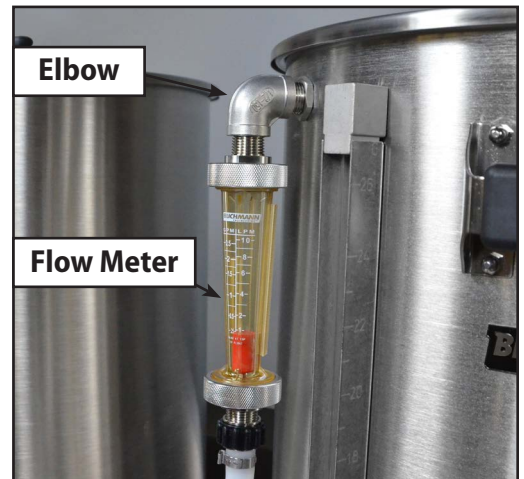

Thread Sealing Tape

Use thread tape on all male threads except when using QuickConnects™.

HERMS SYSTEM ONLY

Attach the Tee Fitting on your HERMS system to the bottom of the HERMS coil with PTFE Tape. Attach the hex nipples to the ends of the Tee Fitting using PTFE tape. **(Figure AB)**



RIMS SYSTEM ONLY

Installing the RIMS-Rocket™

Mount the RIMS-Rocket™ with the HopRocket™ Mounting Bracket. Use the 5/16 hardware to secure the mounting bracket to the table. **(Figure 1a)**

NOTE: The Mounting Bracket will come with a t-slot plate that is used for the TopTier stand. This will not be needed for the Pilot System.

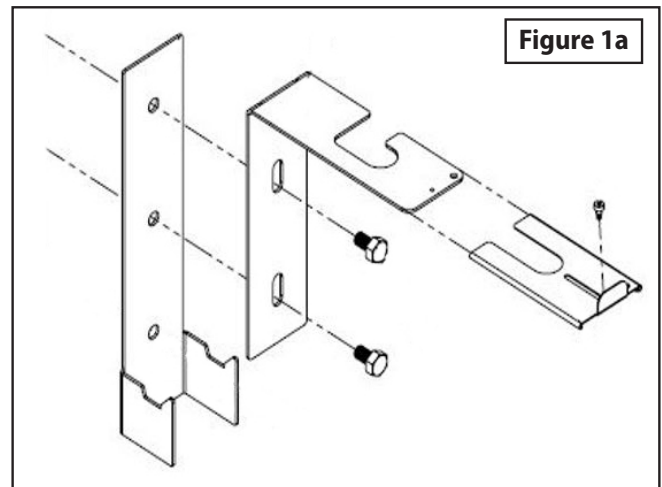

Attach the temperature sensor to the top of the RIMS-Rocket™ with PTFE tape. Attach the Tee Fitting to the front of the RIMS-Rocket™ with PTFE tape. **(Figure 1b)** Attach the Hex Nipples to the ends of the Tee Fitting.

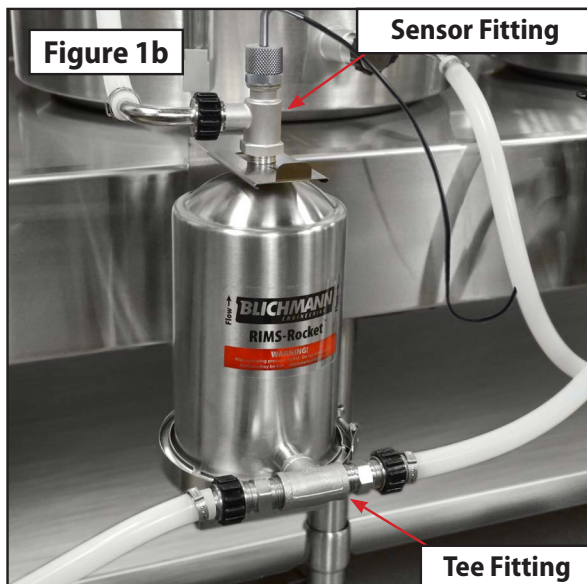

Attach the 3 way valve to the right RipTide outlet with PTFE tape on a RIMS System. **(Figure 1c)**

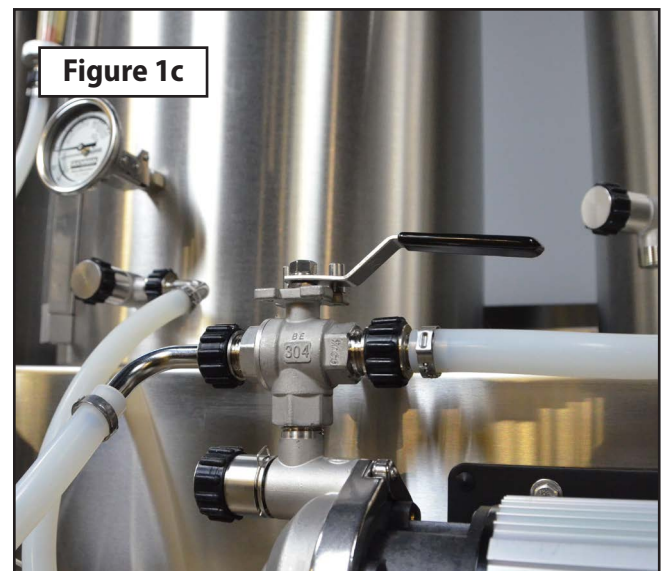

Installing the Therminator™

Mount the Quick Release plate to the table using the hardware provided. (Figure 2)



Installing the BrewCommander™

There will be 1 or 2 cable pass-through holes in the back of the table to run the controller cords through. If you are using the Dual Element Controller it is possible for all four cables to fit through a single grommet.

Step 1: Remove Grommet.

Step 2: One cable at a time, route cables through the table and grommet.

Step 3: Re-install grommet into table. (See images below.)

Step 4: Plug the 115V extension cable(s) into the outlet under the table. Plug the BrewCommander™ into the extension cord.

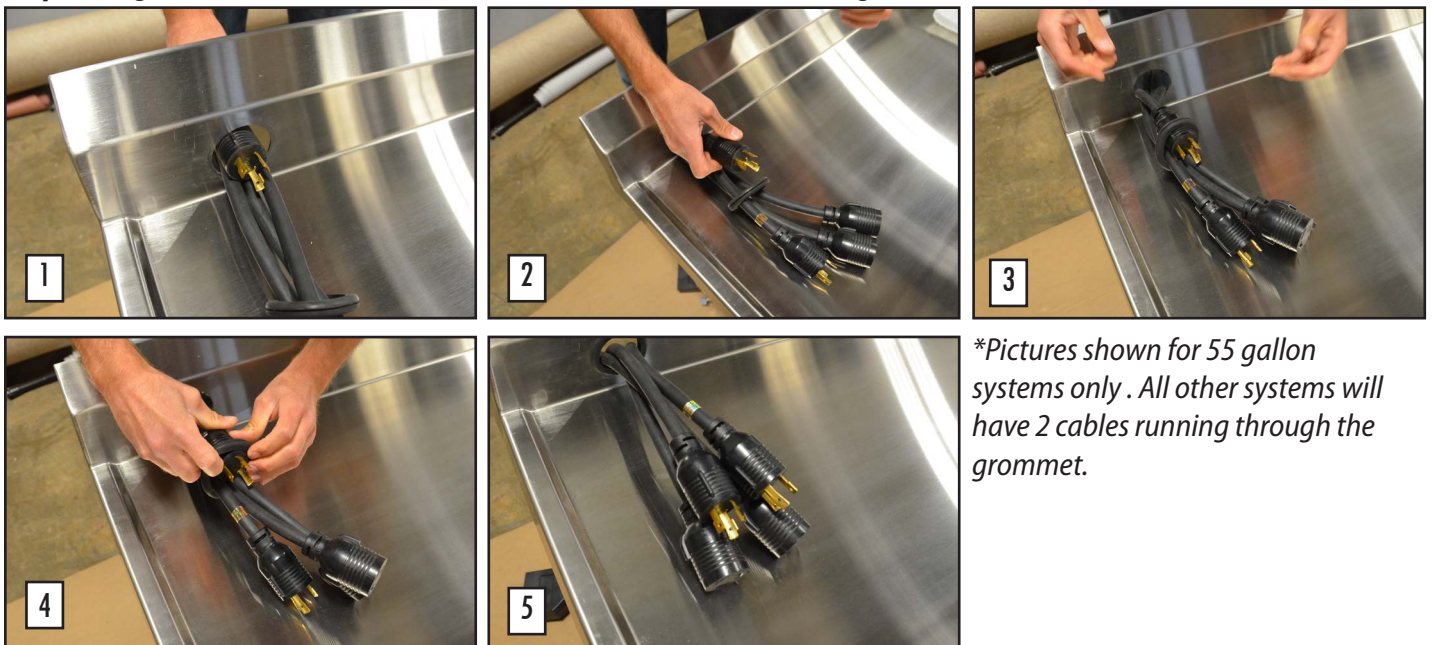

**Pictures shown for 55 gallon systems only . All other systems will have 2 cables running through the grommet.*

Cord Management

Your parts kit will contain adhesive Velcro straps. Use the small straps underneath the table to hold the RipTide™ pump wires. Use the large Velcro straps to mount to the back of the table. Your table will have 3 or 5 studs on the back to mount your large Velcro straps to. Attach the large Velcro straps to the back of the table with the adhesive and use the acorn nut to lock them in place. This will add extra reinforcement to the straps. The stud in the center of the table is for the RipTide™ cord and the 2 studs closest to the cable hole and grommet is for the BoilCoil™ cables. (Figure 3)

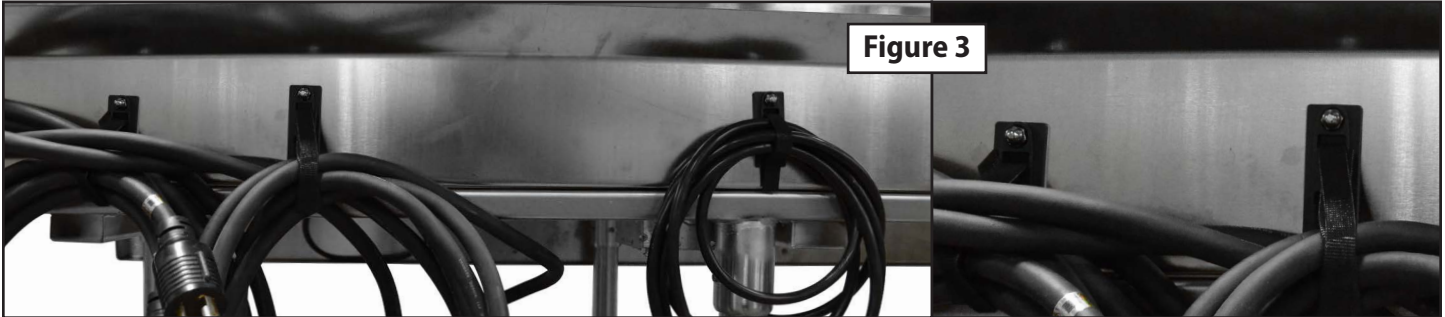

Installing Hose

Familiarize yourself with the function of the brewhouse. Attach QuickConnectors where needed. Your kit will come with 20 feet of hose. Attach the hose to the QuickConnectors, stretch to the desired length, and cut. Once you are satisfied with the length and location of the hoses, crimp the hoses with a crimping tool. (Figure 4)

(Figure 4)

Your parts kit will come with zip ties to label your hose.

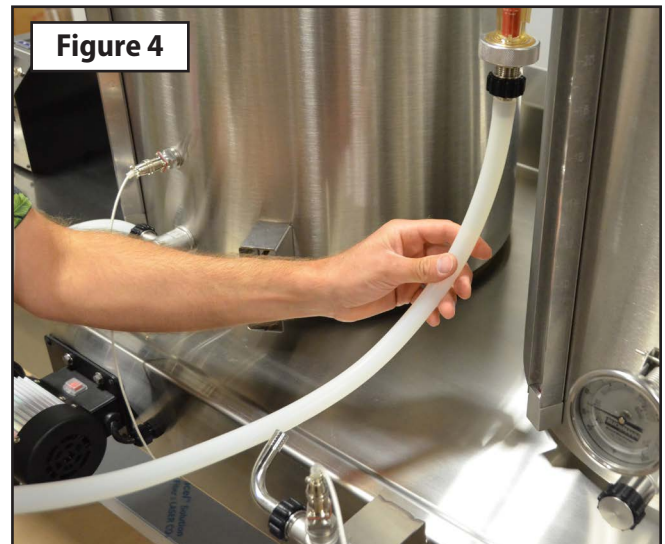

AutoSparge™ Upgrade Kit

The AutoSparge™ will come with a kit to use for 30 gallon and 55 gallon kettles. This will include a longer stem and hose, as well as an extra float ball. (Figure 5)

**For systems using smaller kettles use what is provided in the AutoSparge™ box. It will have the correct hose length, ball, and stem.*



Assembling Your System

There are different system configurations we offer. Use the diagram that best suits your needs.

3 Vessel RIMS System (5 gal - 20 gal)



**20 Gallon System Shown*

Refer to all manuals of each individual component for assembly and operation.

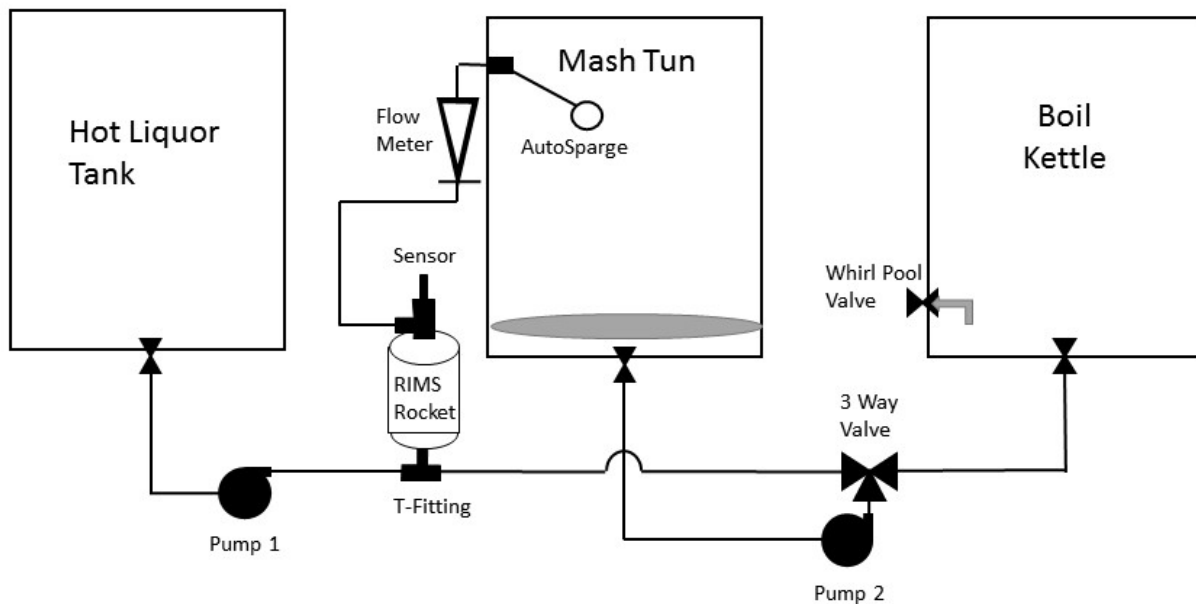

Step 1: Heat Brewing Water

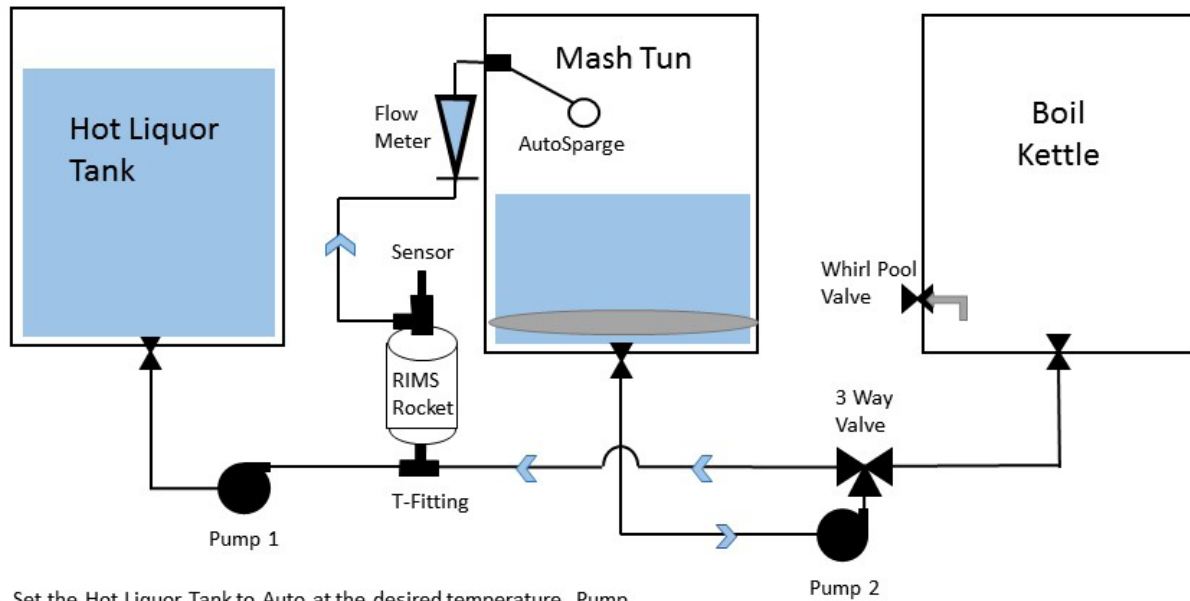

1. Set the Hot Liquor Tank to Auto at the desired temperature. Pump 1 is set to off.
2. Set Pump 2 to on with the three way valve set to recirculate.
3. Set the RIMS Rocket to Auto at the desired strike water temperature.

Step 2: Add Grain and Recirculate

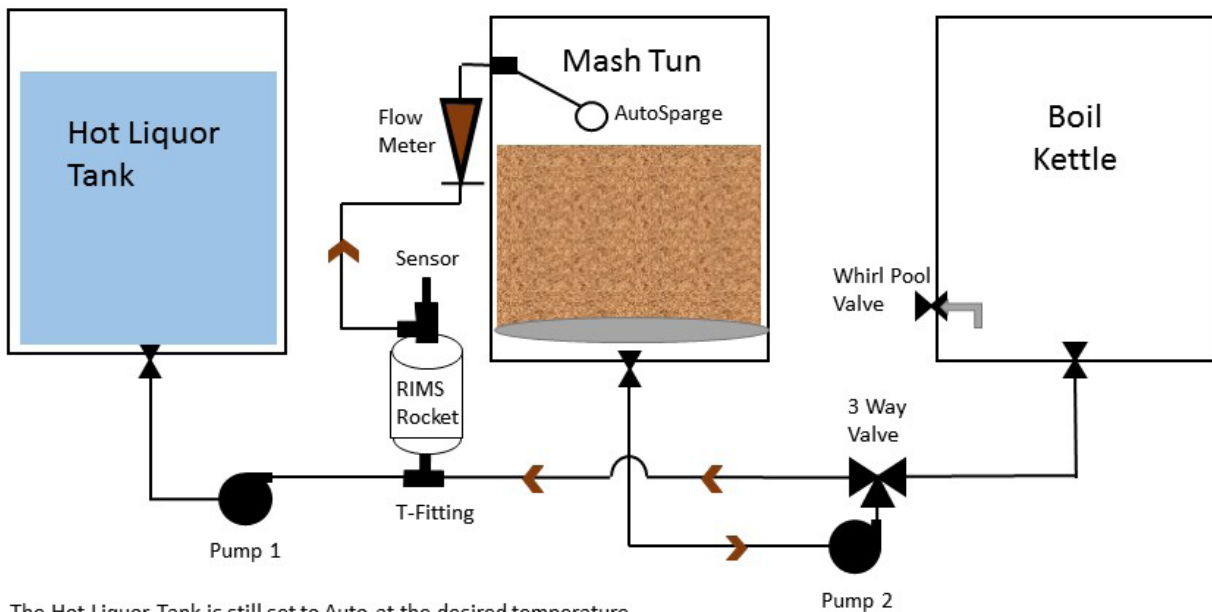

1. The Hot Liquor Tank is still set to Auto at the desired temperature. Pump 1 remains off.
2. Set RIMS Rocket to Reset or OFF
3. Set Pump 2 to off and add the grain to the Mash Tun (Dough in)
4. Stir well and let the grain set for 10 minutes before setting Pump 2 to on. Set the appropriate flow rate.
5. Set the RIMS Rocket at the desired Mash temperature and perform step mashing techniques as desired. Always set heat to off before setting Pump 2 to off.

Step 3: Sparge

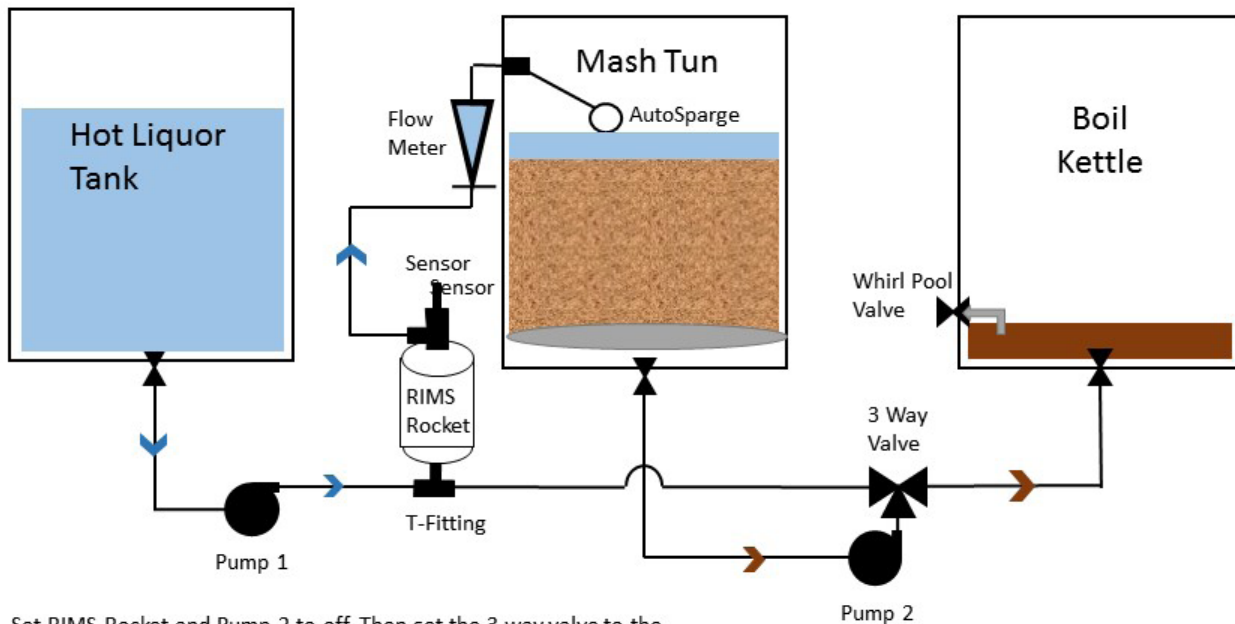

1. Set RIMS Rocket and Pump 2 to off. Then set the 3 way valve to the Boil Kettle.
2. Set the appropriate level with the AutoSparge and set Pump 1 to on. Adjust the flow to the desired flow rate. In this configuration, the flow rate shown on the flow meter will be determined by the valve on Pump 2.

4. Boil and Whirlpool

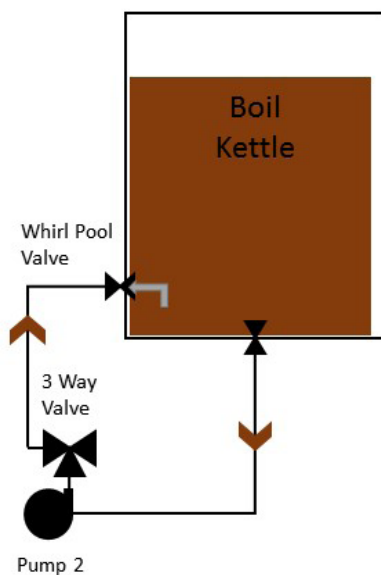

1. Boil the wort and add desired ingredients
2. Connect hoses as shown for Whirlpool and recirculate as desired.

5. Chill Wort and Transfer

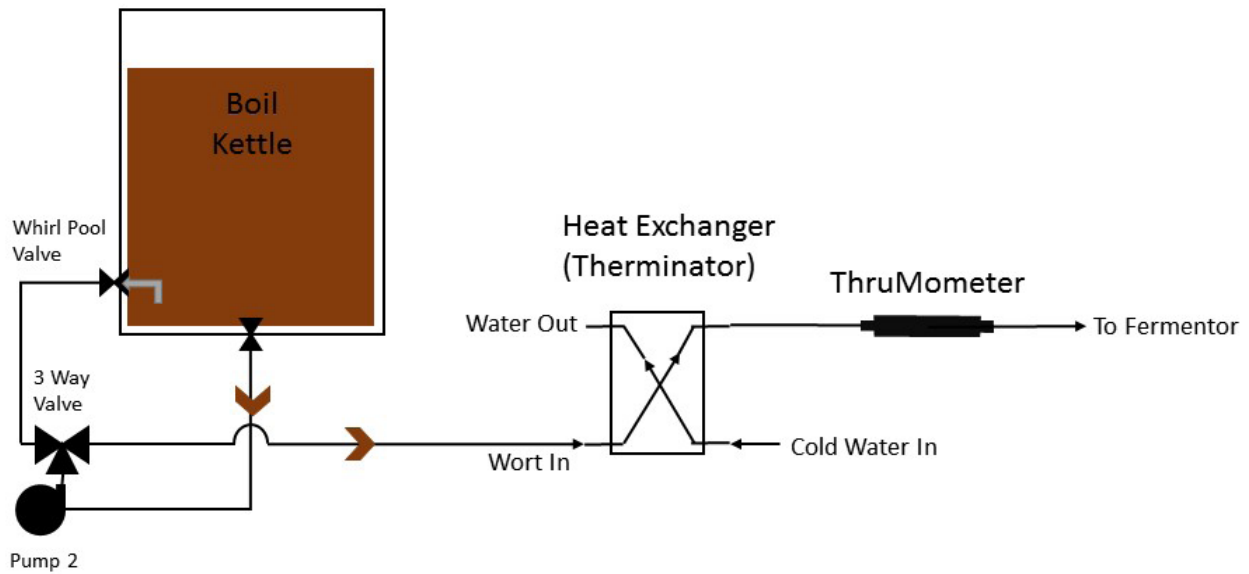

1. Connect hose as show for chilling.
2. Turn on cold water supply and begin pumping wort through the heat exchanger.
3. Monitor the temperature on the ThruMometer and adjust flow as required. Decrease wort flow to lower the temperature or decrease water flow to increase the temperature.

Horizontal BrewEasy™ (20 gal - 1 BBL)



**1 BBL System Shown*

Plumbing and Hardware Schematic:
2 Vessel, BrewEasy

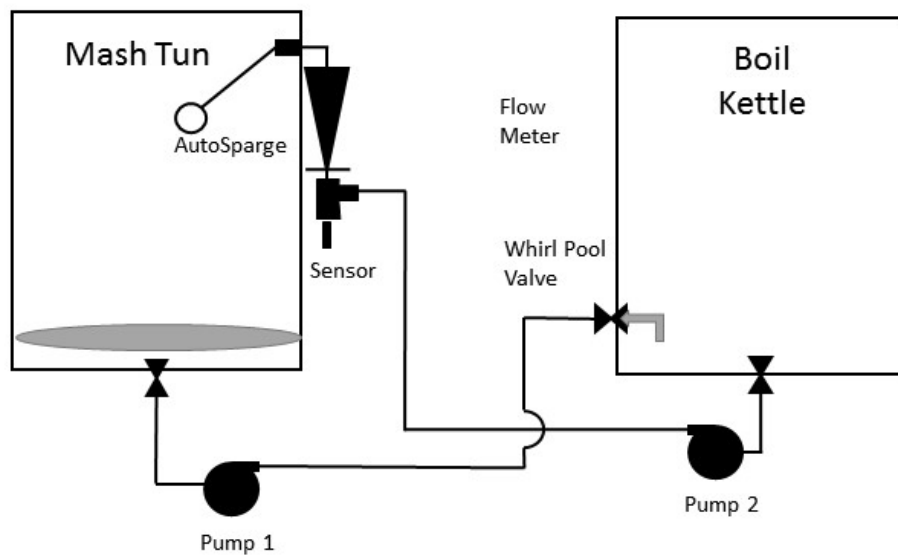

Step One: Heat Brewing Water

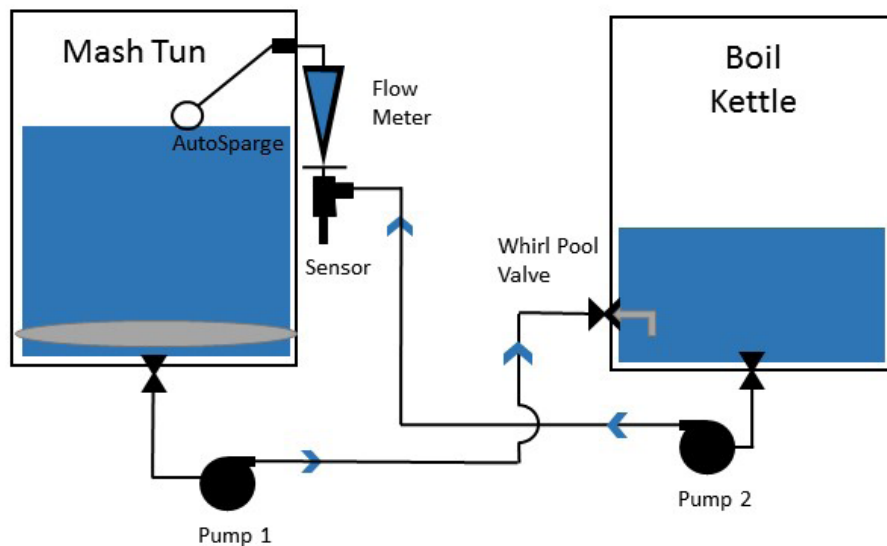

1. Set the Controller to Auto at the desired temperature.
2. Adjust AutoSparge to the appropriate level. Pump 2 is set to on.
3. Set Pump 1 to on. Ensure the BoilCoils are completely covered while heating

Step Two: Add Grain and Recirculate

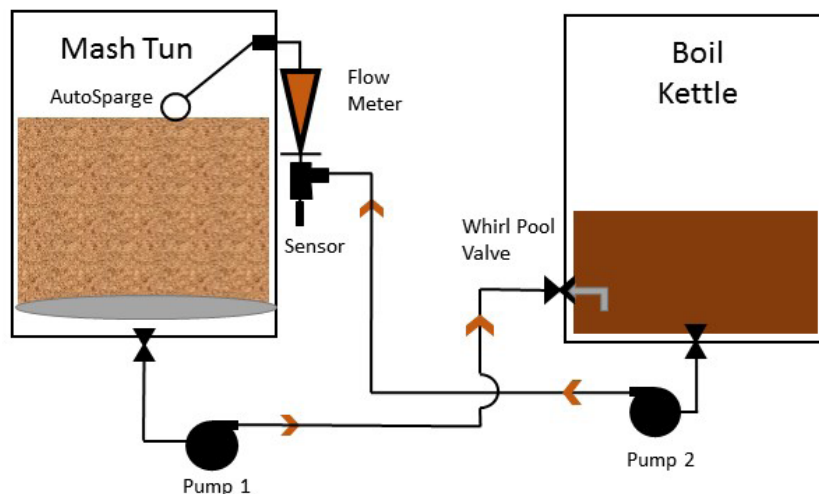

1. Set controller to Reset or OFF
2. Set Pump 1 and Pump 2 to off, close the valve on Pump 1, and add the grain to the Mash Tun (Dough in)
3. Stir well and let the grain set for 10 minutes before setting Pump 2 to on. Adjust the AutoSparge as required, set Pump 1 to on, and adjust the flow rate of the system with the valve located on Pump 1.
4. Set the controller to the desired Mash temperature and perform step mashing techniques as desired. Always set heat to off before setting Pump 1 or Pump 2 to off.

Step Three: Sparge

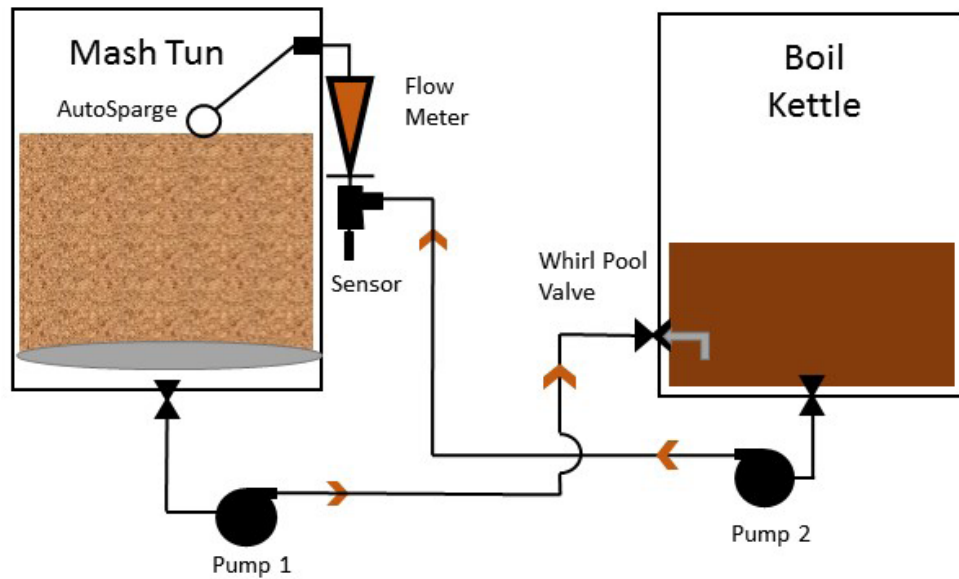

1. Close the valve located on Pump 2 and set the pump to off.
2. Set the Controller to On.
3. Pump all of the wort from the Mash Tun into the Boil Kettle.
4. Boil the Wort as required

Step Four: Boil and WhirlPool

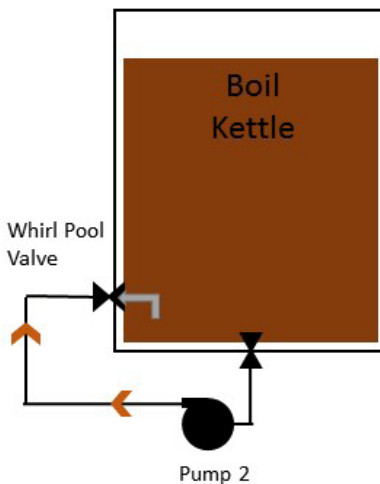

1. Close all the valves and re-configure the hoses as shown.
2. WhirlPool as desired.

Step Five: Chill Wort and Transfer

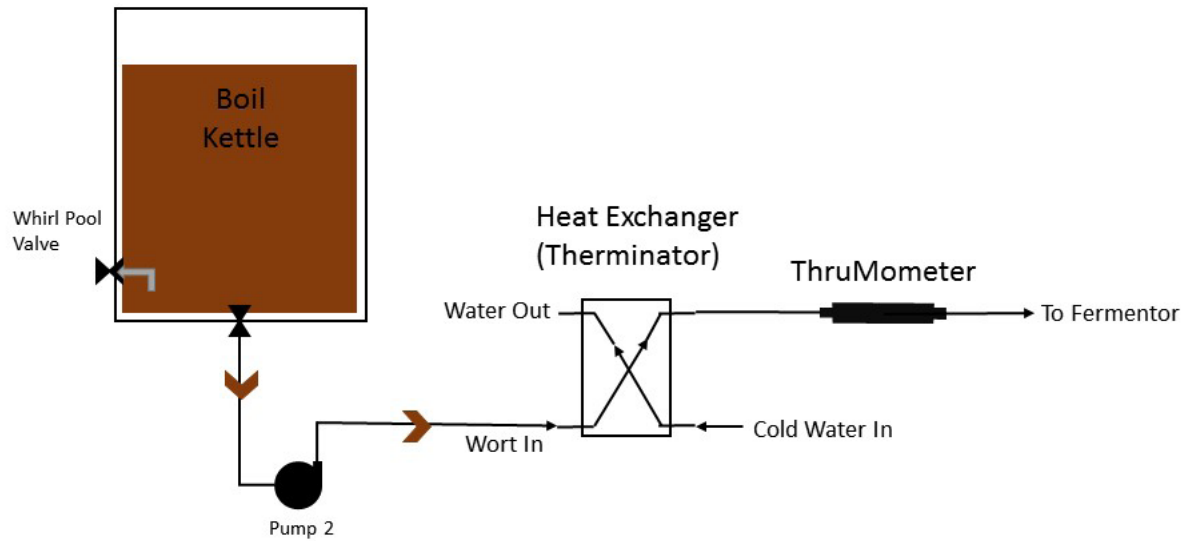

1. Connect hose as show for chilling.
2. Turn on cold water supply and begin pumping wort through the heat exchanger.
3. Monitor the temperature on the ThruMometer and adjust flow as required. Decrease wort flow to lower the temperature or decrease water flow to increase the wort temperature.

3 Vessel HERMS System (5 gal - 1 BBL)



*1 BBL System Shown

Plumbing and Hardware Schematic:
3 Vessel, Electric HERMS

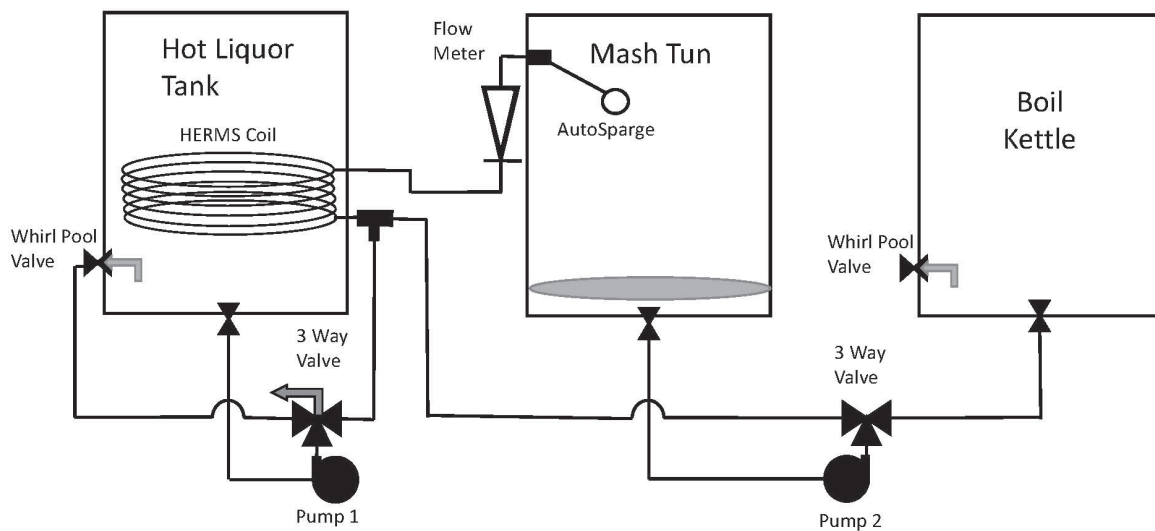

1. Connect hoses as shown.

T-Fitting

Step 1: Heat Brewing Liquor

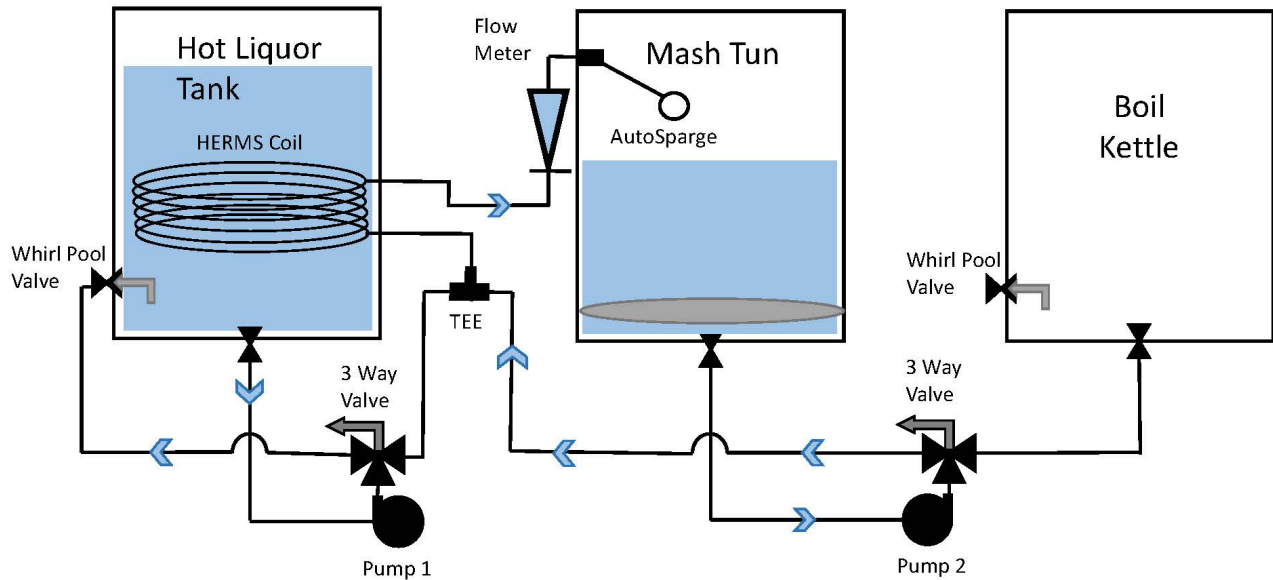

1. Set the Hot Liquor Tank to Auto at about 5 degrees above the desired strike water temperature.
2. Set both pumps to ON and direct the flow as shown for dual recirculation.
3. The Left controller will maintain the HLT Temperature, and the mash temperature will remain steady at a few degrees below the HLT. This temperature offset will vary on system size, flow rate and other factors. Document this offset for future use.

© Blichmann Engineering 2019
Flow Diagram, 3 Vessel, HERMS V5, 3/25/19

Step 2: Add Grain and Recirculate

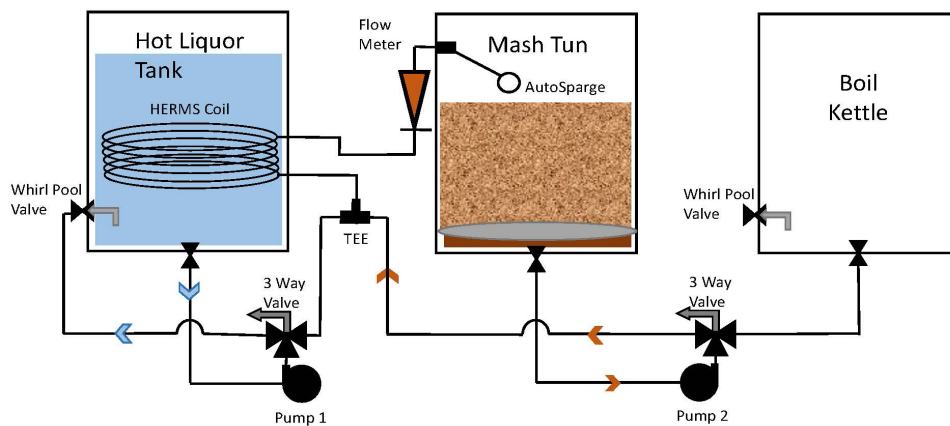

1. Once the strike water is at the desired temp, set Pump 2 to OFF and add the grain to the Mash Tun. (Dough in)
2. Turn off the Hot Liquor Tank, continue to recirculate with Pump 1. Allow the Hot Liquor Tank to cool to about 5 degrees above the desired Mash Temperature.
3. Set HLT controller Auto to about 5 degrees above the desired Mash Temperature
4. After 10 minutes of rest, set Pump 2 to ON and adjust the valve to set the appropriate flow rate
5. Perform desired step mashing techniques as required. Determine the correct temperature offset to achieve favorable mash temperature and heating times.

© Blichmann Engineering 2019
Flow Diagram, 3 Vessel, HERMS V5, 3/25/19

Step 3: Sparge

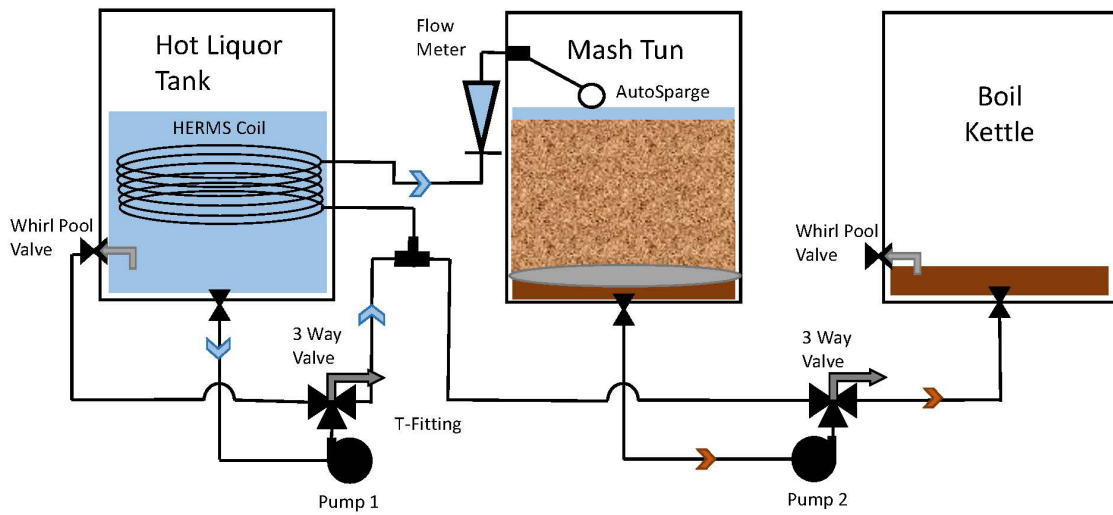

1. Turn the valve on Pump 2 towards the Boil Kettle.
2. Redirect the flow of Pump 1 to the Right and set the appropriate level on the AutoSparge.
3. Set the Hot Liquor Tank Teamp controller to off when the level falls to the temperature probe.
4. Set the Boil Kettle controller to Manual and 100% power after the BoilCoil is completely submerged in wort.

© Blichmann Engineering 2019
Flow Diagram, 3 Vessel, HERMS V5, 3/25/19

Step 4. Boil and Whirlpool

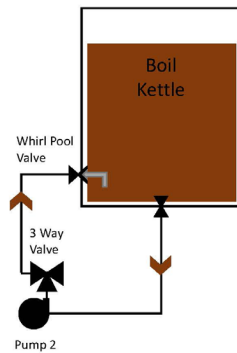

1. Boil the wort and add desired ingredients
2. Connect hoses as shown for Whirlpool and recirculate as desired.

© Blichmann Engineering 2019
Flow Diagram, 3 Vessel, HERMS V5, 3/25/19

Step 5. Chill Wort and Transfer

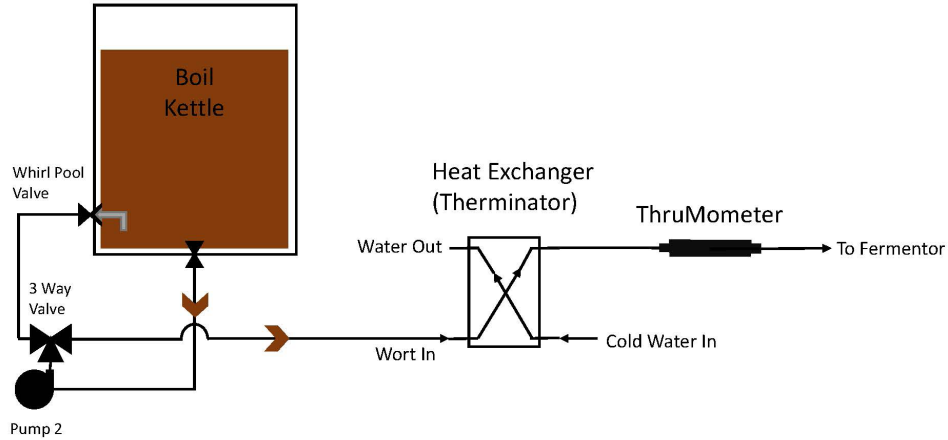

1. Connect hose as shown for chilling.
2. Turn on cold water supply and begin pumping wort through the heat exchanger.
3. Monitor the temperature on the ThruMometer and adjust flow as required. Decrease wort flow to lower the temperature or decrease water flow to increase the temperature.

© Blichmann Engineering 2019
Flow Diagram, 3 Vessel, HERMS V5, 3/25/19

Blichmann Engineering Product Warranty

A. Limited Warranty

1. Blichmann Engineering warrants to the original purchaser that this product will be free from manufacturing defects in material and workmanship for a period of one (1) year from the date of purchase by the customer. Proof of purchase is required. Blichmann Engineering's obligation to repair or replace defective materials or workmanship is the sole obligation of Blichmann Engineering under this limited warranty.
2. The limited warranty covers only those defects that arise as a result of normal use of the product and does not cover any other problems, including, but not limited to, those that arise as a result of:
 - a. *Improper maintenance or modification;*
 - b. *Damage due to incorrect voltage or improper wiring by customer;*
 - c. *Operation outside of the product's specifications;*
 - d. *Carelessness or neglect to operate the product in accordance with instructions provided with the product;*
 - e. *Damaging the tamper label on the product;*
 - f. *Damage by over-tightening the fasteners;*
 - g. *Failure to follow cleaning and / or maintenance procedures; or*
 - h. *Exceeding published operational temperatures.*
3. Blichmann Engineering reserves the right to request delivery of the defective component for inspection before processing the warranty claim. If Blichmann Engineering receives, during the applicable warranty period, notice of a defect in any component that is covered by the warranty, Blichmann Engineering shall either repair or replace the defective component with a new or rebuilt component at Blichmann Engineering's option.
4. Blichmann Engineering must be notified within seven (7) days of the delivery date of any shipping damage. Customer is responsible for shipping damage outside of this time period. Approval for return must be provided by Blichmann Engineering prior to any return. Customer is responsible for keeping all original packaging material for warranty returns. Blichmann Engineering is not responsible for damage from improperly packaged warranty returns, and these repair costs will be the sole responsibility of the customer. Shipping costs for warranty returns are covered only for the contiguous United States.
5. Blichmann Engineering's limited warranty is valid in any country where the product is distributed.

B. Limitations of Warranty

1. Any implied warranty that is found to arise by way of state or federal law, including any implied warranty of merchantability or any implied warranty of fitness, is limited in duration to the terms of this limited warranty and is limited in scope of coverage to this warranty. Blichmann Engineering disclaims any express or implied warranty, including any implied warranty of fitness for a particular purpose or merchantability, on items excluded from coverage as set forth in this limited warranty.
2. Blichmann Engineering makes no warranty of any nature beyond that contained in this limited warranty. No one has authority to enlarge, amend, or modify this limited warranty, and Blichmann Engineering does not authorize anyone to create any other obligation for it regarding this product.
3. Blichmann Engineering is not responsible for any representation, promise, or warranty made by any independent dealer or other person beyond what is expressly stated in this limited warranty. Any selling or servicing dealer is not Blichmann Engineering's agent, but an independent entity.

C. Limitations of Liability

1. The remedies provided in this warranty are the customer's sole and exclusive remedies.
2. Except for the obligations specifically set forth in this warranty, in no event shall Blichmann Engineering be liable for direct, indirect, special, incidental, or consequential damages, whether based on contract, tort, or any other legal theory and whether or not advised of the possibility of such damages.
3. This warranty does not cover, and in no event shall Blichmann Engineering be liable for, travel, lodging, or any other expense incurred due to manufacturing defects in material and workmanship, or any other reason.
4. Any performance of repairs after the warranty coverage period has expired or performance of repairs regarding anything excluded from coverage after this limited warranty shall be considered good-will repairs and they will not alter the terms of this limited warranty, or extend any warranty coverage period.
5. Venue for any legal proceedings relating to or arising out of this warranty shall be in Tippecanoe County, Indiana, United States, which courts will have exclusive jurisdiction.

D. Local Law

1. This warranty gives the customer specific legal rights. The customer may also have other rights that vary from state to state in the United States or other countries.
2. To the extent that this warranty is inconsistent with local law, it shall be deemed modified, only to the extent necessary to be consistent with such local law.