

90 min.

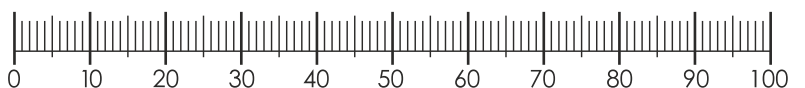

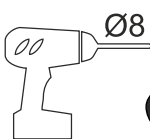

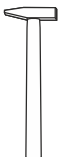
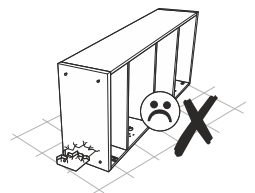
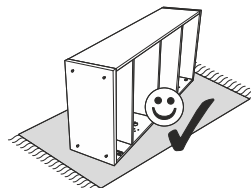
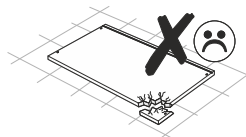
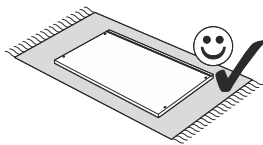
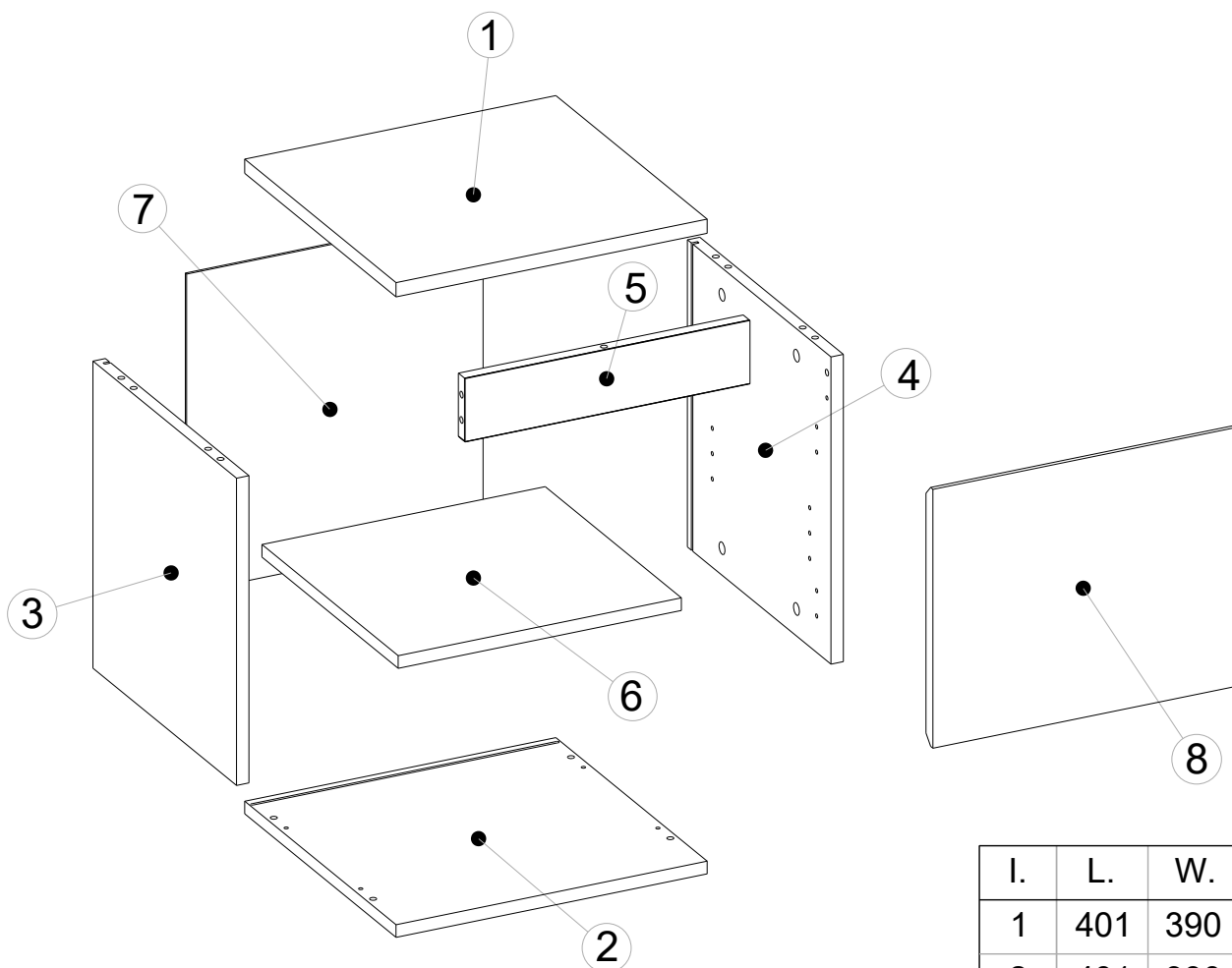

ZLAD NIGHT STAND

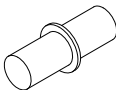
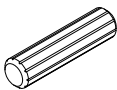
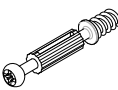

I.	L.	W.	QTY.
1	401	390	1
2	401	390	1
3	388	370	1
4	388	370	1
5	367	80	1
6	365	351	1
7	403	382	1
8	395	327	1

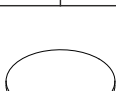
BAG 1

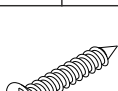
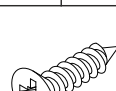
PP x4 	K x10 	T x11 	M x11 
Z x11 	SP x6 	W2 x6  3x18	W1 x20  4x16

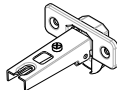
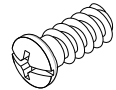
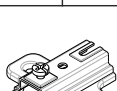

BAG 2

ZR x2 	WE x4  6,3x13
ZP x2 	

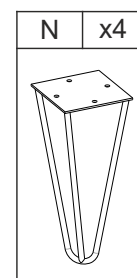
BAG 3

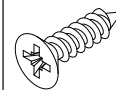
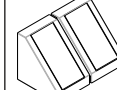
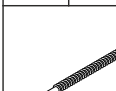

BAG 4

W1 x2  4x16	LK x1 
W3 x1  4x70	KR x1 

1

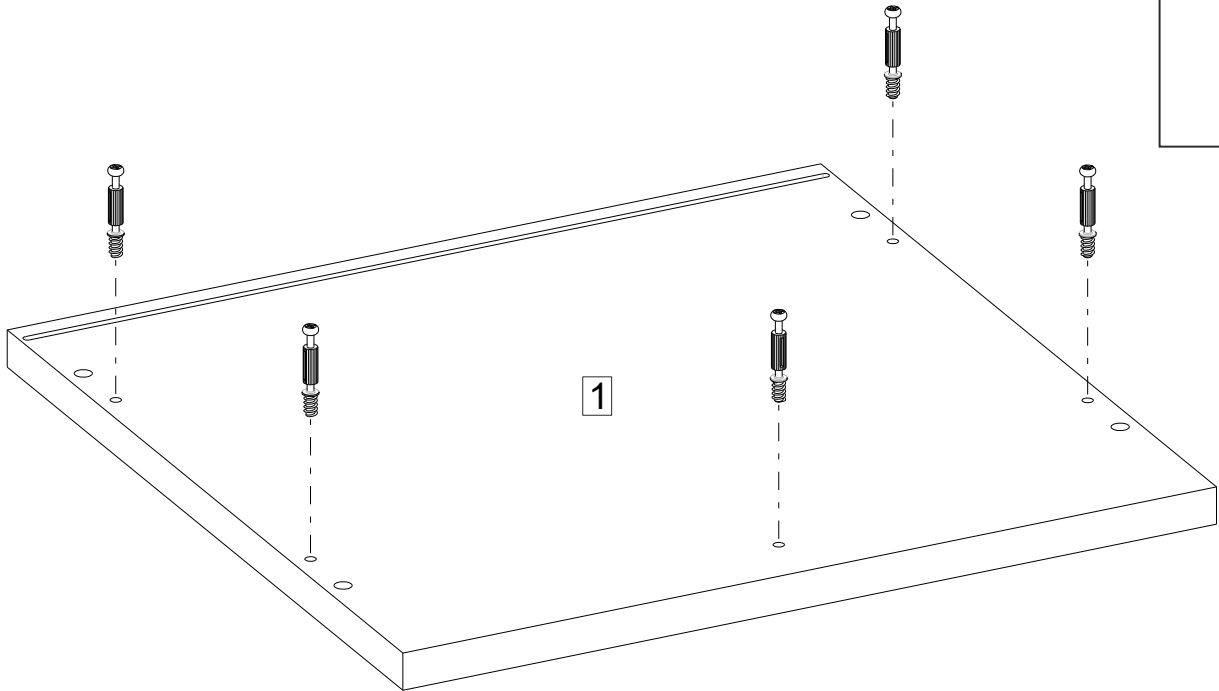
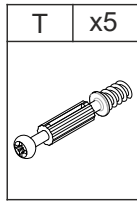
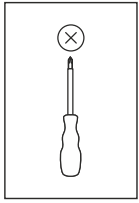

2

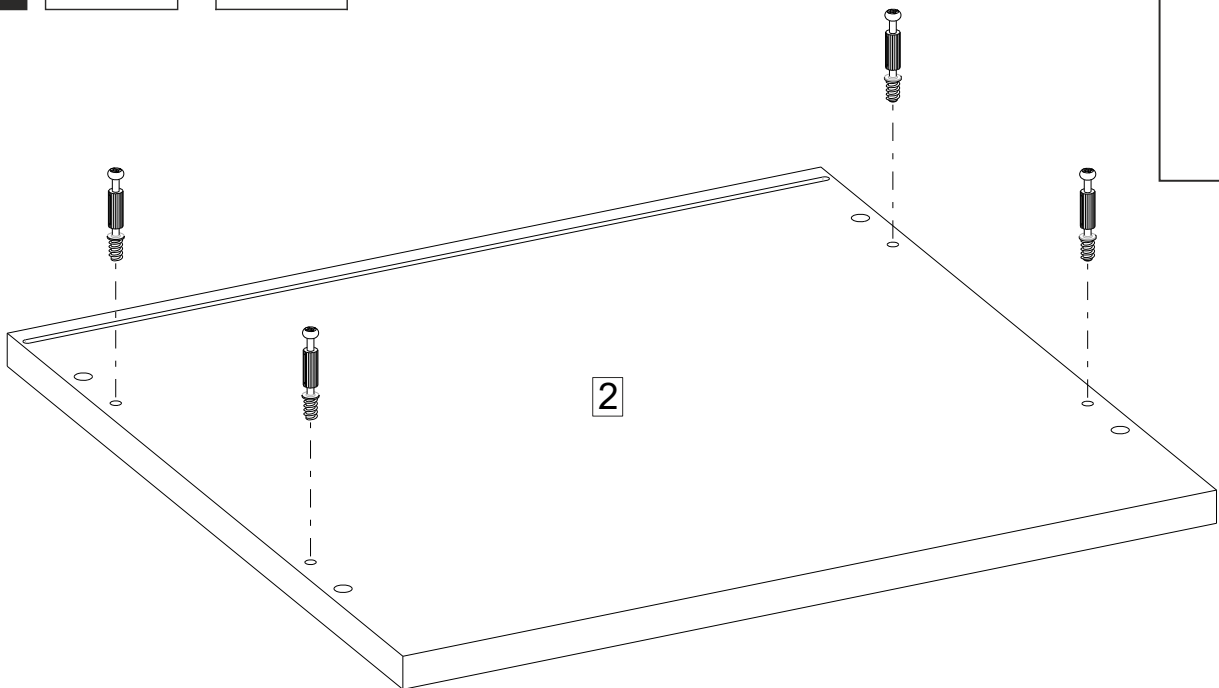
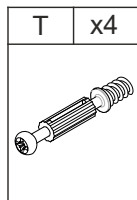
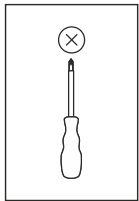

3R

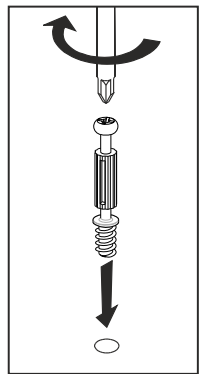
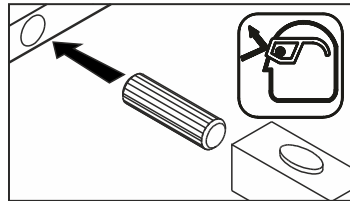
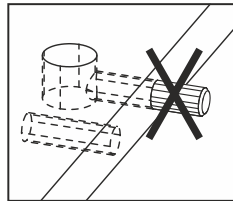
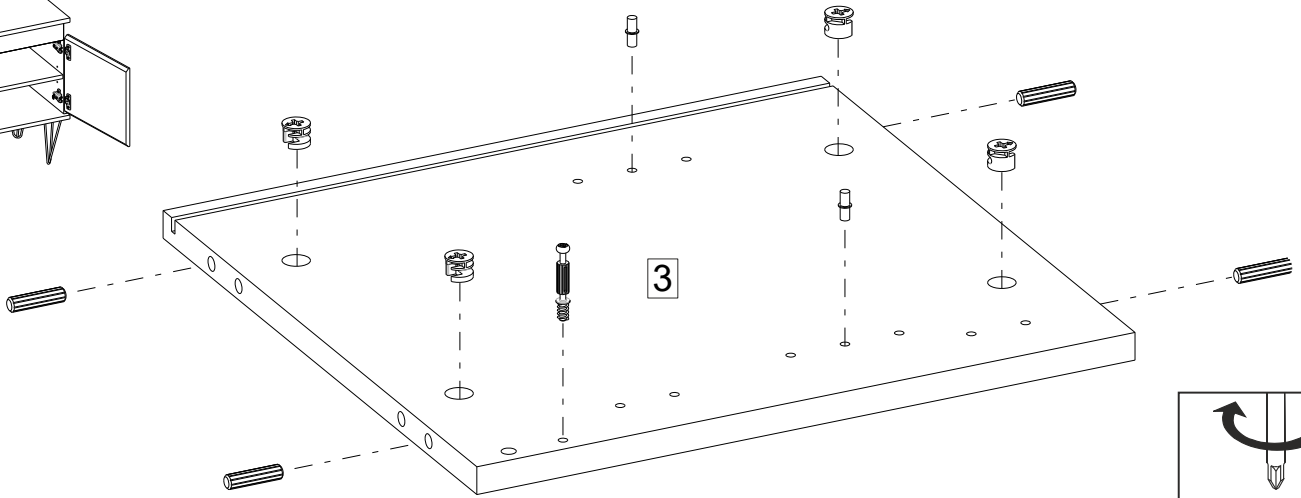
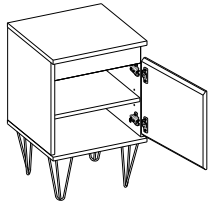
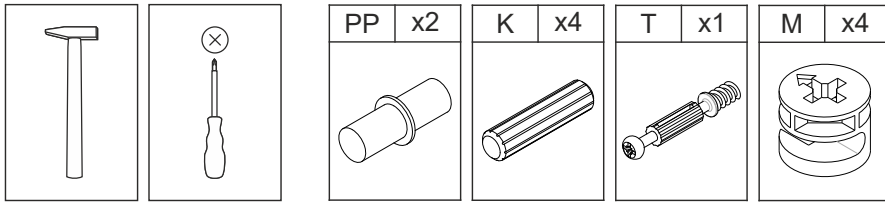

4R

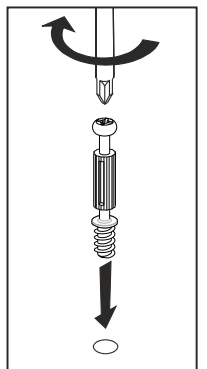
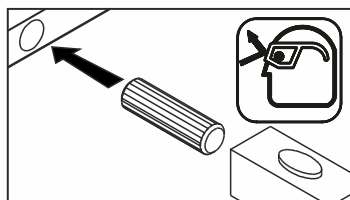
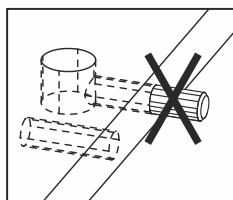
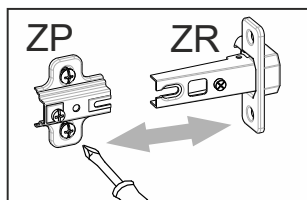
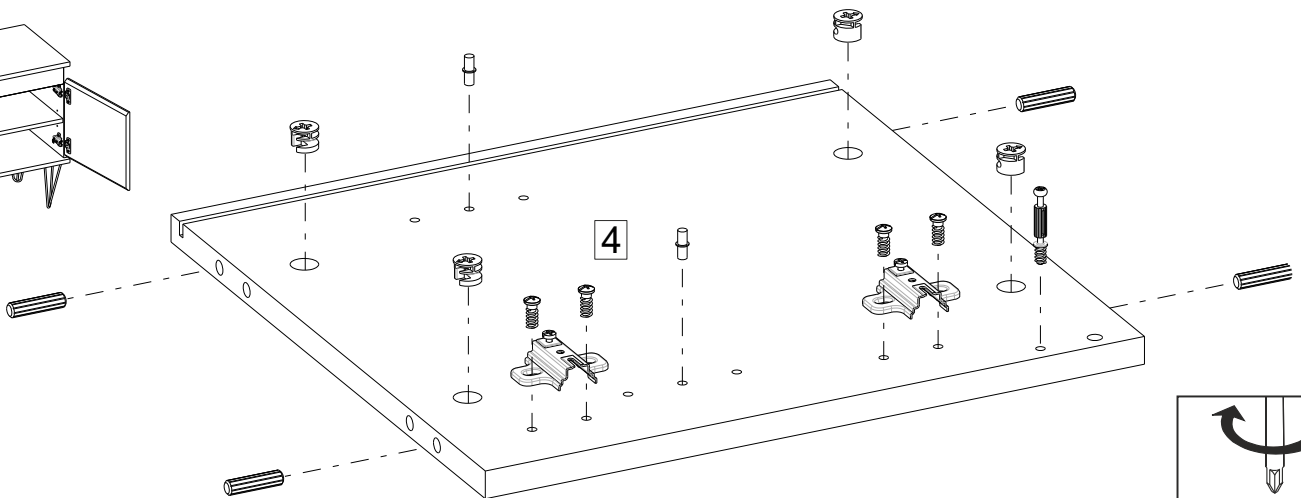
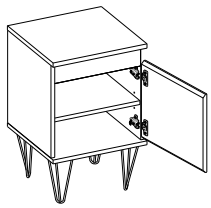
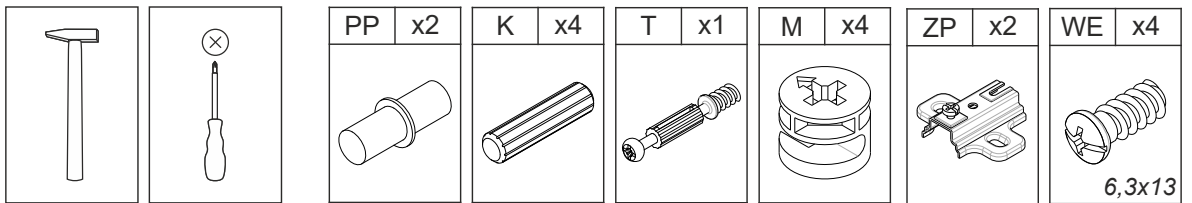

3

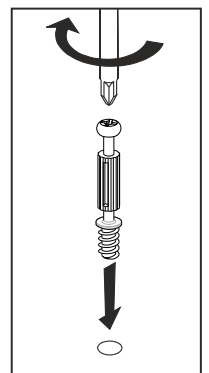
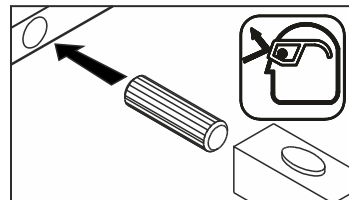
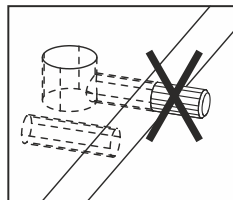
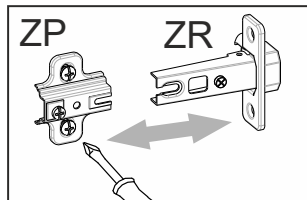
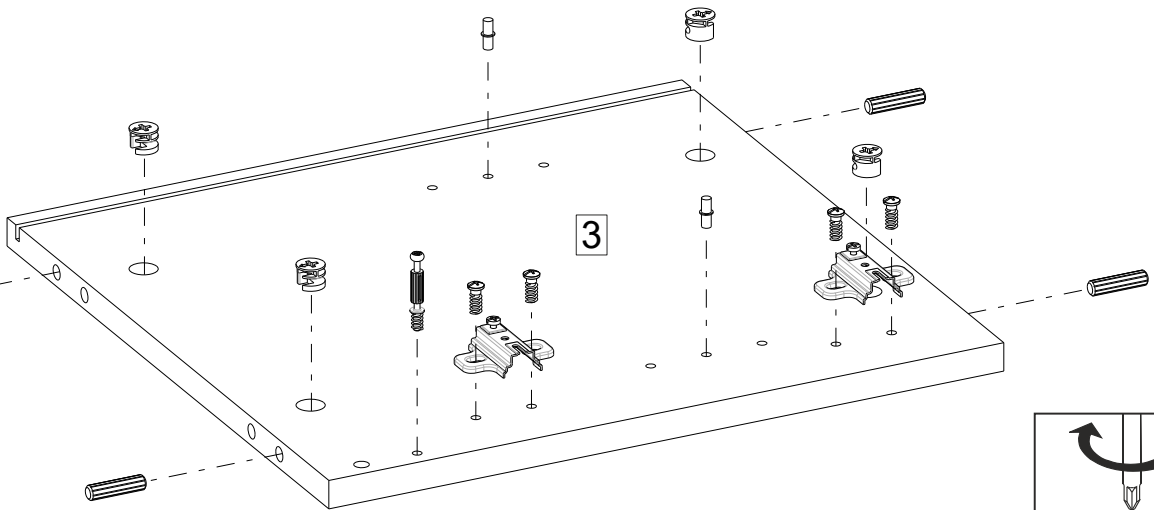
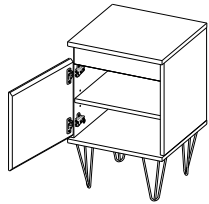
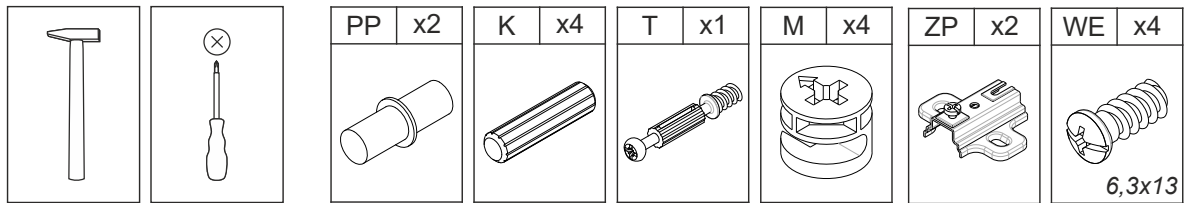

4

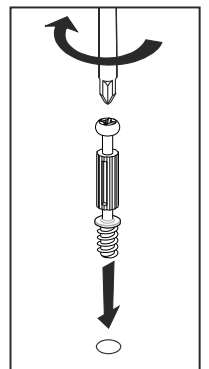
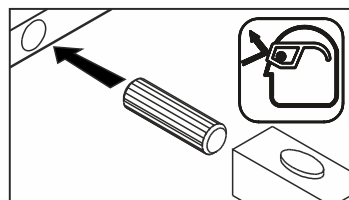
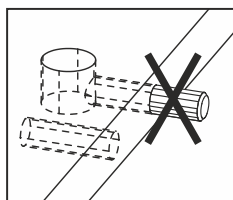
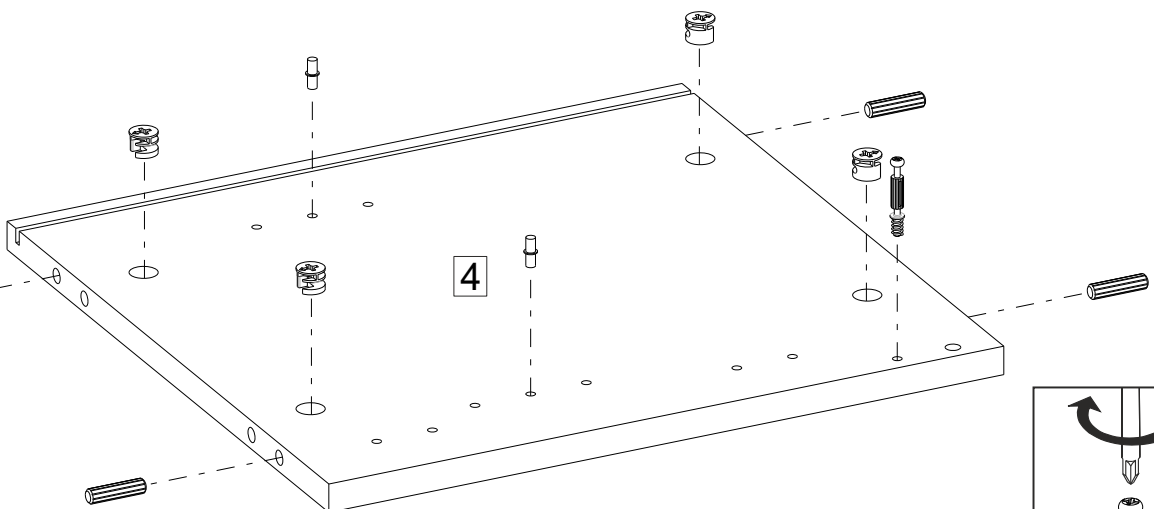
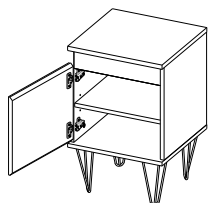
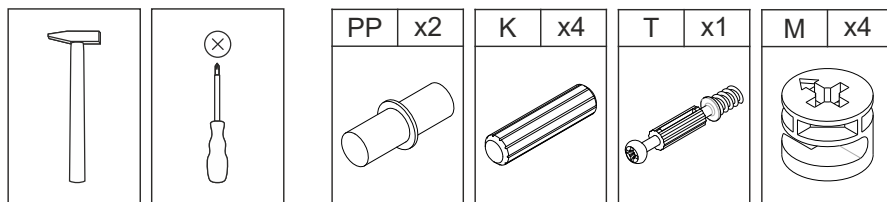

5

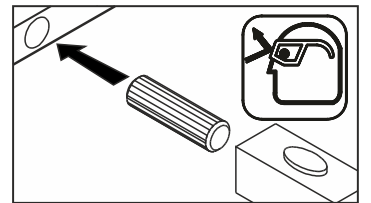
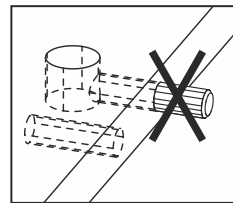
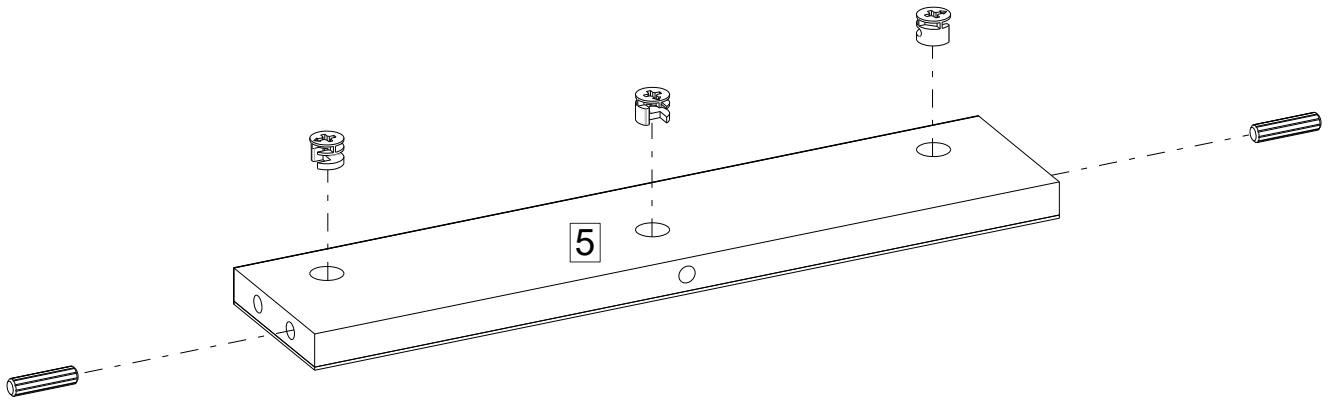
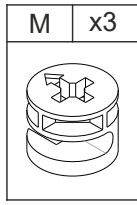
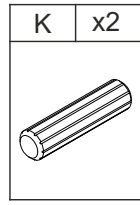
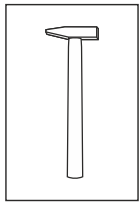

6

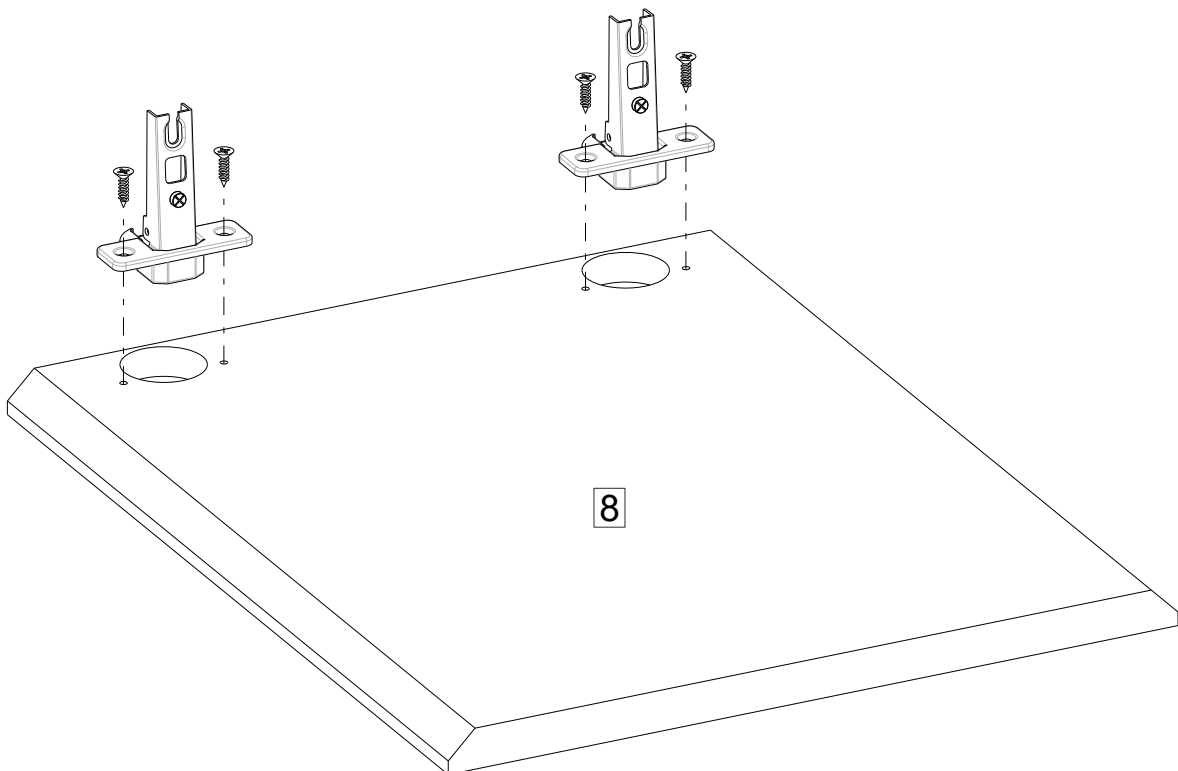
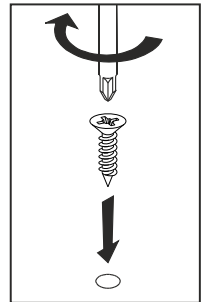
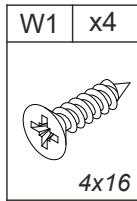
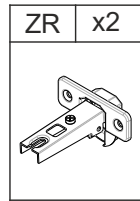
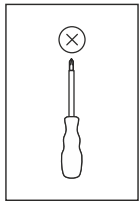

7

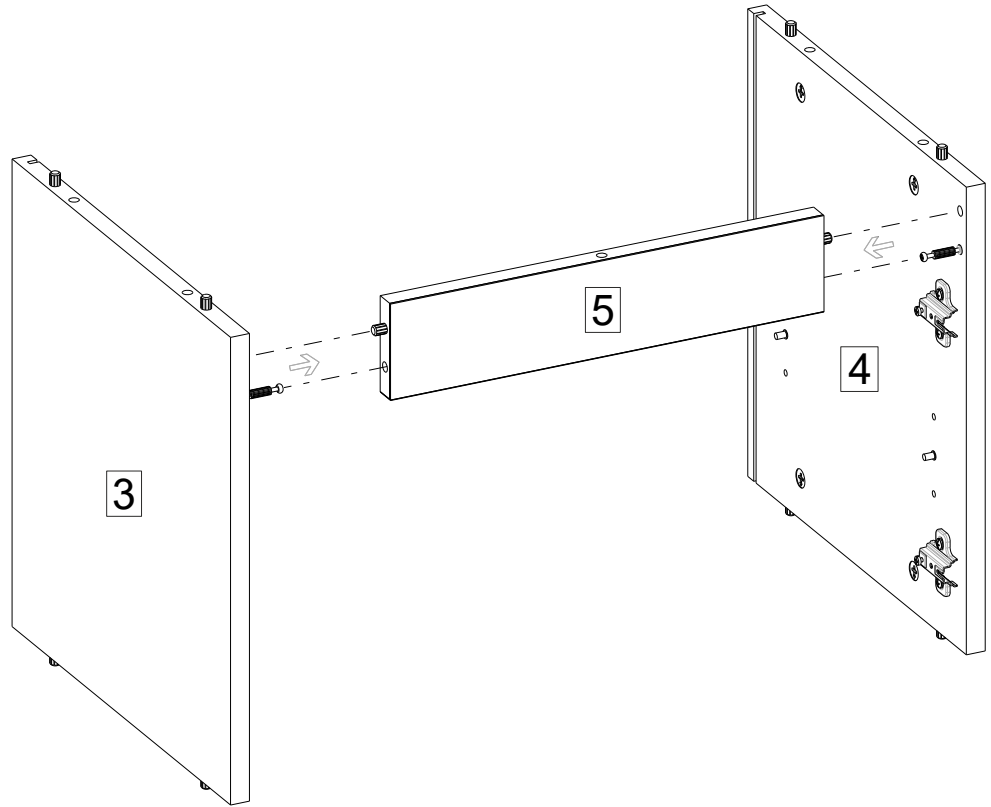
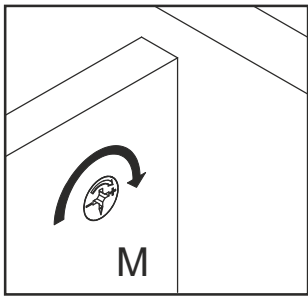
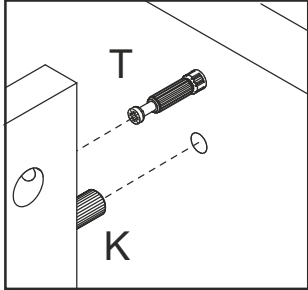
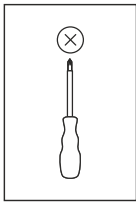

8

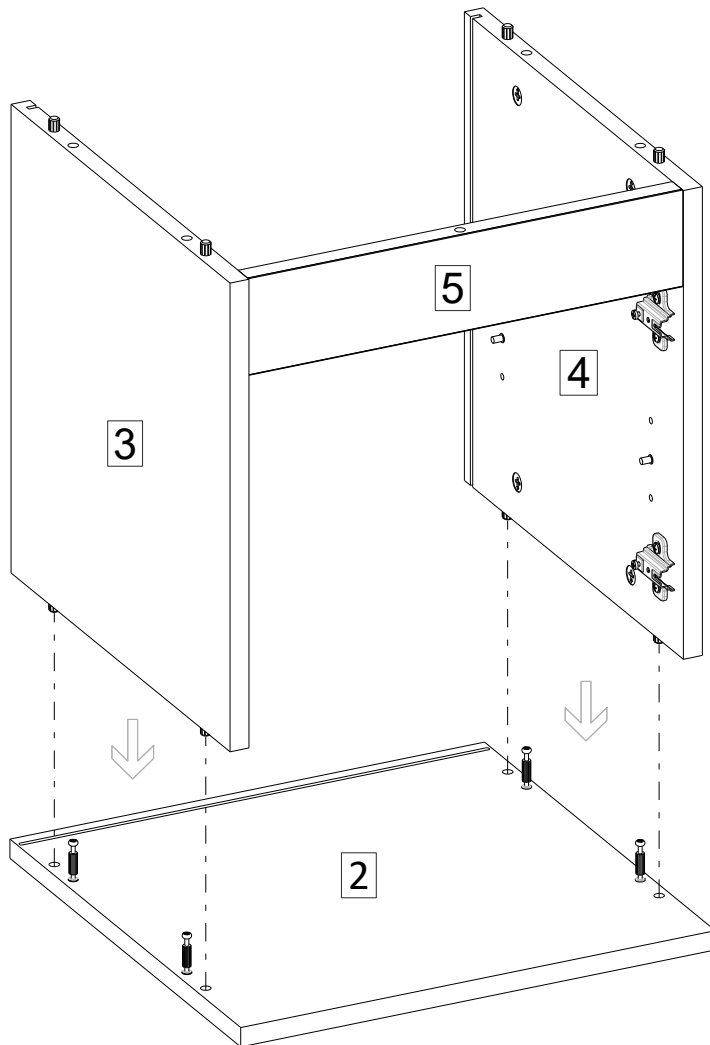
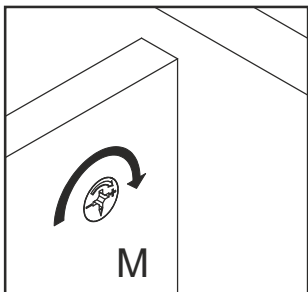
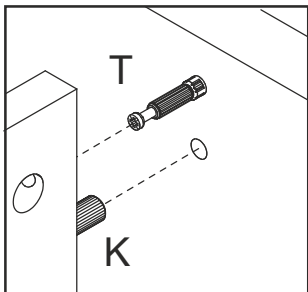
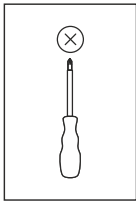

9

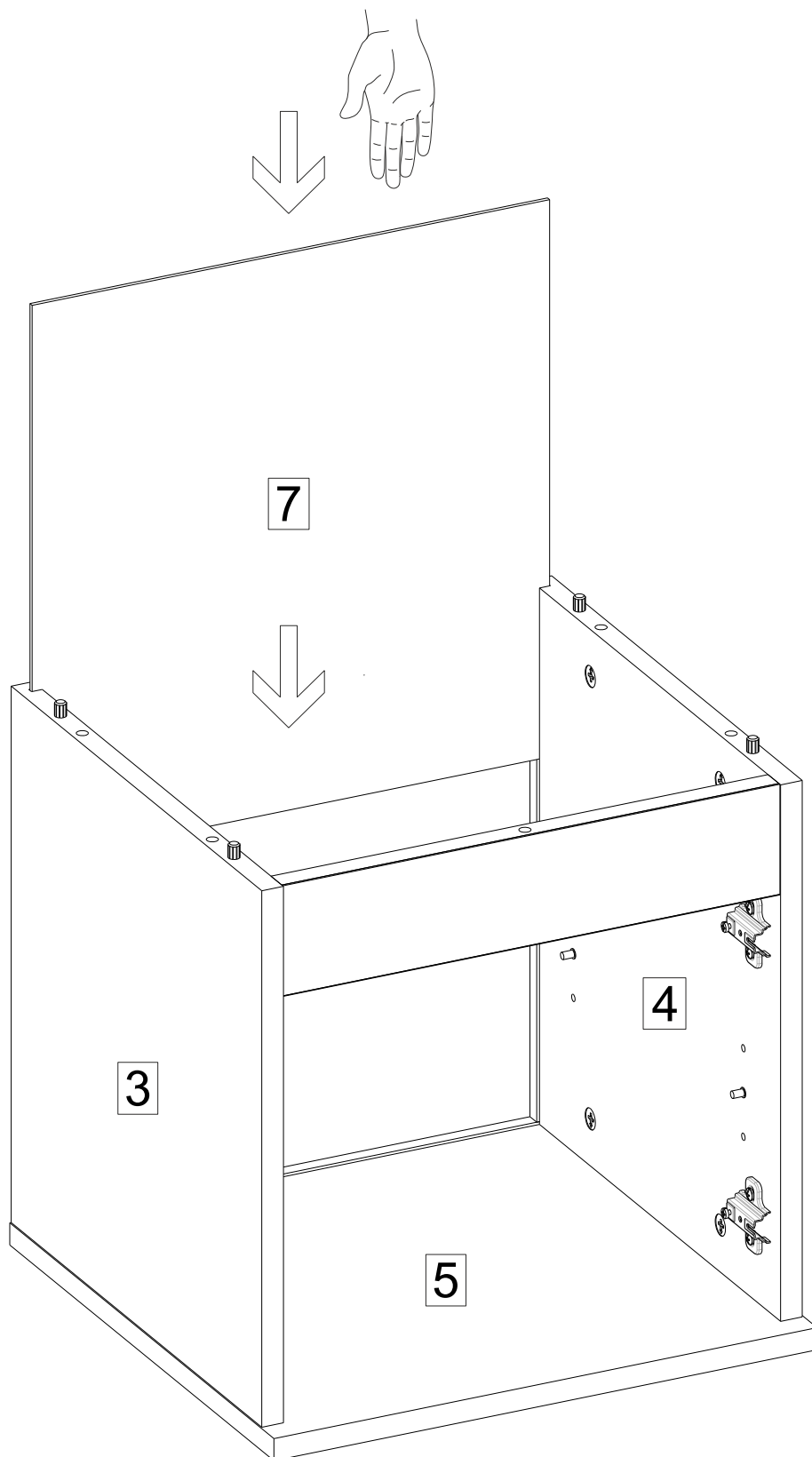

10

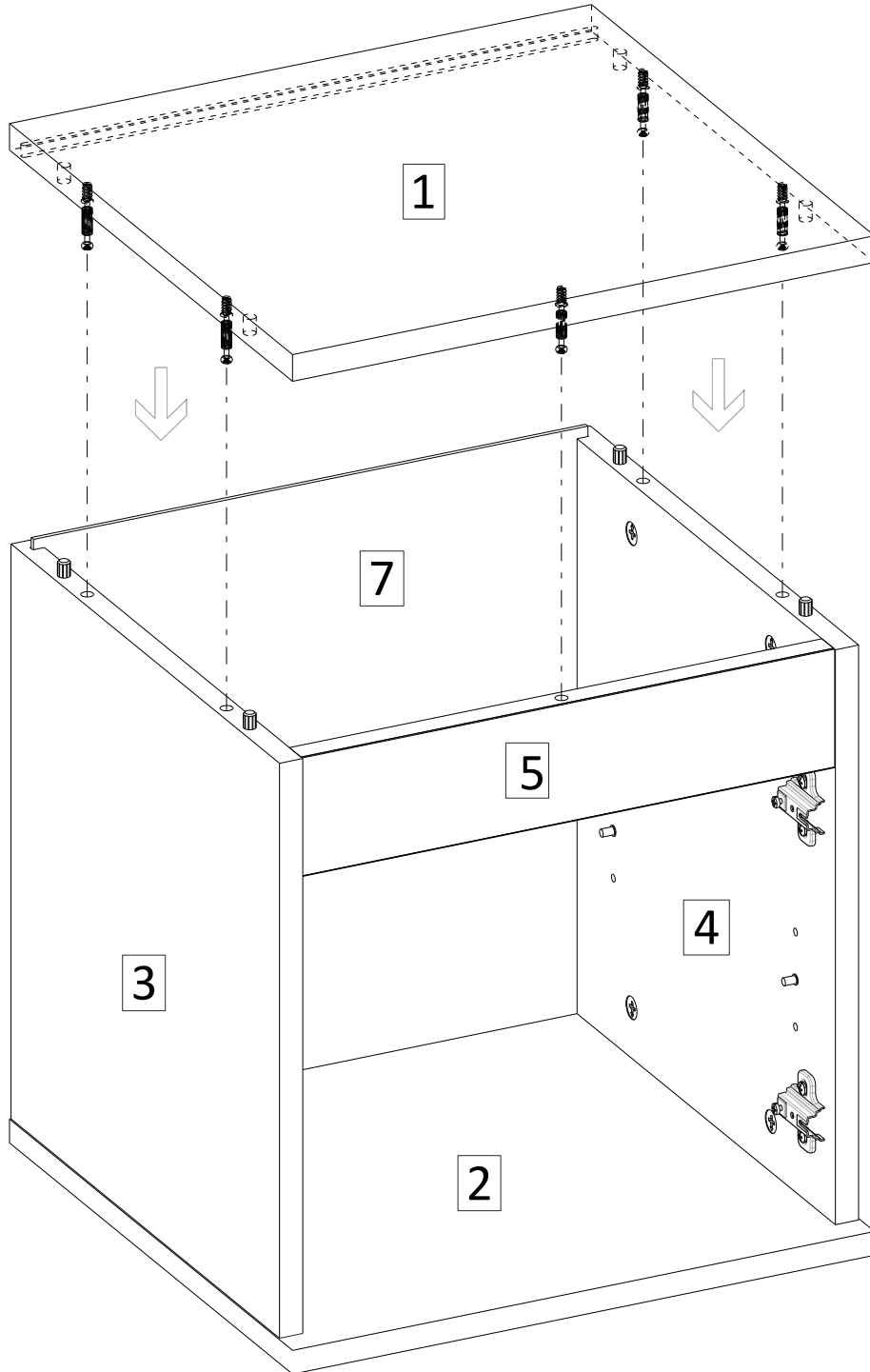
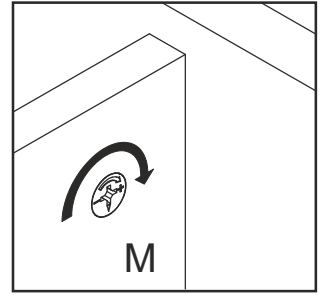
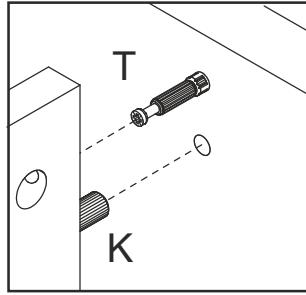
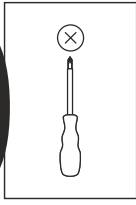

1 1

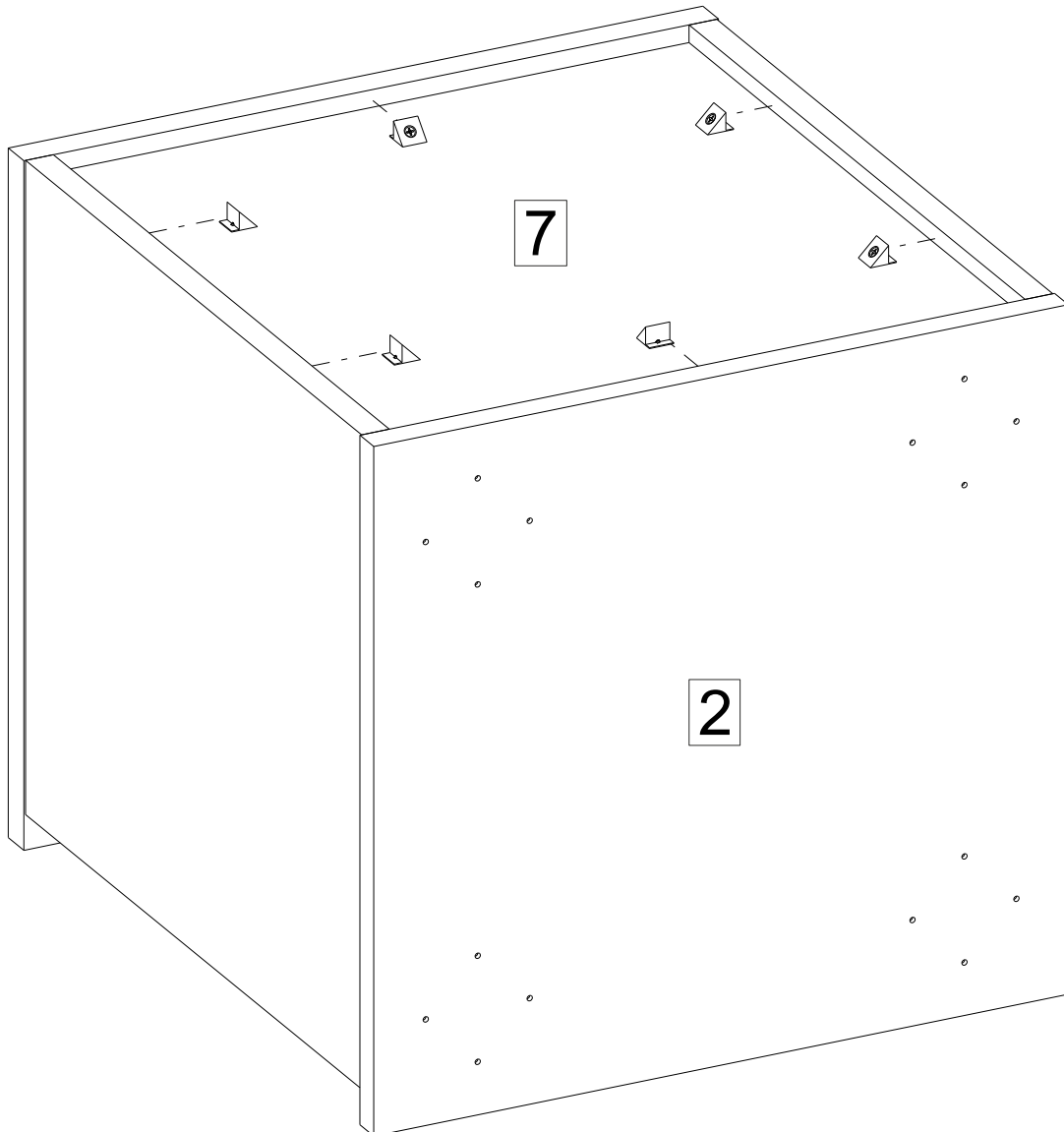
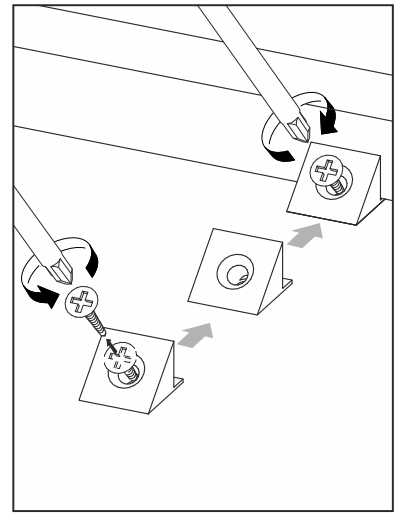
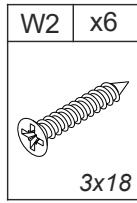
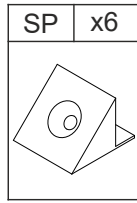
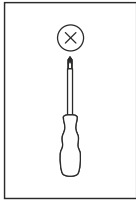

12

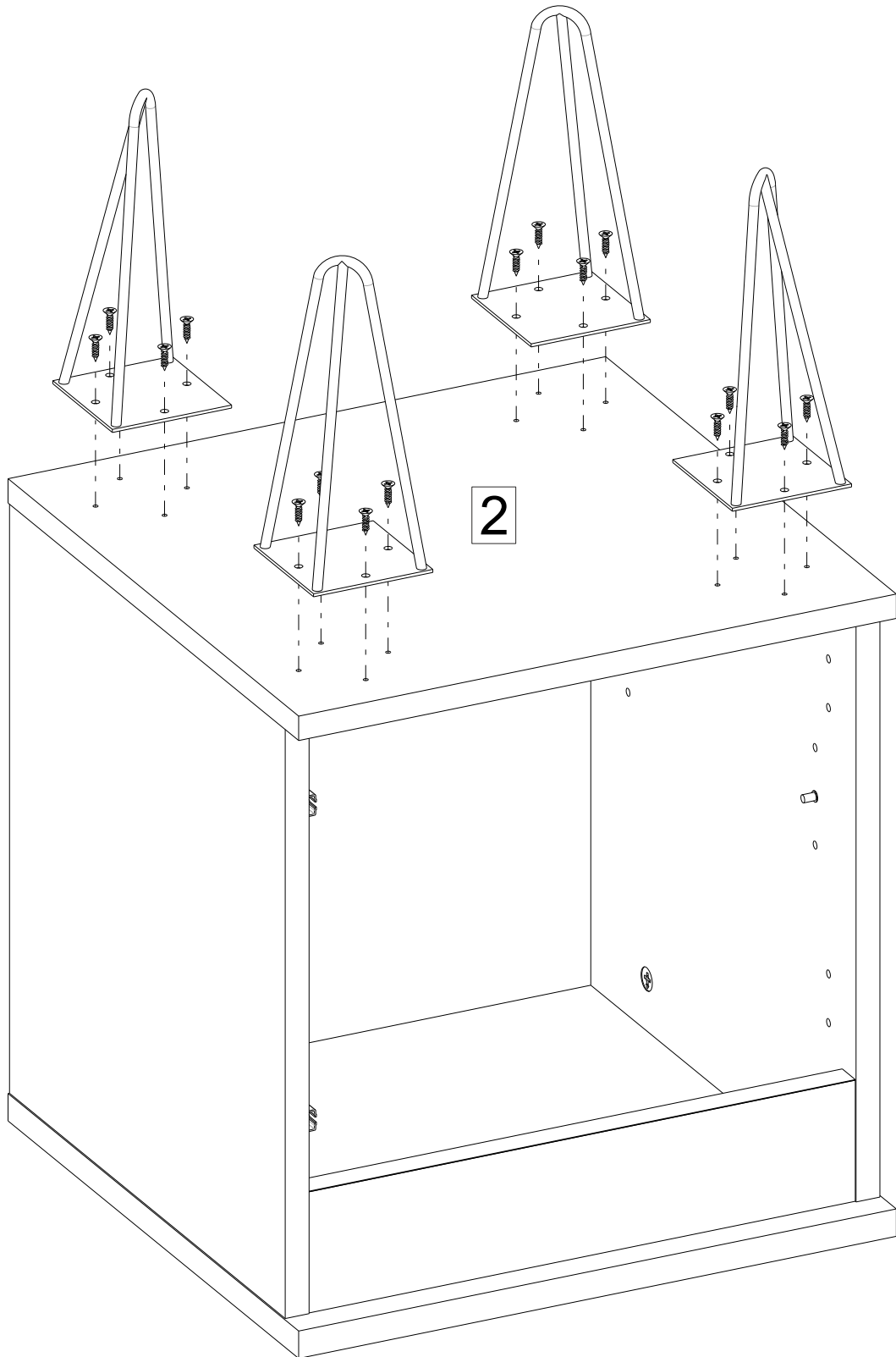
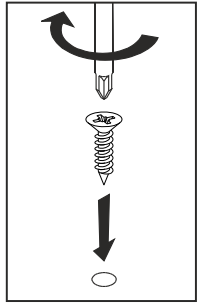
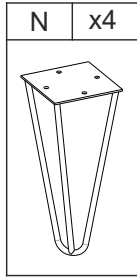
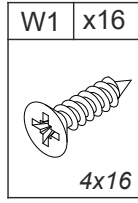
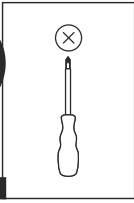

13

