

WARDROBE 4DR

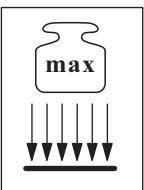

NO	Dim			Col.-No	Qty
1	1900	584	16	2	1
2	1900	584	16	2	1
3	2128	584	16	1	2
4	1056	80	16	1	2
5	1807	564	16	2	1
6	1056	564	16	3	2
7	1056	538	16	3	2
8	2128	60	16	1	2
9	1834	536	16	4	2
10	1834	536	16	5	2
11	1834	534	3	4	2
11	1827	534	3	5	2

NO	Inch			Col.-No	Qty
1	74 4/5	22 63/64	5/8	2	1
2	74 4/5	22 63/64	5/8	2	1
3	83 7/9	22 63/64	5/8	2	1
4	41 4/7	3 1/7	5/8	2	1
5	71 1/7	22 1/5	5/8	2	1
6	41 4/7	22 1/5	5/8	3	2
7	41 4/7	21 1/6	5/8	3	2
8	83 7/9	2 1/3	5/8	1	2
9	72 1/5	21 1/9	5/8	4	2
10	72 1/5	21 1/9	5/8	5	2
11	72 1/5	21 1/32	1/8	4	2
11	71 59/64	21 1/32	1/8	5	2

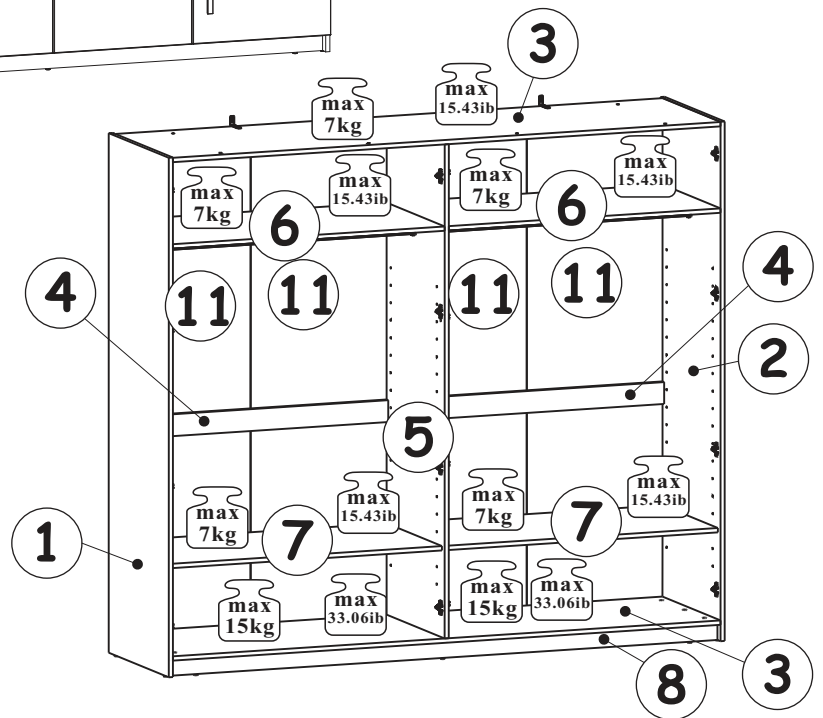
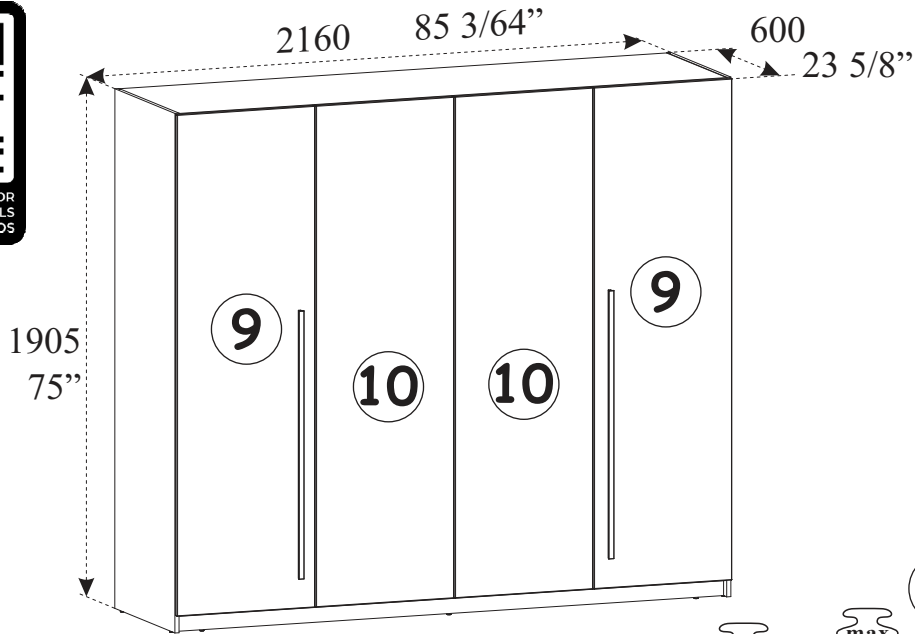
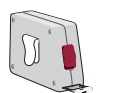
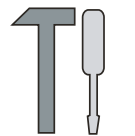
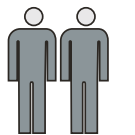





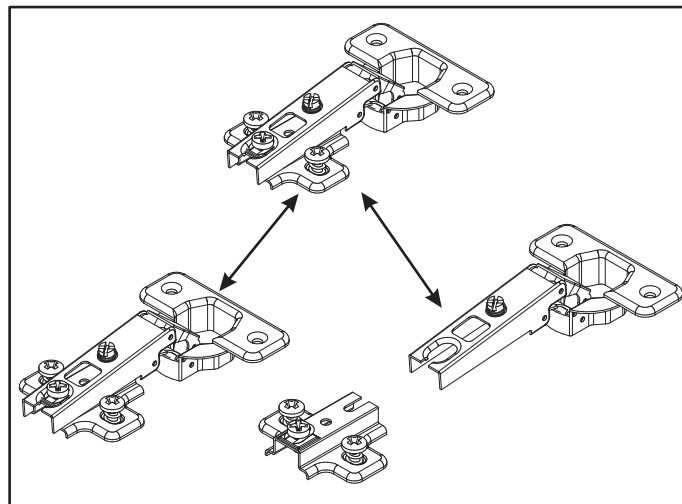
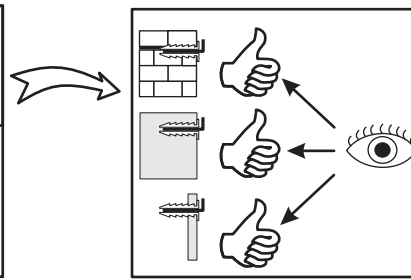
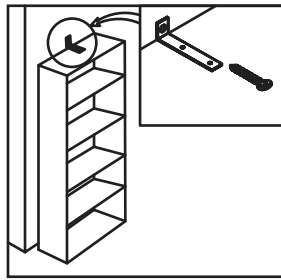
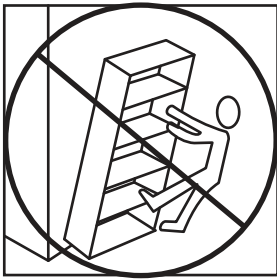
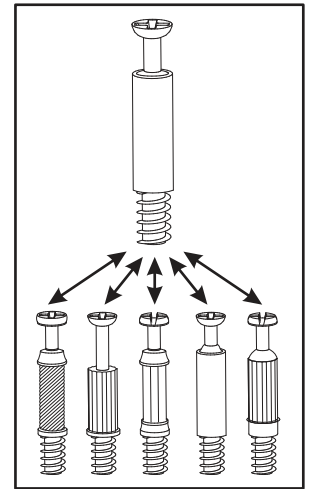
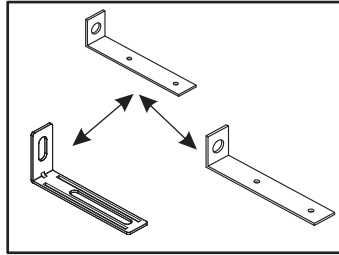
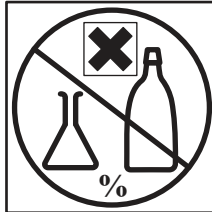
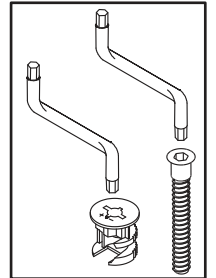
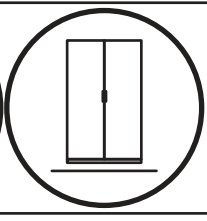
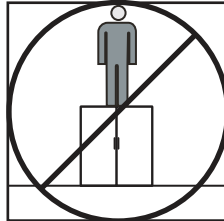
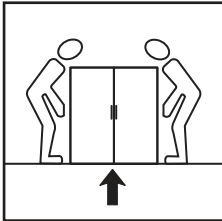
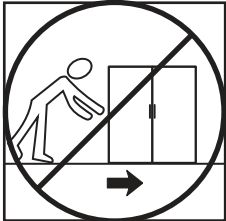
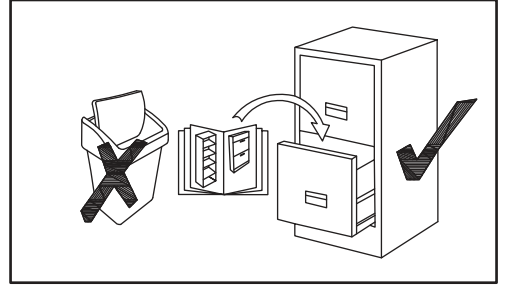
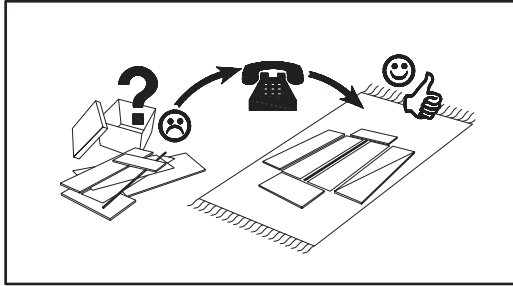
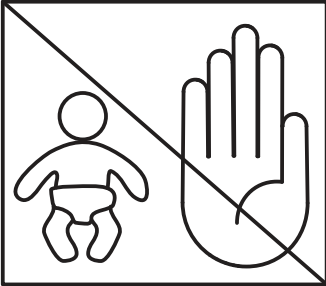
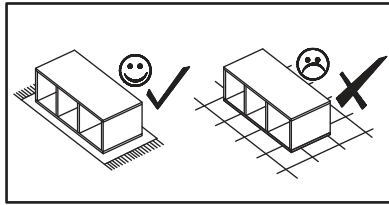
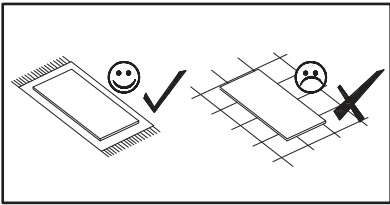



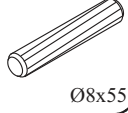
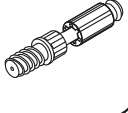

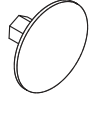
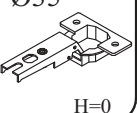
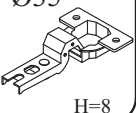
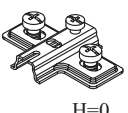
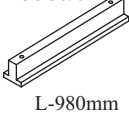
90 min

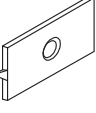
WARDROBE 4DR

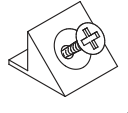

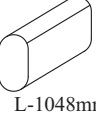
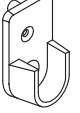
WARDROBE 4DR

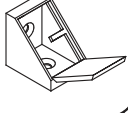
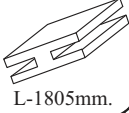
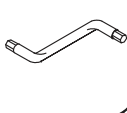
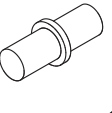
A1 X34	$\text{Ø}5/16'' \times 1\ 27/64''$  $\text{Ø}8 \times 36$	A8 X3	 $\text{Ø}8 \times 55$	B4 X26		B6 x4	$\text{Ø}9/32'' \times 2\ 63/64''$  $\text{Ø}7 \times 76$	B5 X34	$\text{Ø}19/32'' \times 15/32''$  $\text{Ø}15 \times 12$	G5 X34	
E21 x8	$\text{Ø}35$  H=0	E23 x8	$\text{Ø}35$  H=8	E2 x16	 H=0	T03 x2	L-38 $37/64''$  L-980mm	D6 x8	US $\text{Ø}9/64'' \times 1\ 3/16''$  US $\text{Ø}3,5 \times 30$	G16 X13	
KR5 SFXP x2	$\text{Ø} 25/64'' \times 1\ 31/32''$ $\times 2\ 23/64''$  $\text{Ø}10/50 \times 60$	L1 x2	$2\ 29/32'' \times 1\ 11/32''$ $\times 19/32''$  74x34x15	S1 X14		I2 x10		C5 x2	L-41 $17/64''$  L-1048mm	G10 x4	
D10 x52	US $\text{Ø}9/64'' \times 33/64''$  US $\text{Ø}3,5 \times 13$	UP13 X69	US $\text{Ø}1/8'' \times 5/8''$  UP $\text{Ø}3 \times 16$	KM1 x6		G8 x2	L-71 $1/16''$  L-1805mm.	G2 x1		G7 x8	

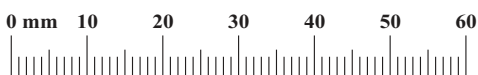
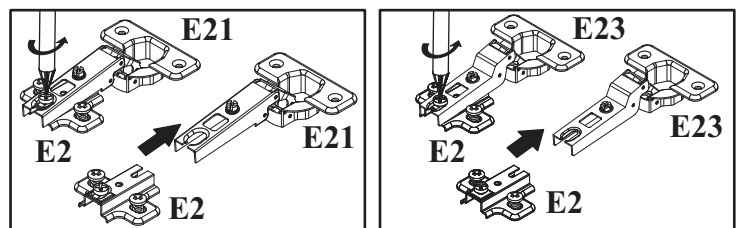

WARDROBE 4DR

1

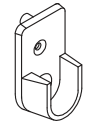
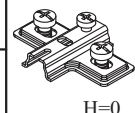
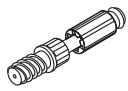
G10		E2		B4	
x1		x4	H=0	X10	

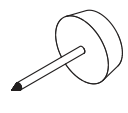
I2	
x2	

D10	USØ9/64"x33/64"
x1	USØ3,5x13

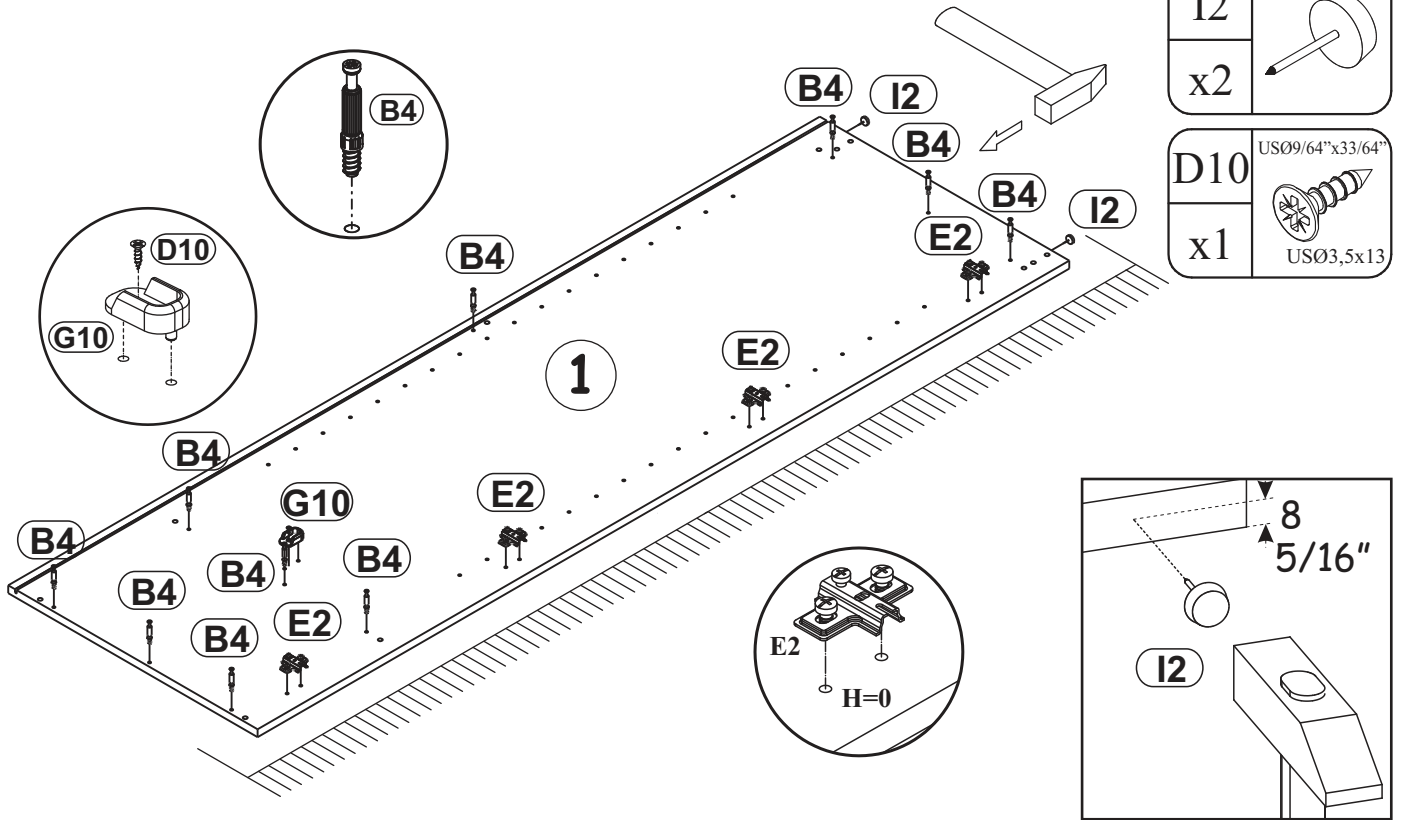

2

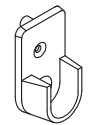
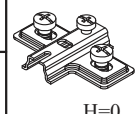
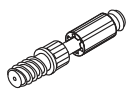
D10	USØ9/64"x33/64"	G10		E2		B4	
x1	USØ3,5x13	x1		x4	H=0	X10	

I2	
x2	

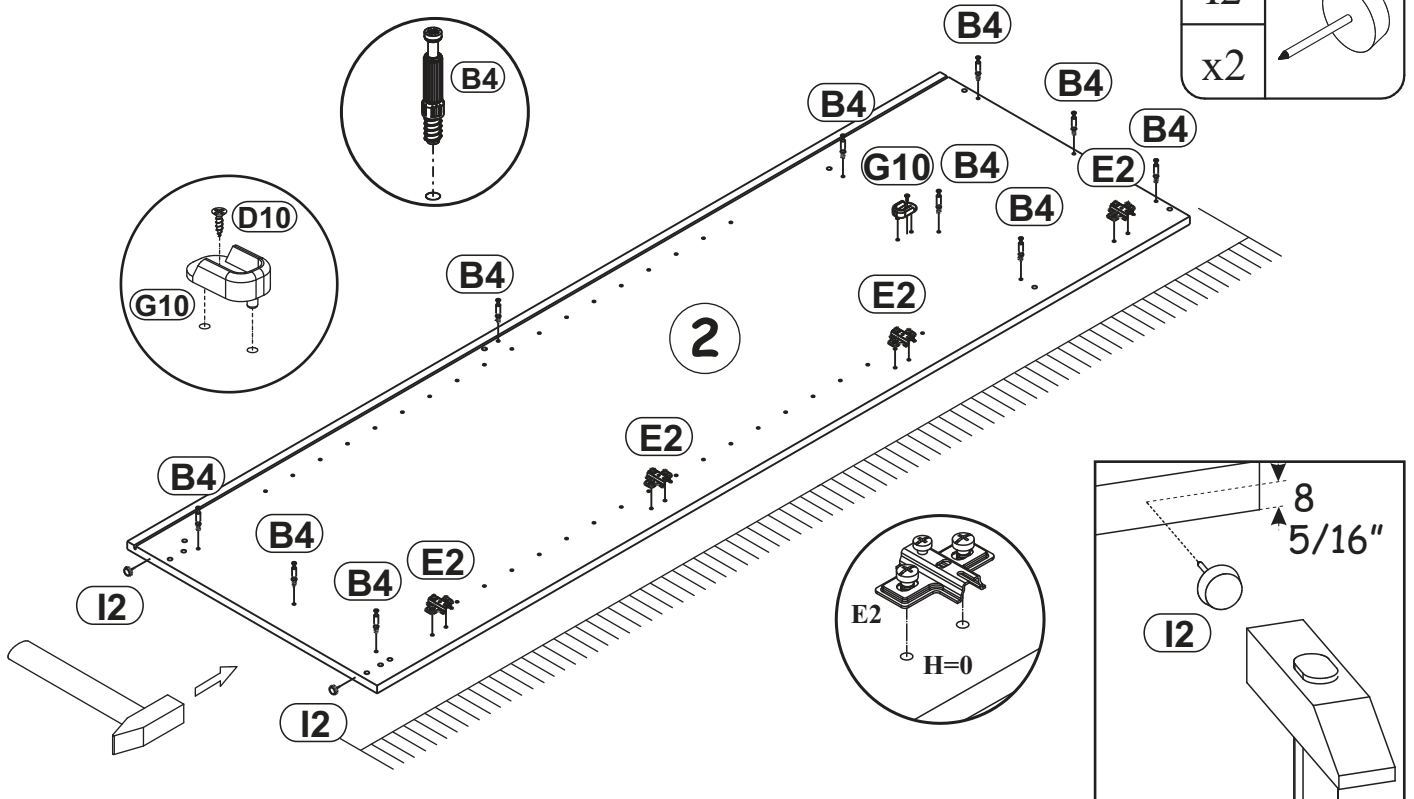



WARDROBE 4DR

3

A1	Ø5/16"x1 27/64"
x4	 ø8x36

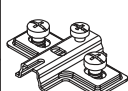
B5	Ø19/32"x15/32"
x6	 Ø15x12

E2	
x8	H=0

D10	USØ9/64"x33/64"
x2	 USØ3,5x13

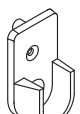
G10	
x2	

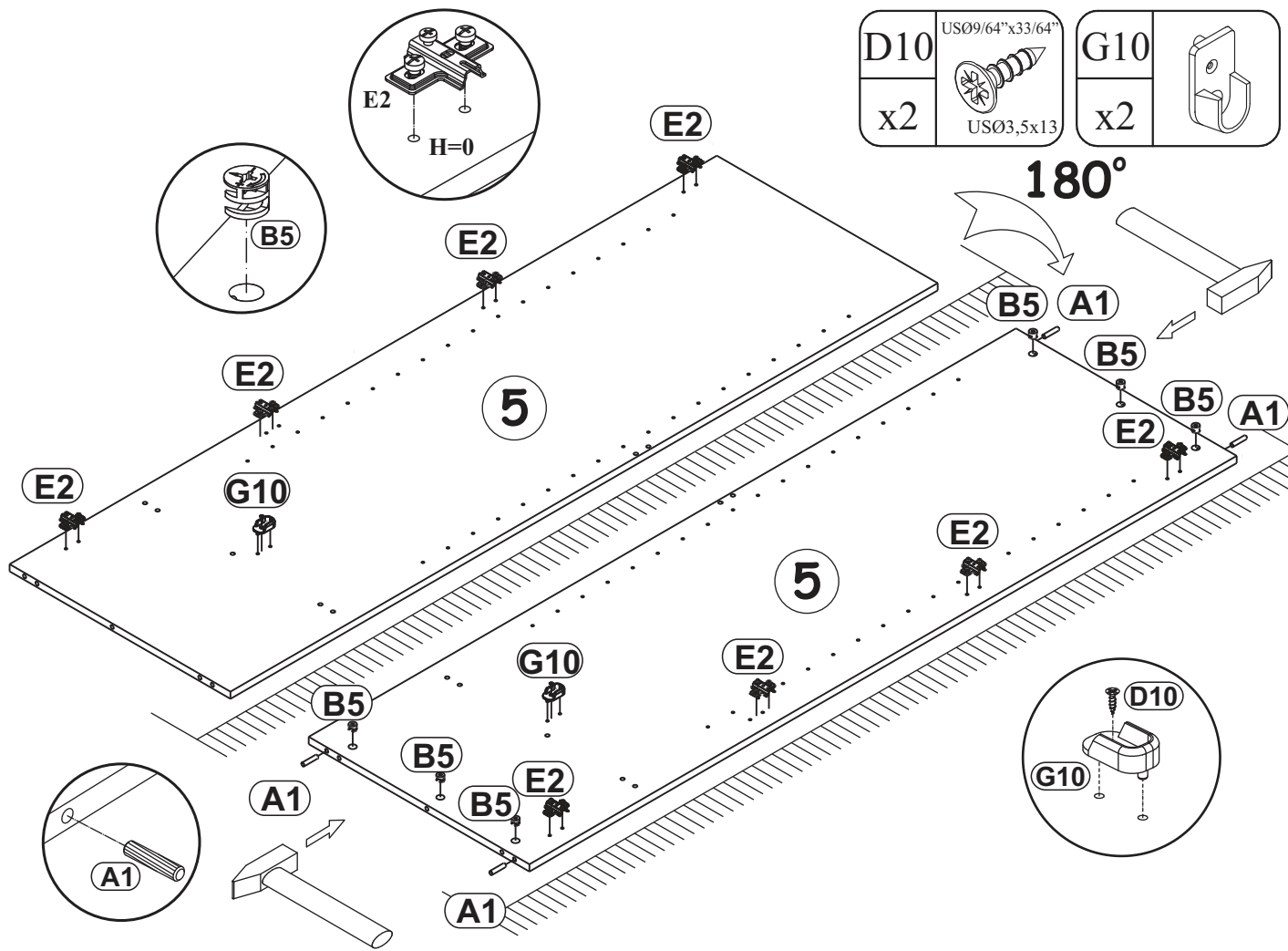

4

A1	Ø5/16"x1 27/64"
X4	 ø8x36

B5	Ø19/32"x15/32"
x12	 Ø15x12

A8	
X2	Ø8x55

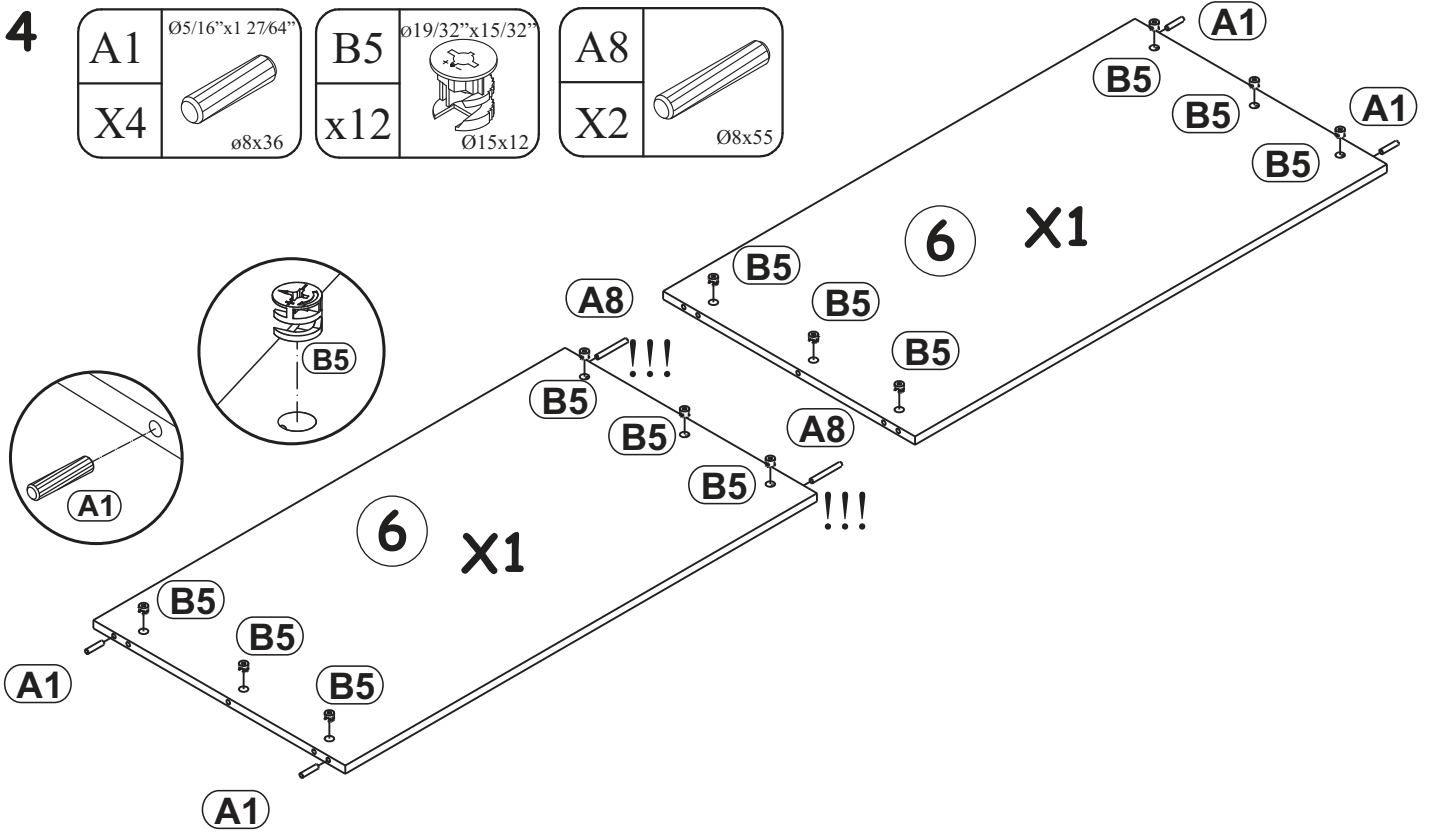

WARDROBE 4DR

5

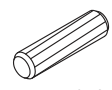
B5	Ø19/32"x15/32"	A1	Ø5/16"x1 27/64"
X4		X2	
	Ø15x12		Ø8x36

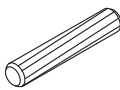
A8	
X1	Ø8x55

1X

4

4

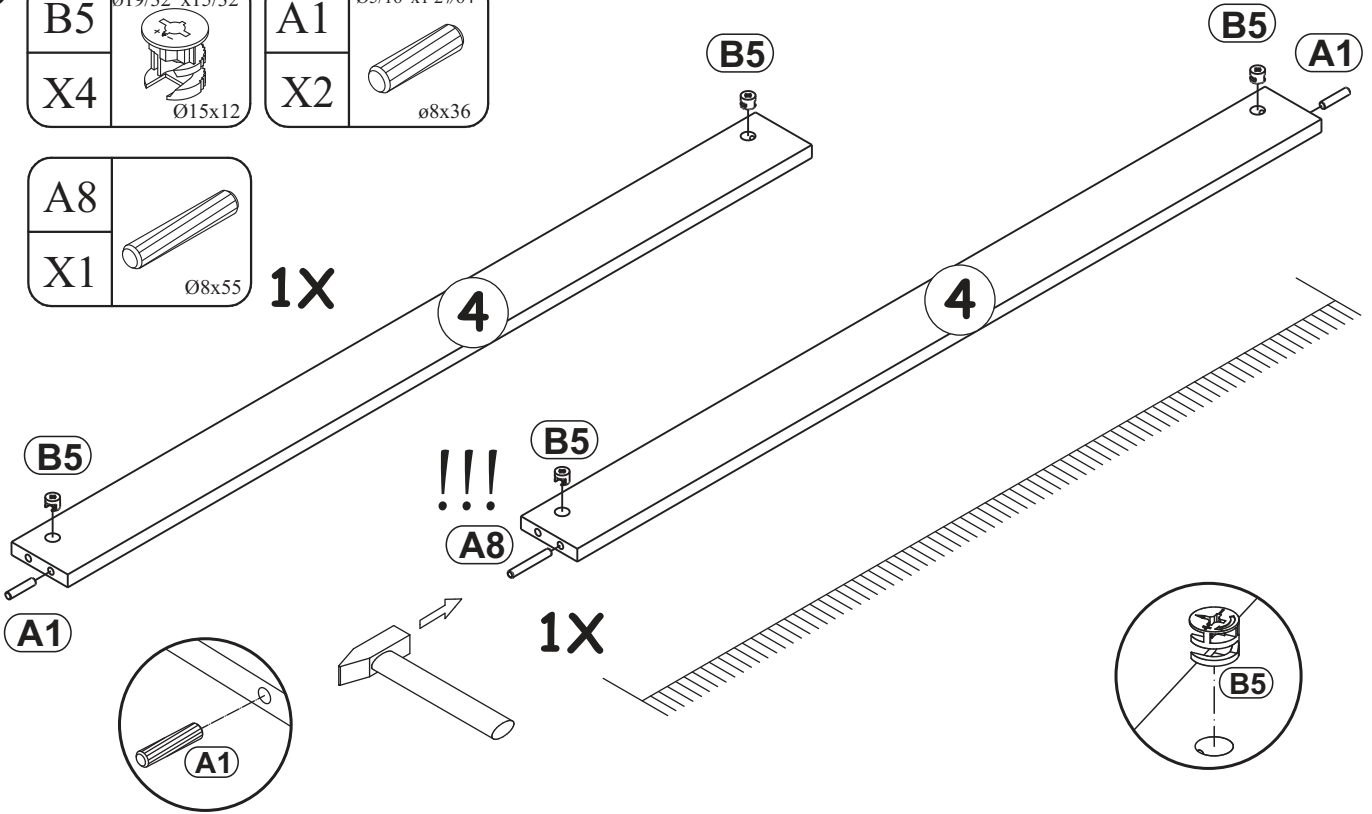

6

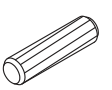
B5	Ø19/32"x15/32"	A1	Ø5/16"x1 27/64"
X12		X24	
	Ø15x12		Ø8x36

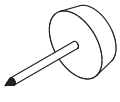
I2	
x6	

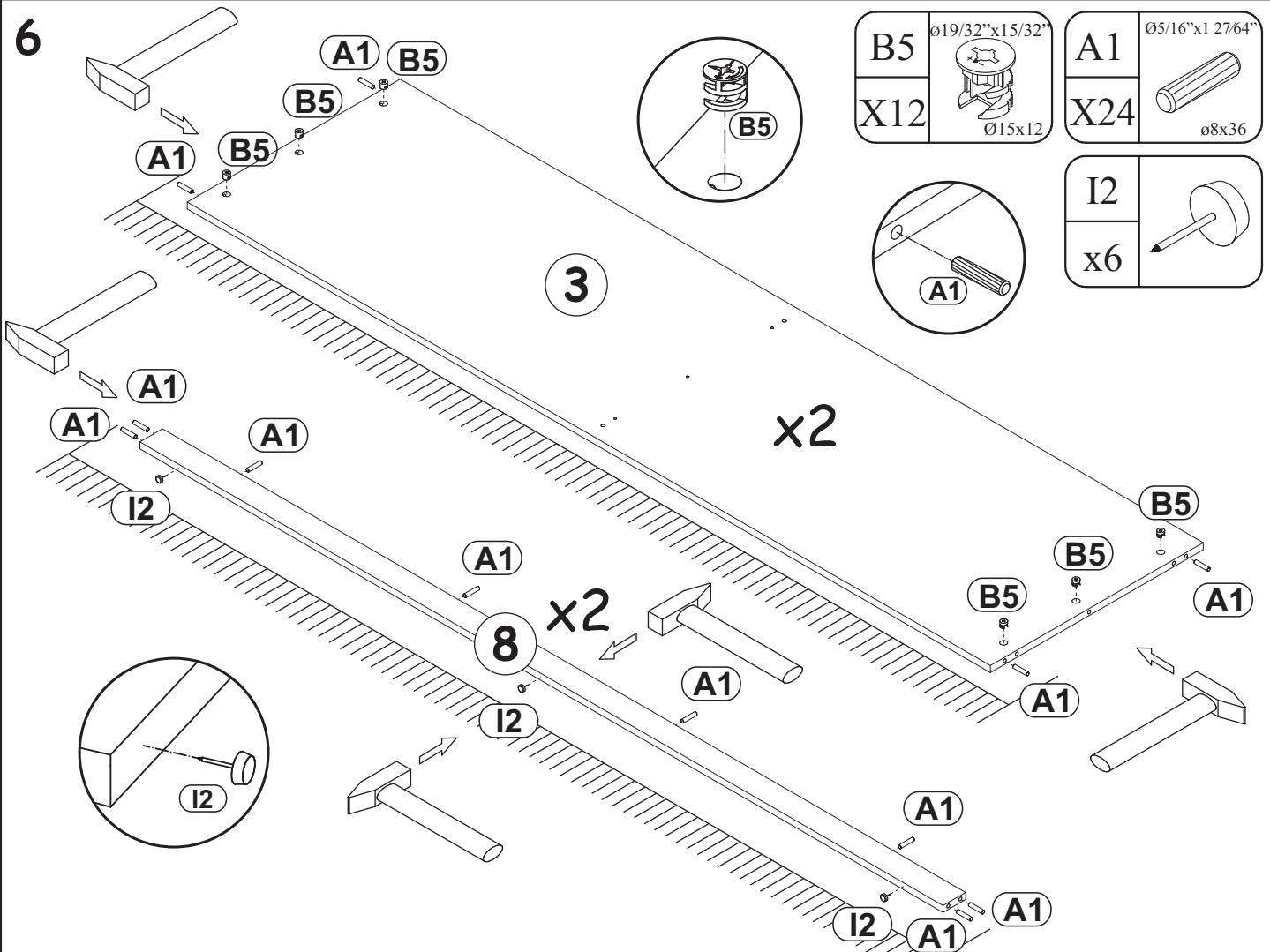

WARDROBE 4DR

7

D10	USØ9/64"x33/64"	E21	Ø35
x16	USØ3,5x13	x8	H=0

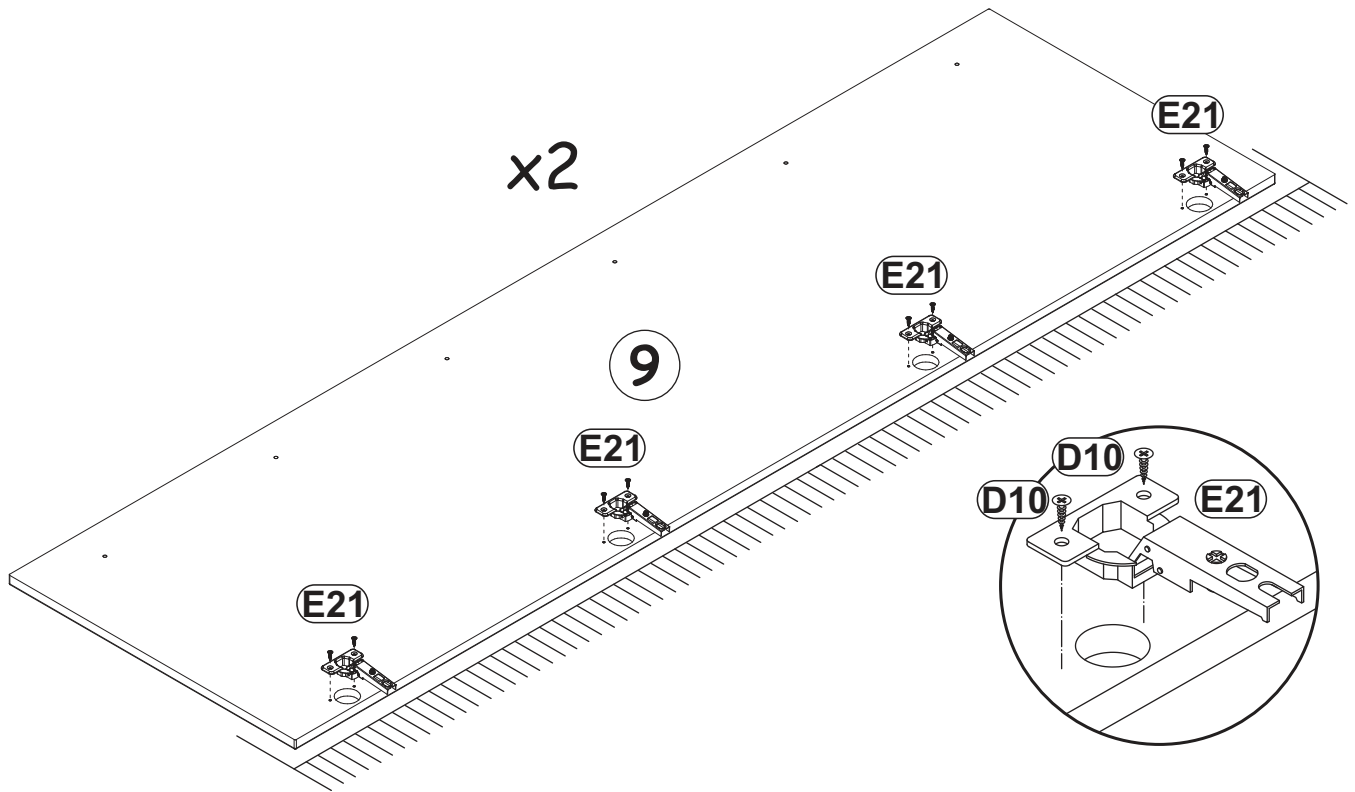

8

D10	USØ9/64"x33/64"	E23	Ø35
x16	USØ3,5x13	x8	H=8

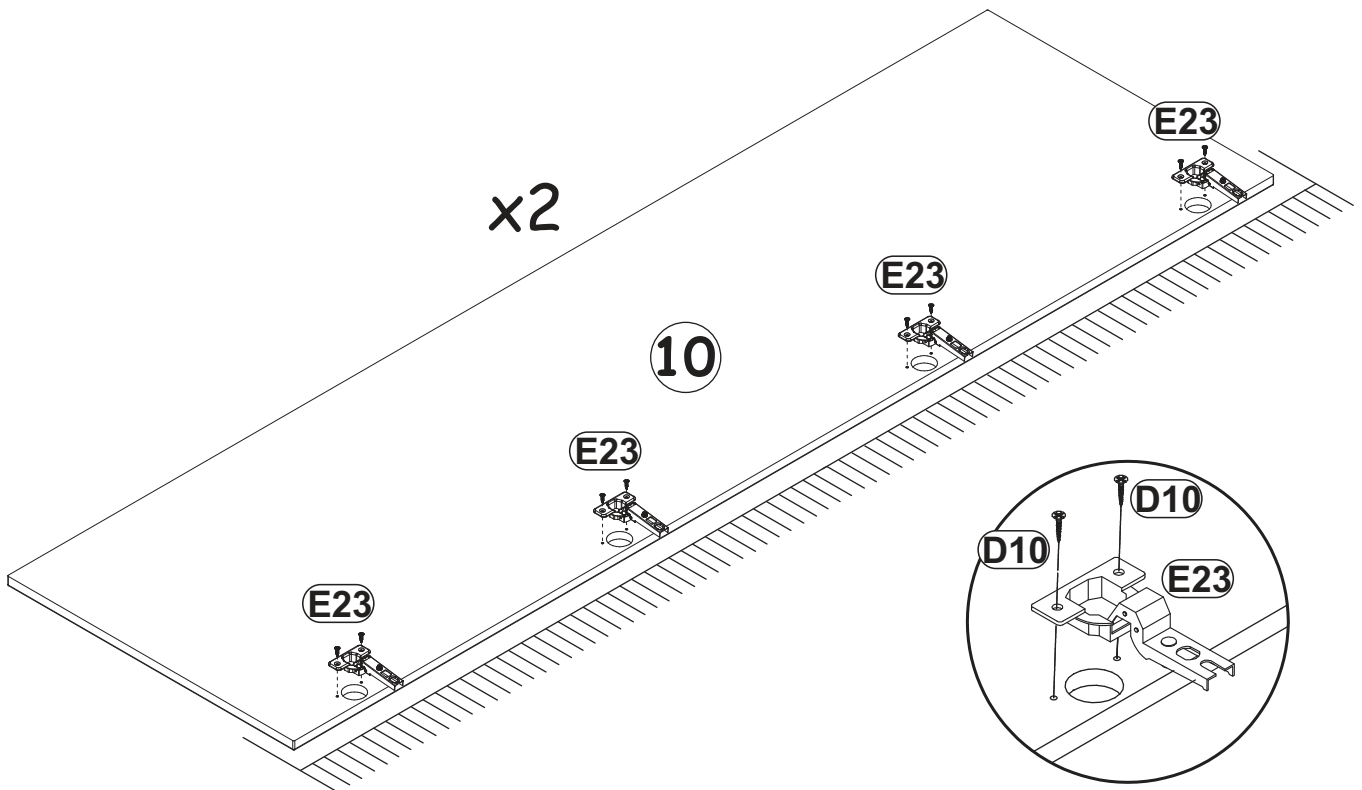

WARDROBE 4DR

9

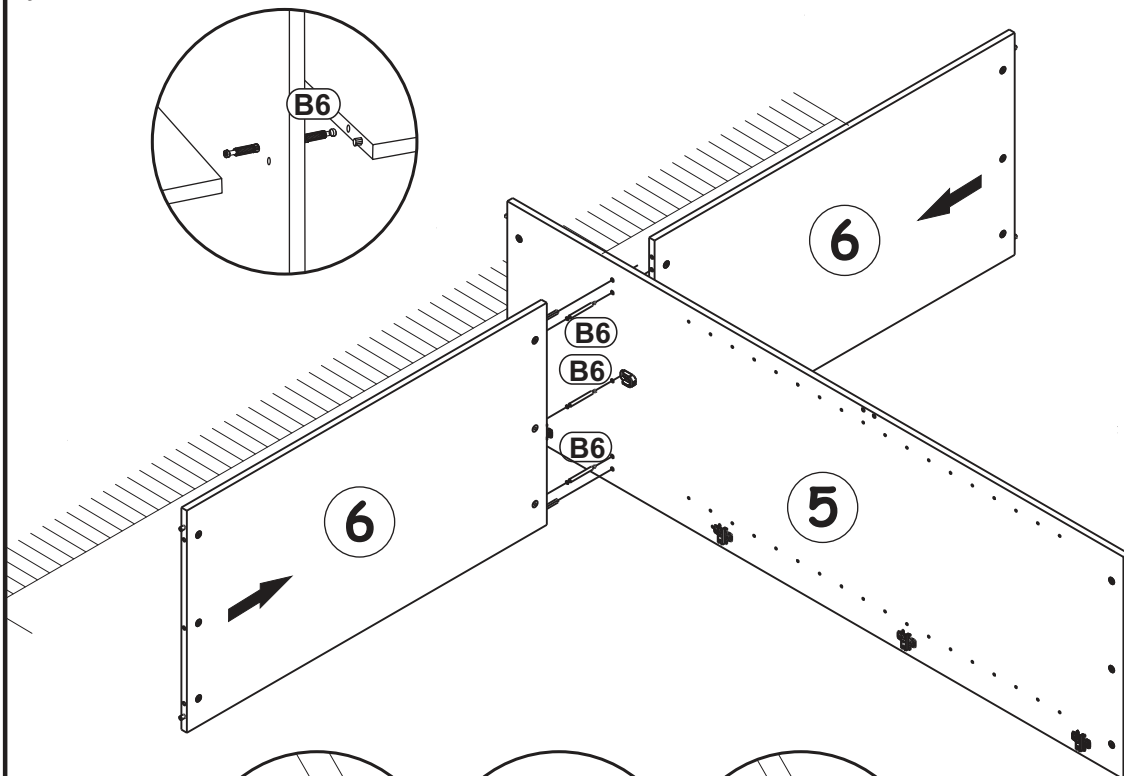
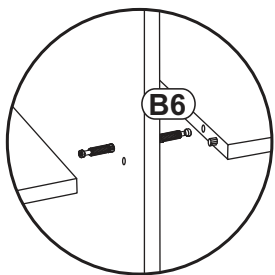

B6	Ø9/32"x2 63/64"
x3	
	Ø7x76

G5	
x6	

10

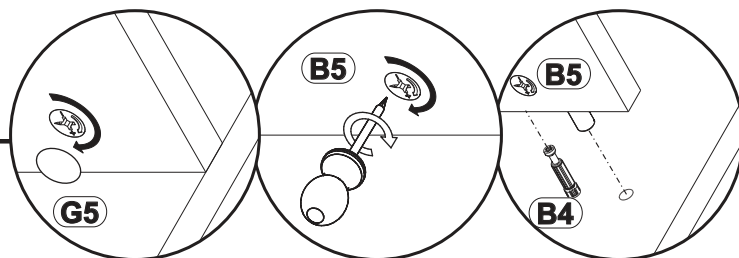

G5	
x3	

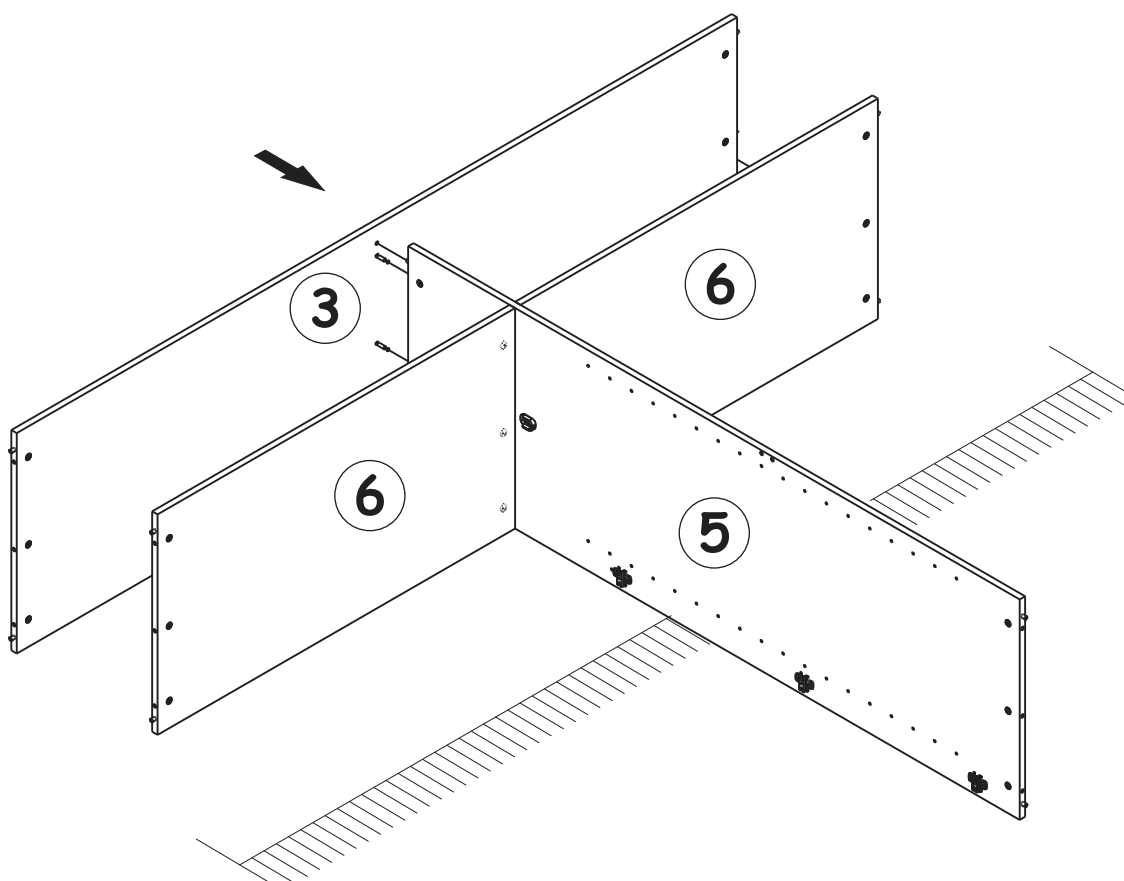

WARDROBE 4DR

11

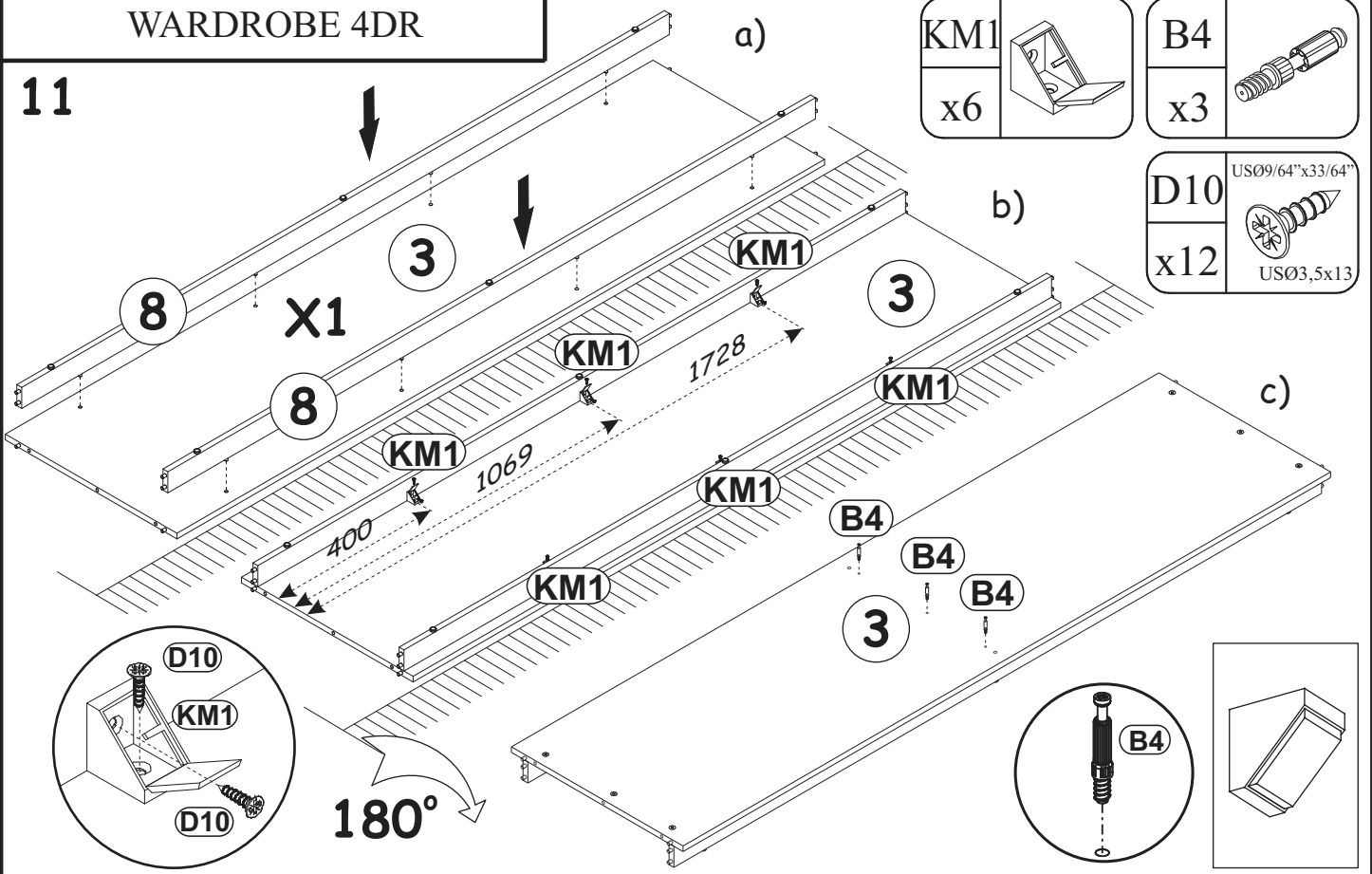

12

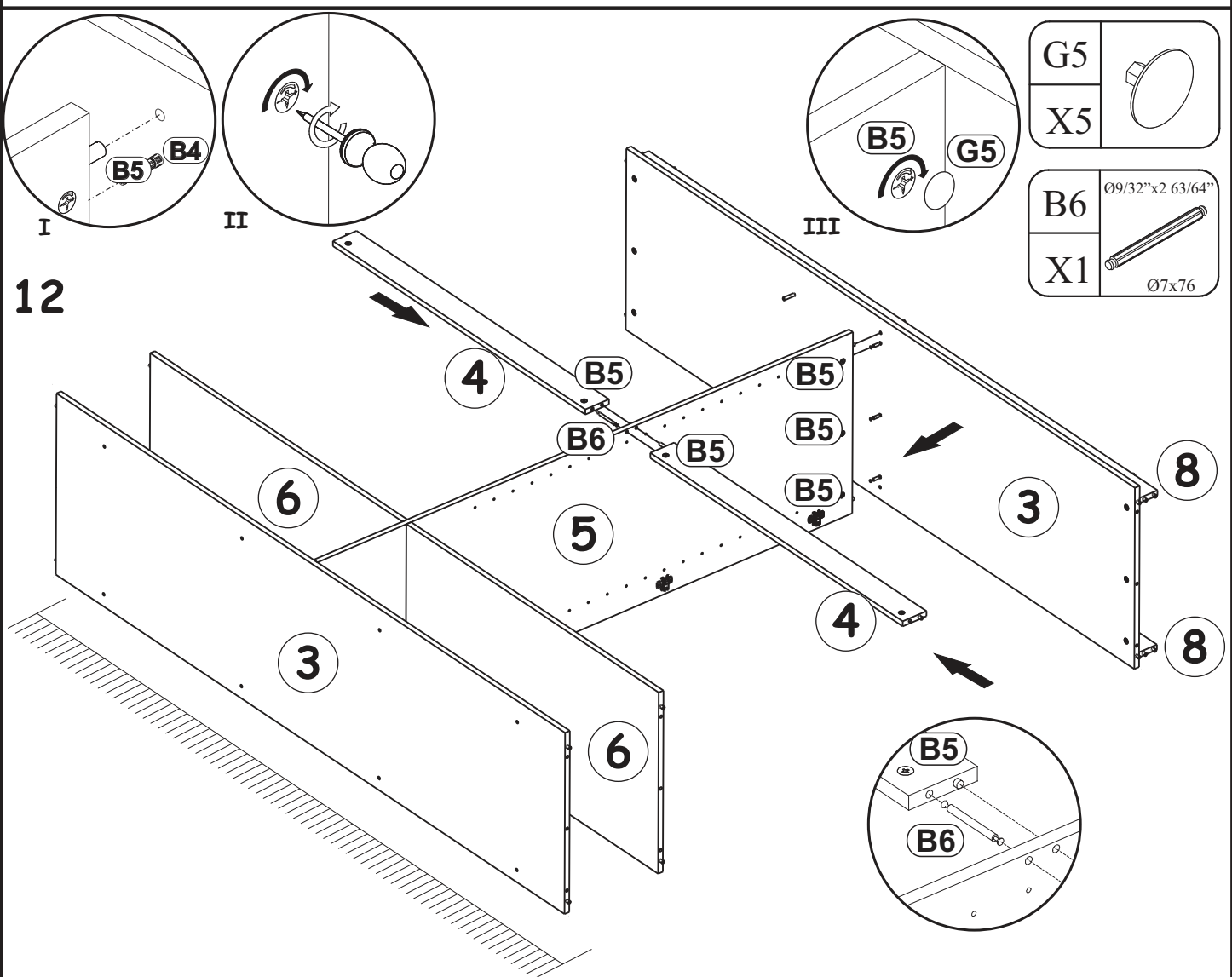

WARDROBE 4DR

13

G5	
X20	

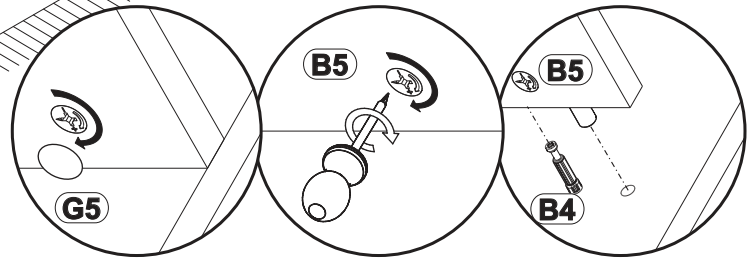
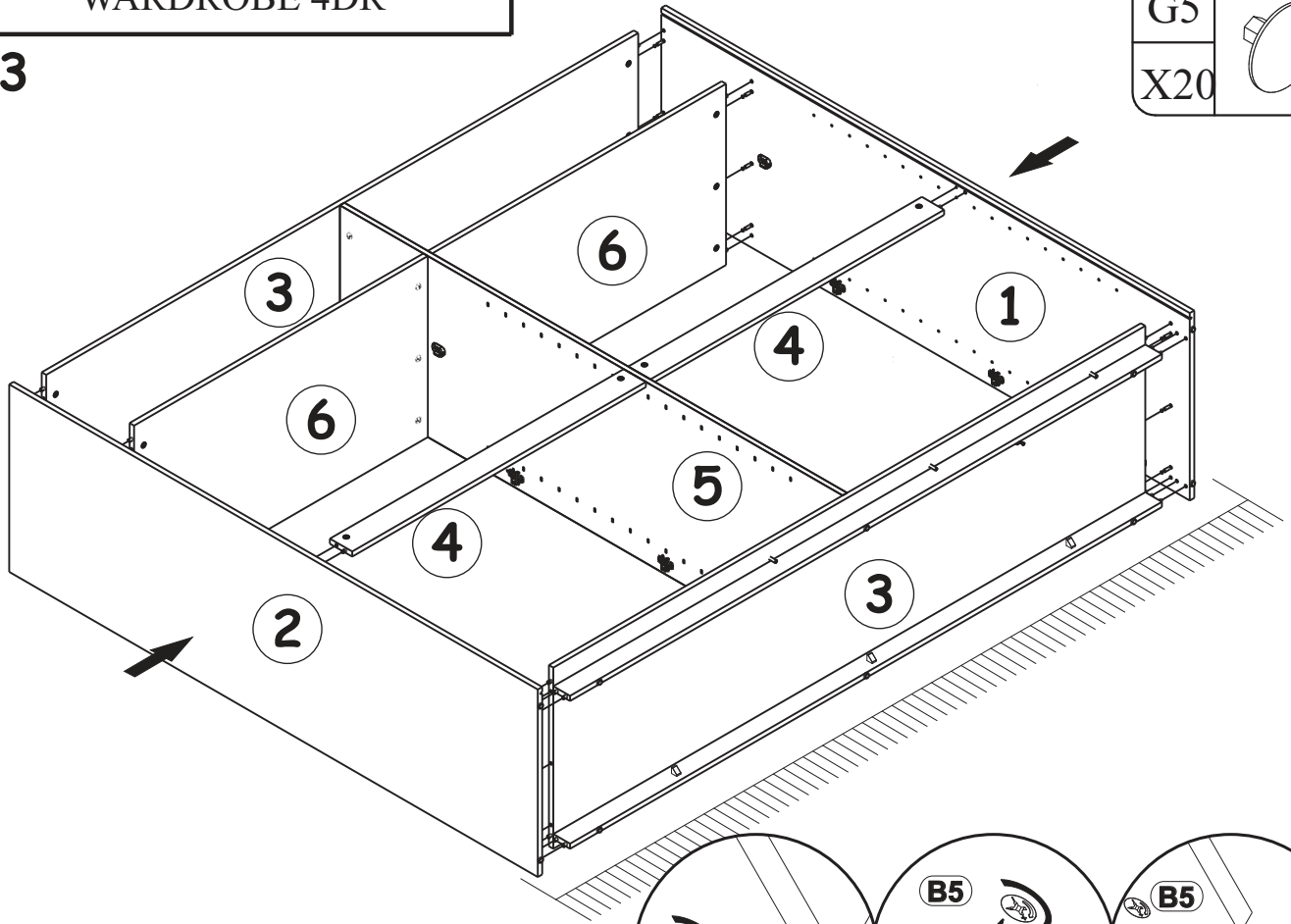

14

G8	L-71 1/16"
x2	L-1805mm.

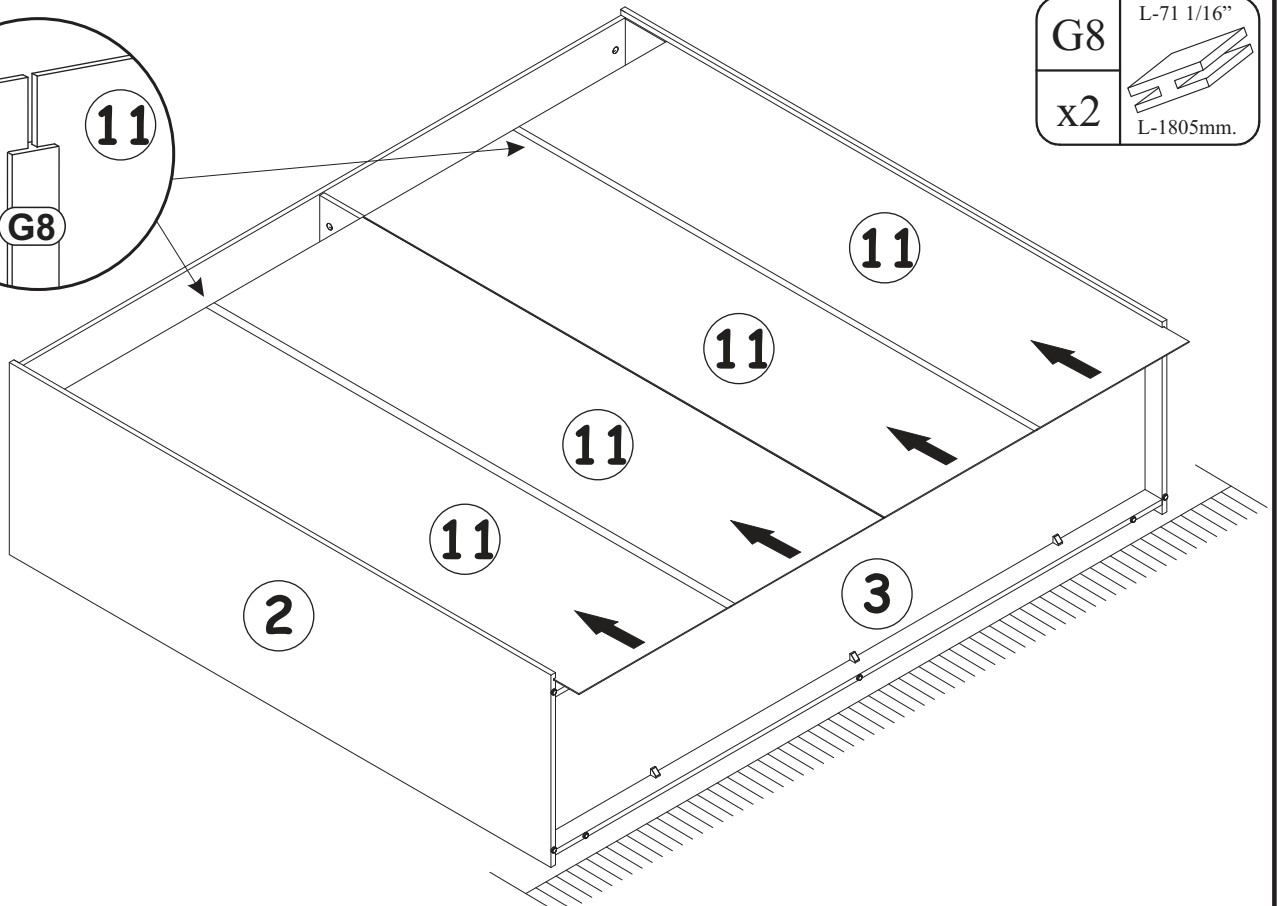
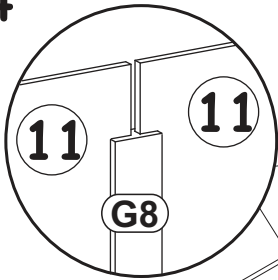
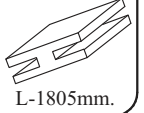

WARDROBE 4DR

15

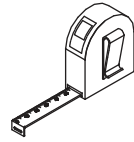

$X=Y$ 90°

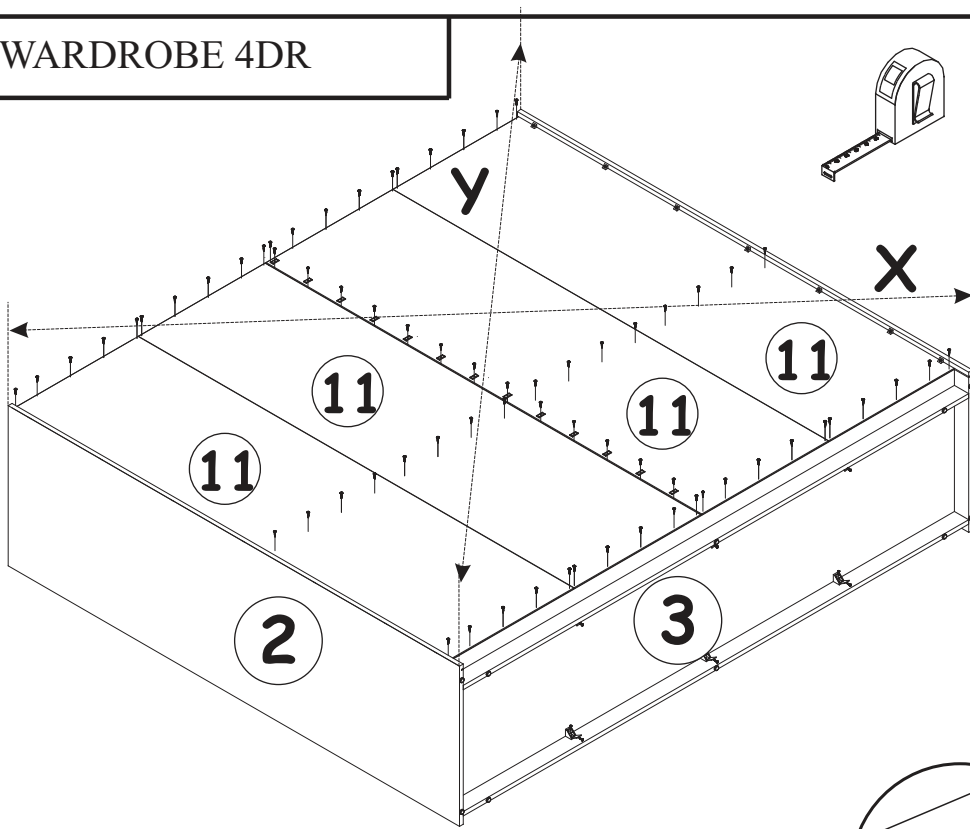

S1	
X14	

UP13	USØ1/8"x5/8"
X69	
	UPØ3x16

G16	
X13	

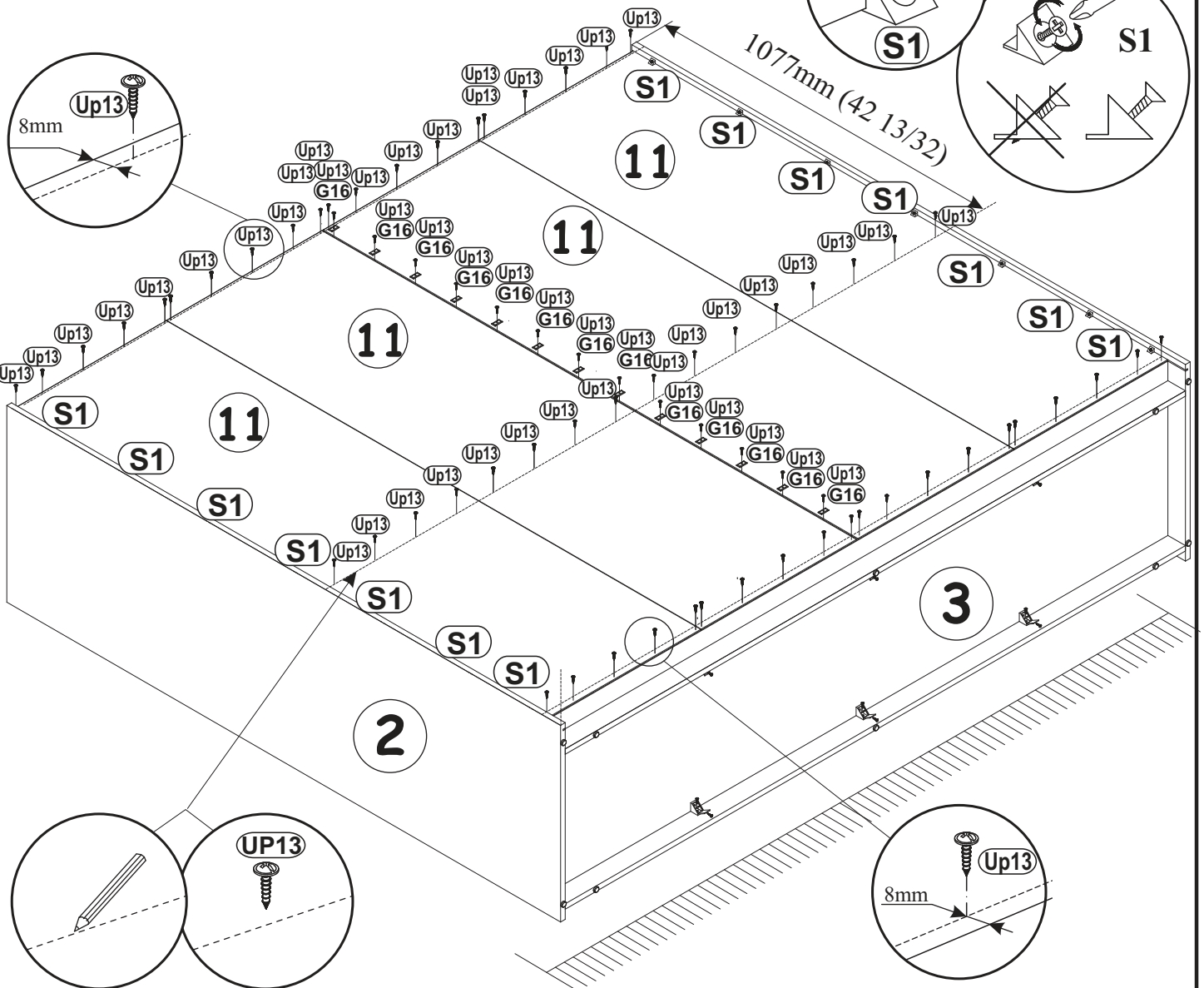
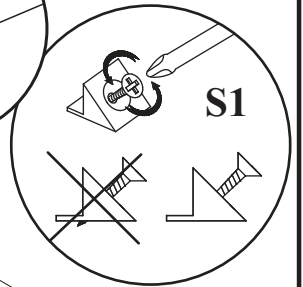
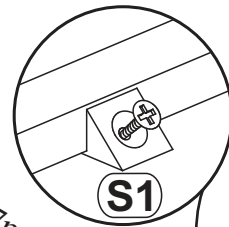

WARDROBE 4DR

16

D10 x4	USØ9/64"x33/64" USØ3,5x13	KR5 SFXP x2	Ø 25/64"/1 31/32" x2 23/64" Ø10/50x60	L1 x2	2 29/32"x1 11/32" x19/32" 74x34x15
------------------	------------------------------	--------------------------	---	-----------------	--

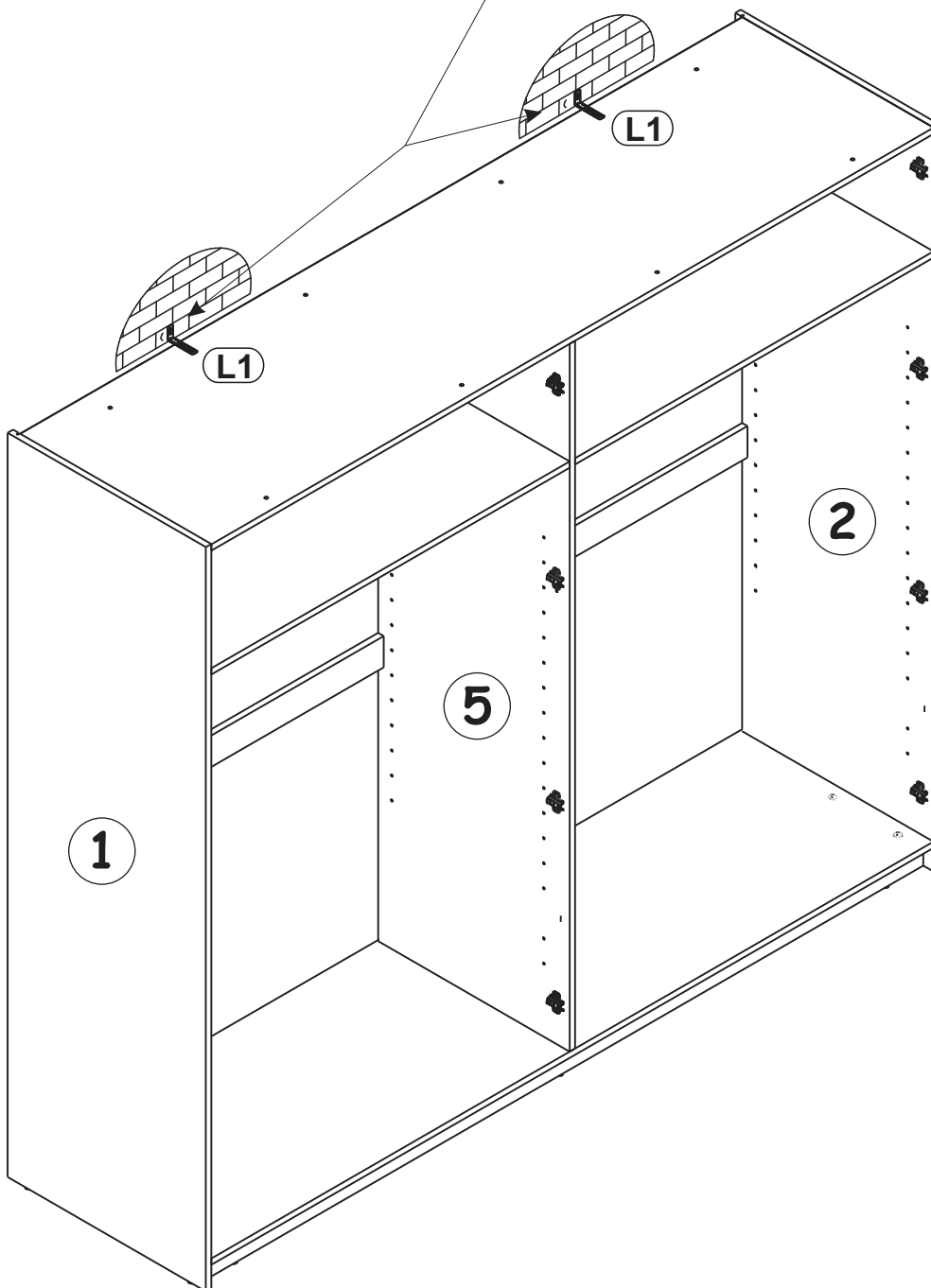
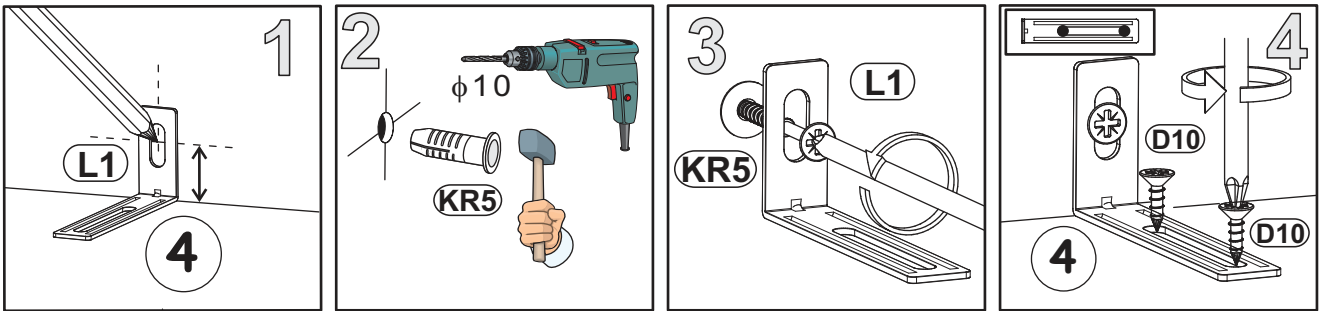

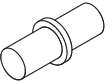
C5	L-41 17/64"	G7	
x2	L-1048mm	x8	

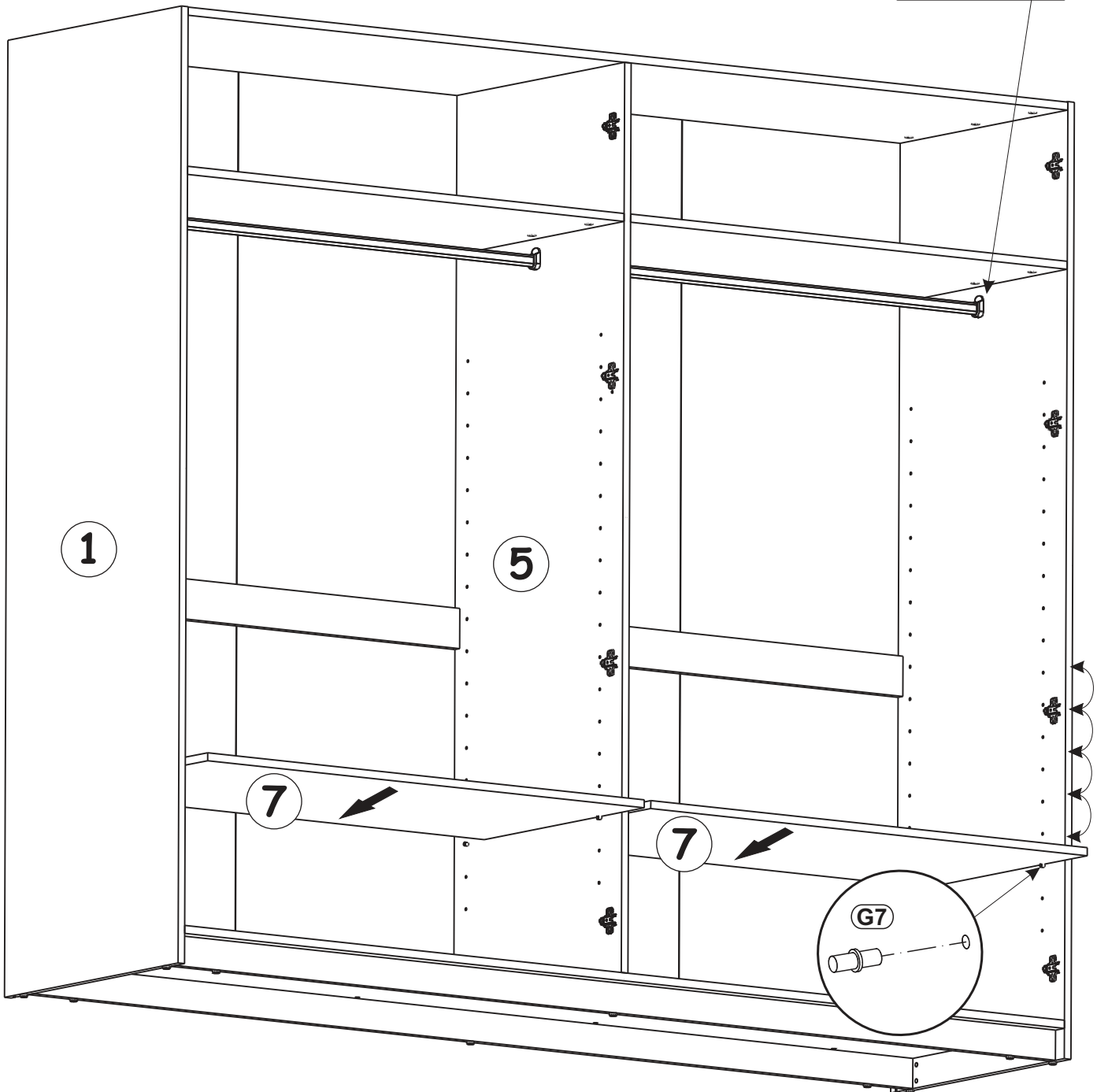
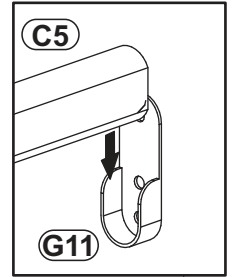

18

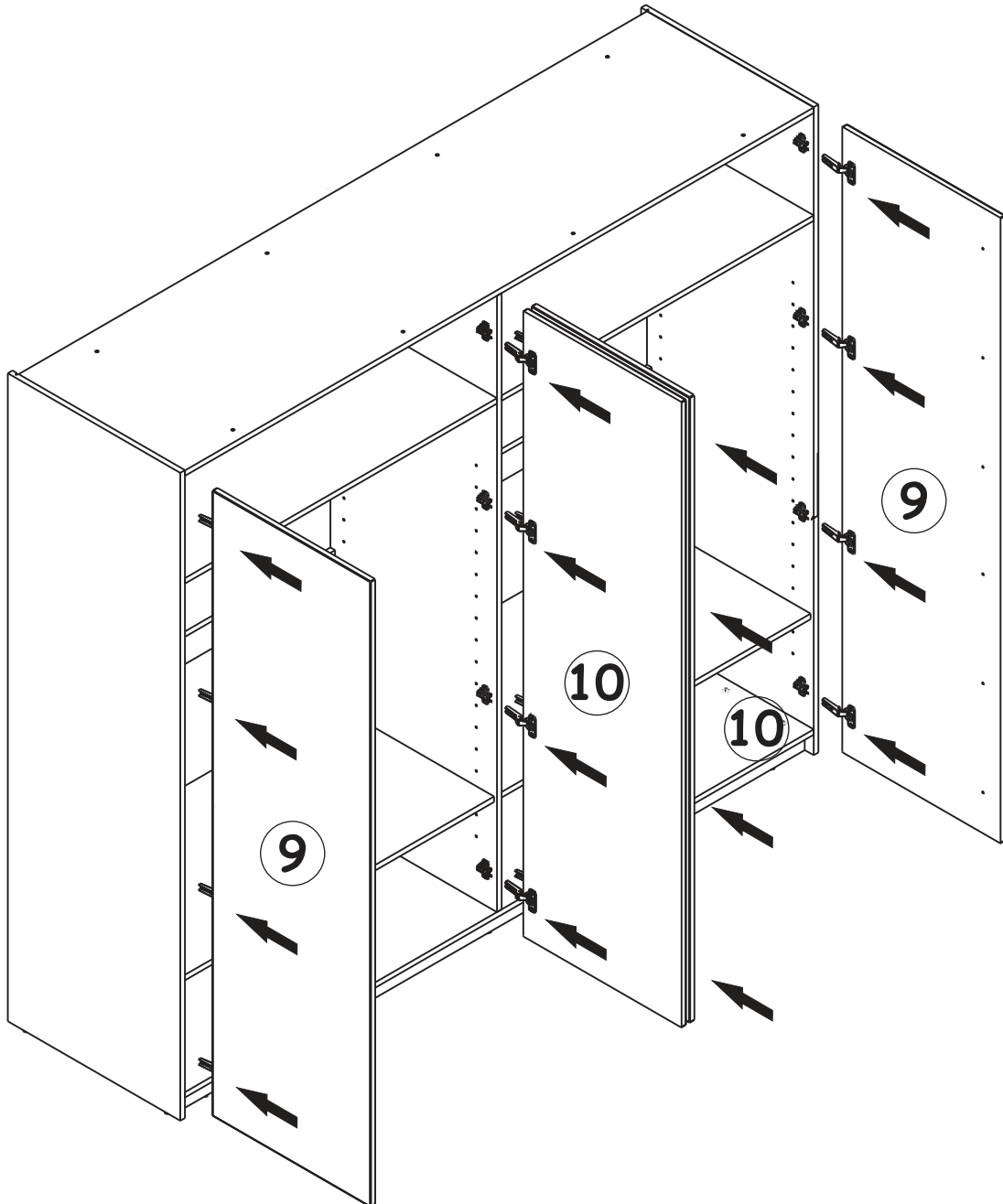

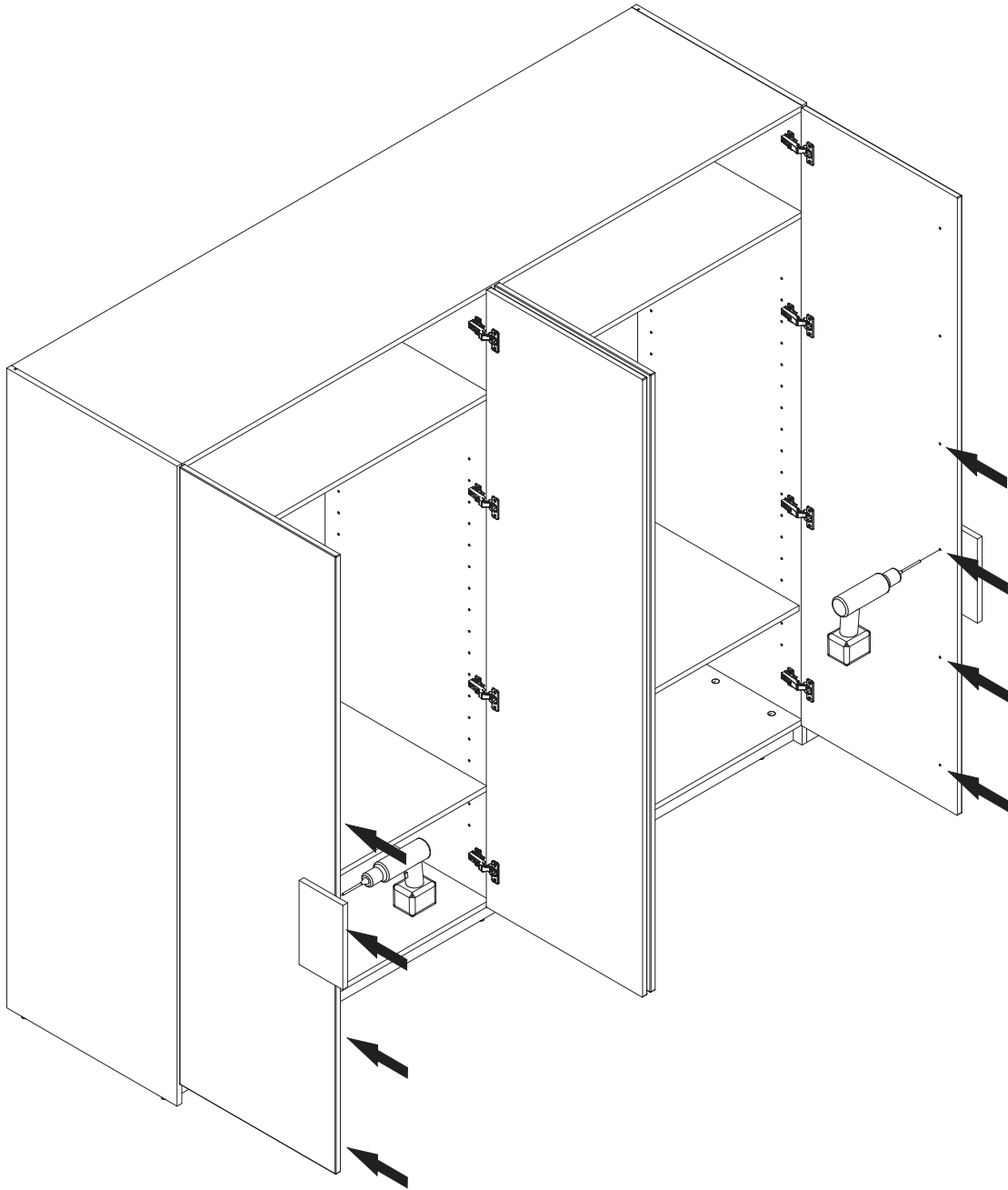

WARDROBE 4DR

20

D6	USØ9/64"x1 3/16"	T03	L-38 37/64"
x8	USØ3,5x30	x2	L-980mm

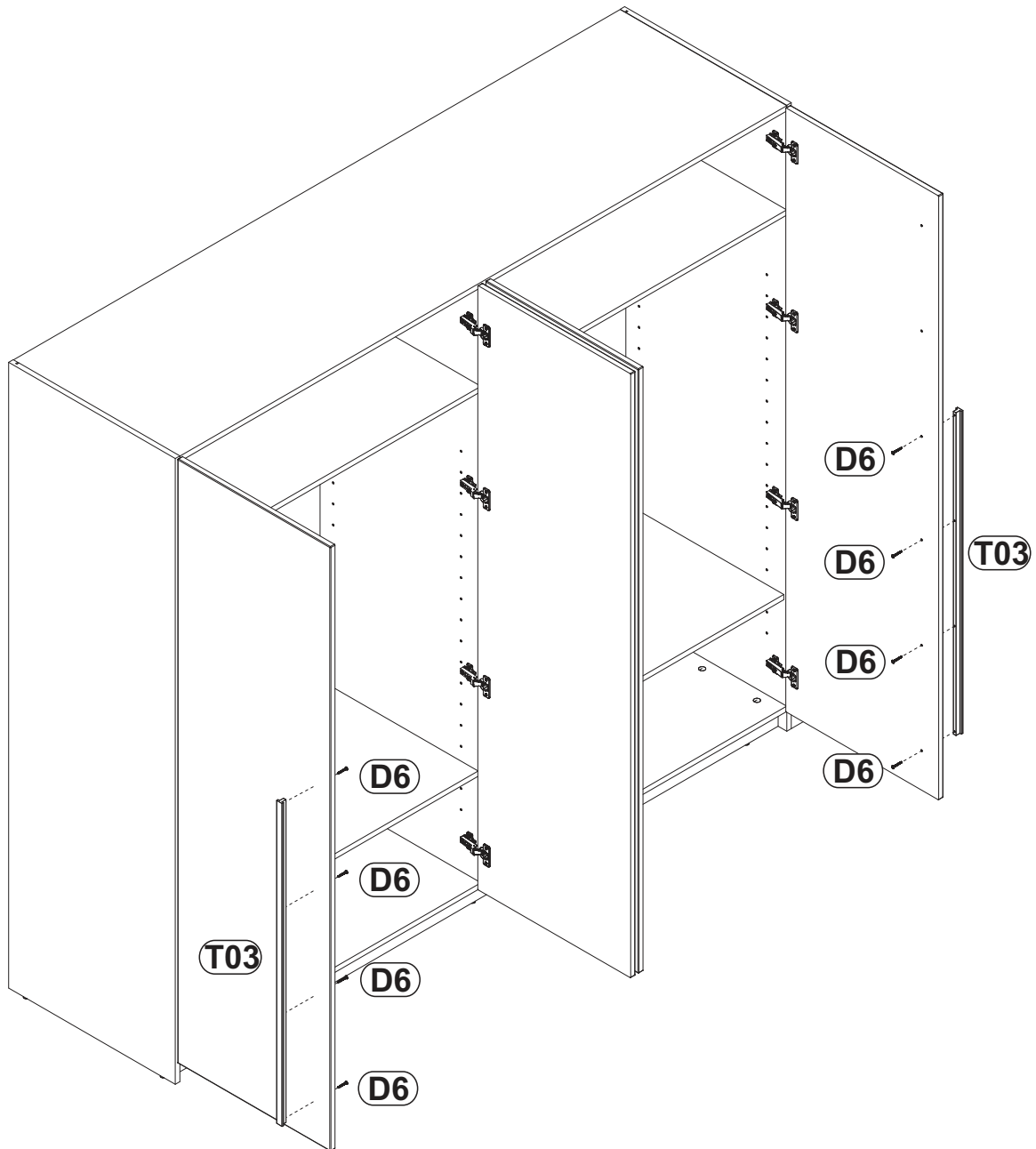

D6	T03	D6	T03