

# SIDEBOARD 3DR

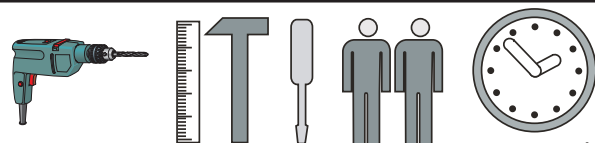

180 min

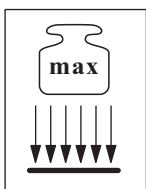

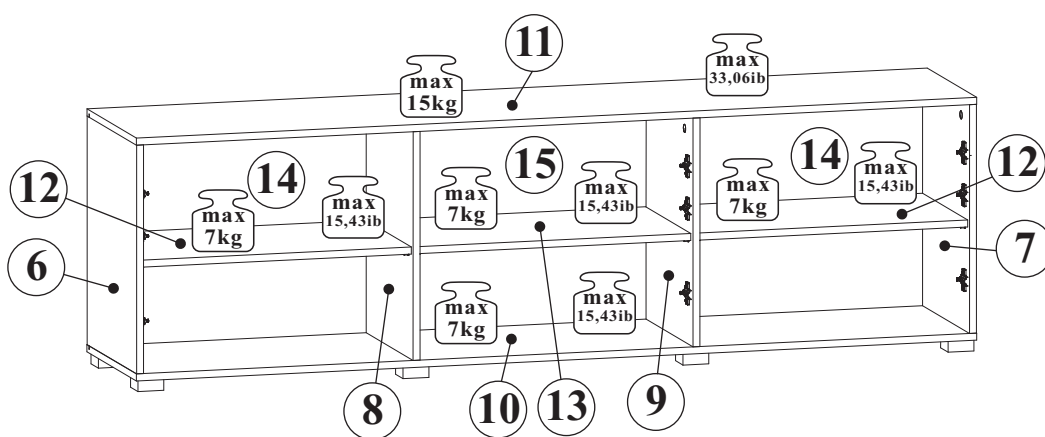
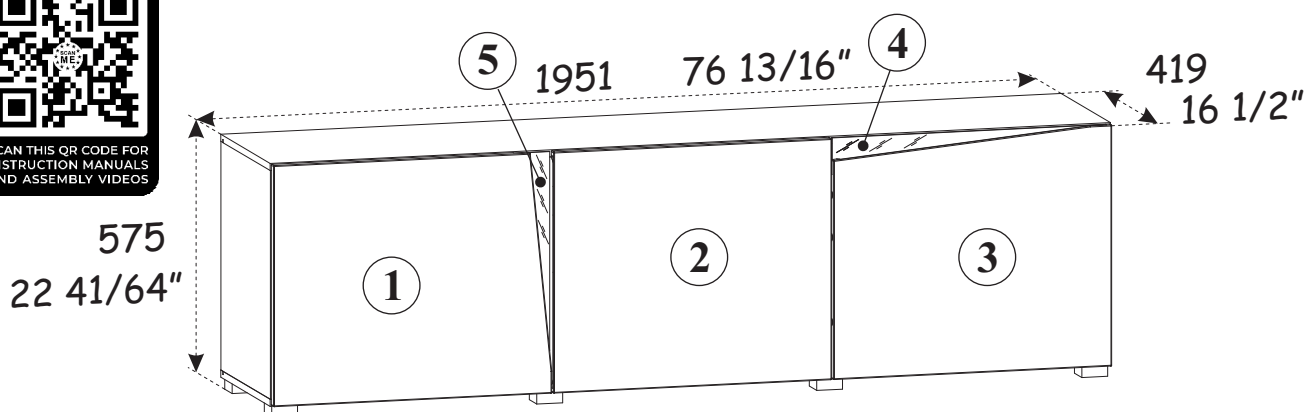

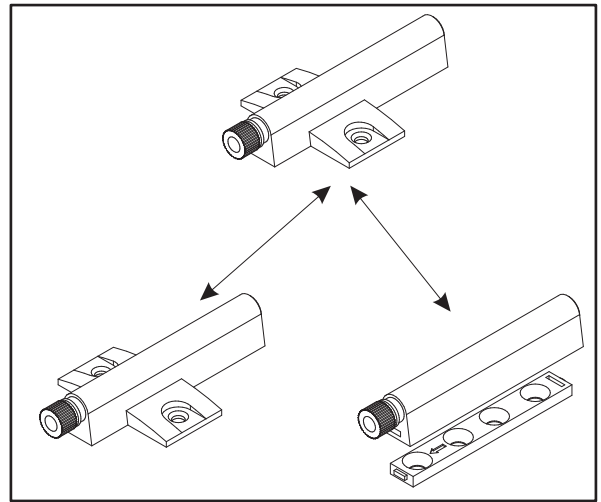
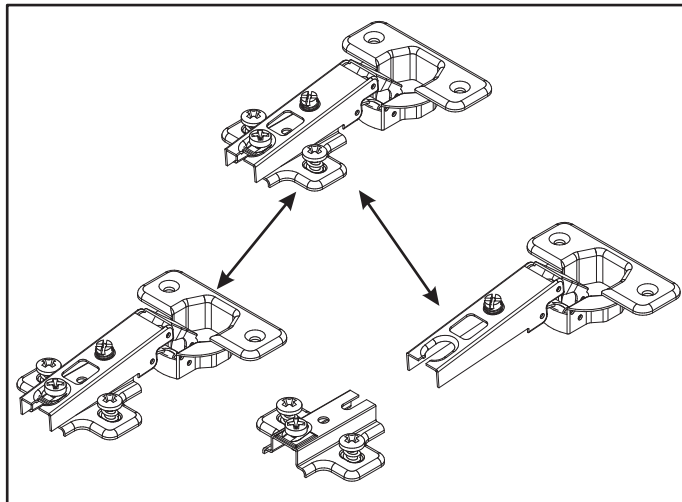
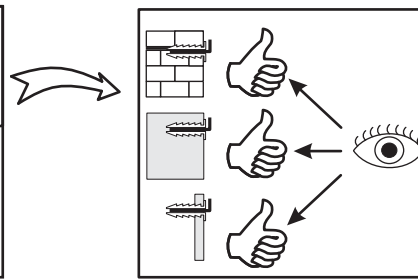
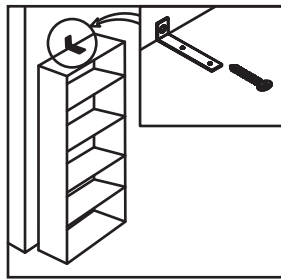
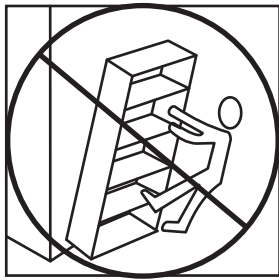
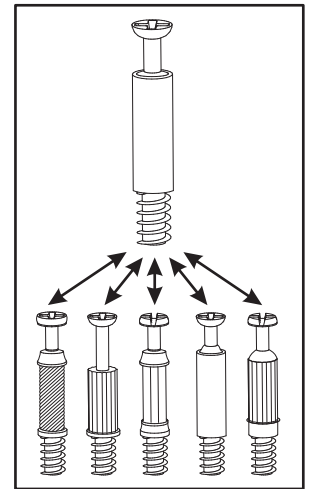
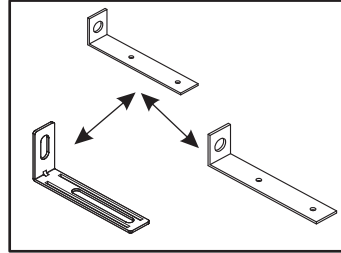
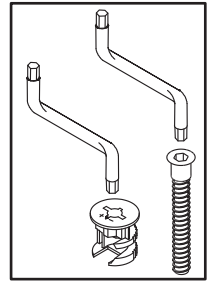
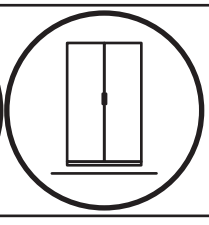
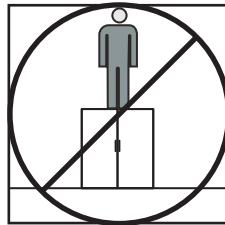
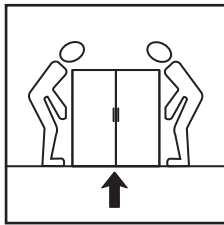
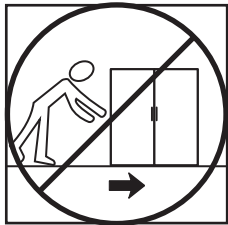
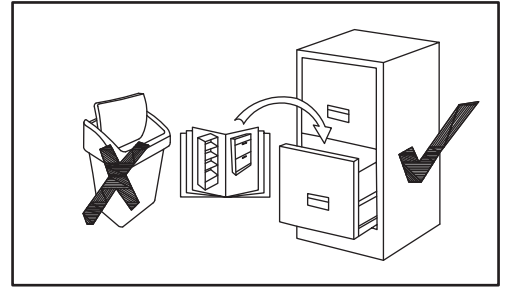
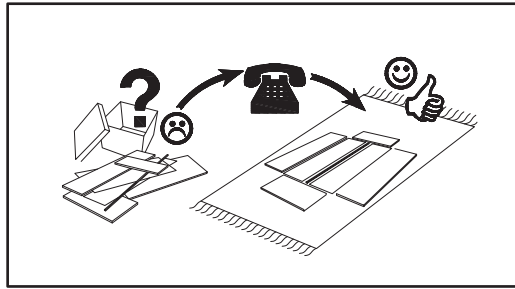
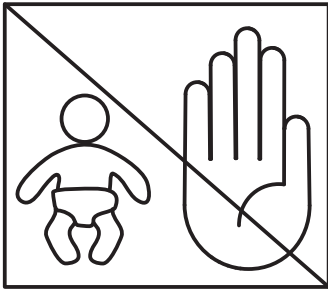
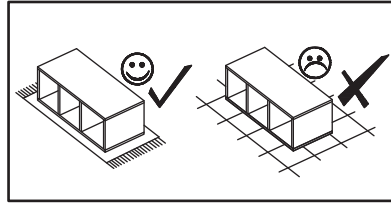
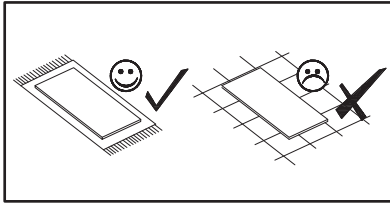

NO	Dim.			Col.-No	Qty
1	646	546	19	1	1
2	646	546	19	1	1
3	646	546	19	1	1
4	644	83	16	1	1
5	544	83	16	1	1
6	518	400	16	2	1
7	518	400	16	2	1
8	518	380	16	1	1
9	518	380	16	2	1
10	1951	400	16	2	1
11	1951	400	16	2	1
12	626	365	16	1	2
13	633	365	16	1	1
14	530	640	3	1	2
15	530	649	3	1	1

NO	Inch			Col.-No	Qty
1	25 7/16	21 1/2	3/4	1	1
2	25 7/16	21 1/2	3/4	1	1
3	25 7/16	21 1/2	3/4	1	1
4	25 23/64	3 17/64	5/8	1	1
5	21 27/64	3 17/64	5/8	1	1
6	20 25/64	15 3/4	5/8	2	1
7	20 25/64	15 3/4	5/8	2	1
8	20 25/64	14 61/64	5/8	1	1
9	20 25/64	14 61/64	5/8	2	1
10	76 13/16	15 3/4	5/8	2	1
11	76 13/16	15 3/4	5/8	2	1
12	24 41/64	14 3/8	5/8	1	2
13	24 59/64	14 3/8	5/8	1	1
14	20 55/64	25 13/64	1/8	1	2
15	20 55/64	25 35/64	1/8	1	1

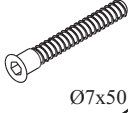
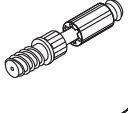
# SIDEBOARD 3DR

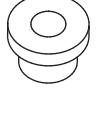
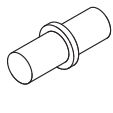
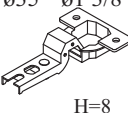
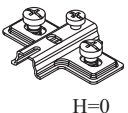
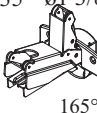
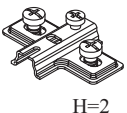
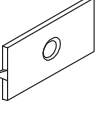

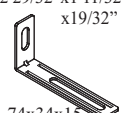
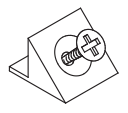
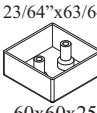
# SIDEBOARD 3DR

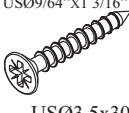
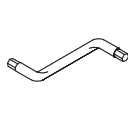
<b>A1</b> x16	ø5/16"x1 27/64"  ø8x36	<b>B11</b> x8	ø9/32"x1 31/32"  Ø7x50	<b>B4</b> x8		<b>B5</b> x8	ø19/32"x15/32"  ø15x12	<b>G5</b> x8		<b>P2</b> x6	
<b>G7</b> x12		<b>E23</b> x3	ø35 ø1 3/8"  H=8	<b>E2</b> x3	 H=0	<b>E33</b> x6	ø35 ø1 3/8"  165°	<b>E4</b> x6	 H=2	<b>G16</b> x8	
<b>KR5</b> SFXP x2	Ø 25/64"x1 31/32 x2 23/64  Ø10/50x60	<b>L1</b> x2	2 29/32"x1 11/32" x19/32"  74x34x15	<b>S1</b> x24		<b>ST21</b> x8	2 23/64"x 2 23/64"x63/64"  60x60x25	<b>D10</b> x22	USØ9/64"x33/64"  USØ3,5x13	<b>UP13</b> x14	UPØ1/8"x5/8"  UPØ3x16
<b>D6</b> x16	USØ9/64"x1 3/16"  USØ3,5x30	<b>G2</b> x1									

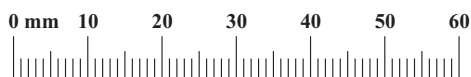
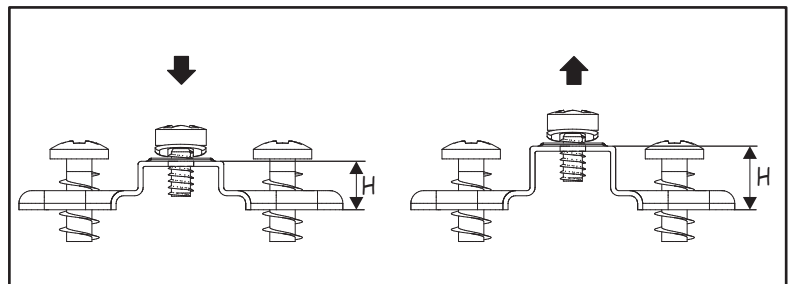
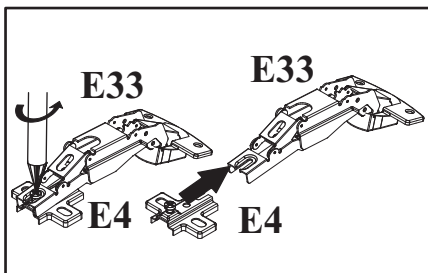
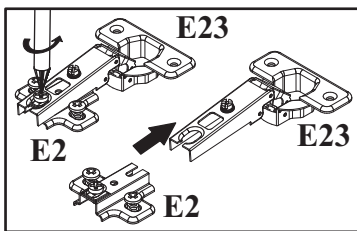

# SIDEBORD 3DR

1

A1	ø5/16"x1 27/64"
x4	ø8x36

G7	
x2	

B5	ø19/32"x15/32"
x2	ø15x12

E4	
x3	H=2

<del>E2</del>	<del></del>
<del>x3</del>	<del>H=0</del>

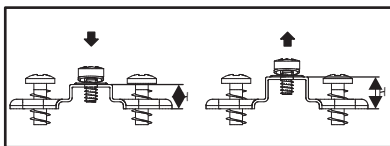
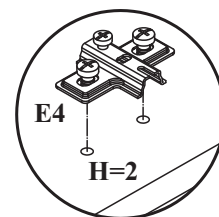
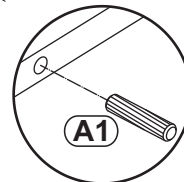
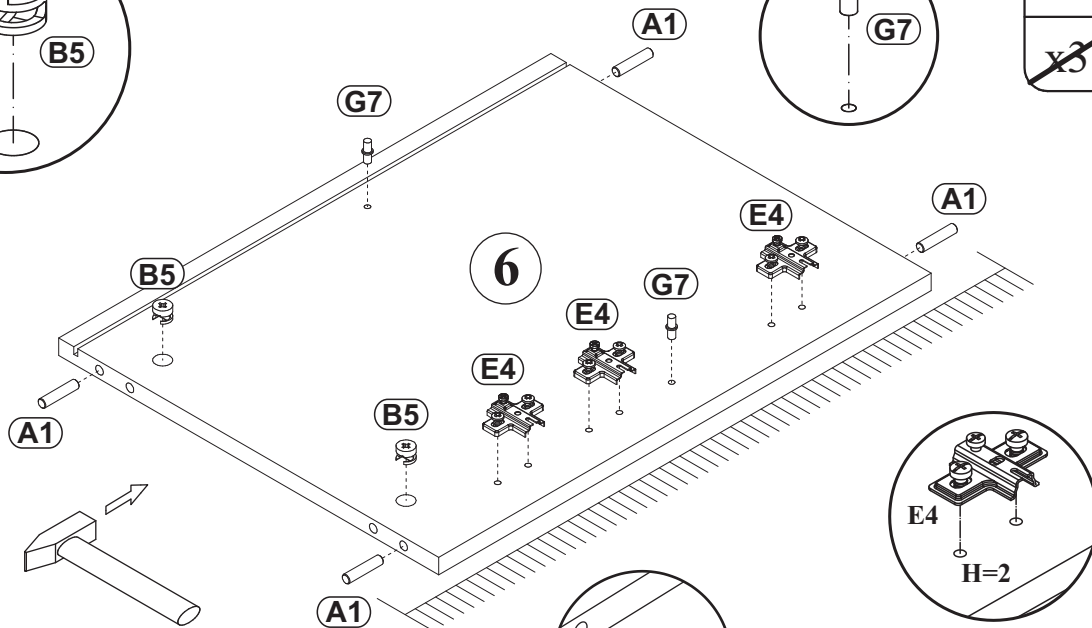
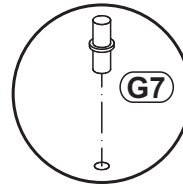
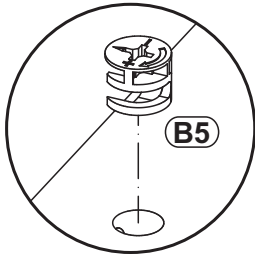

2

A1	ø5/16"x1 27/64"
x4	ø8x36

G7	
x2	

B5	ø19/32"x15/32"
x2	ø15x12

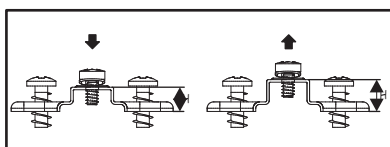
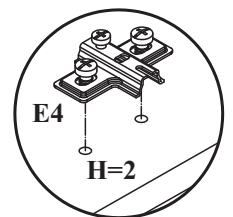
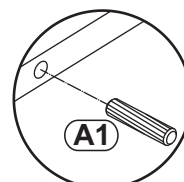
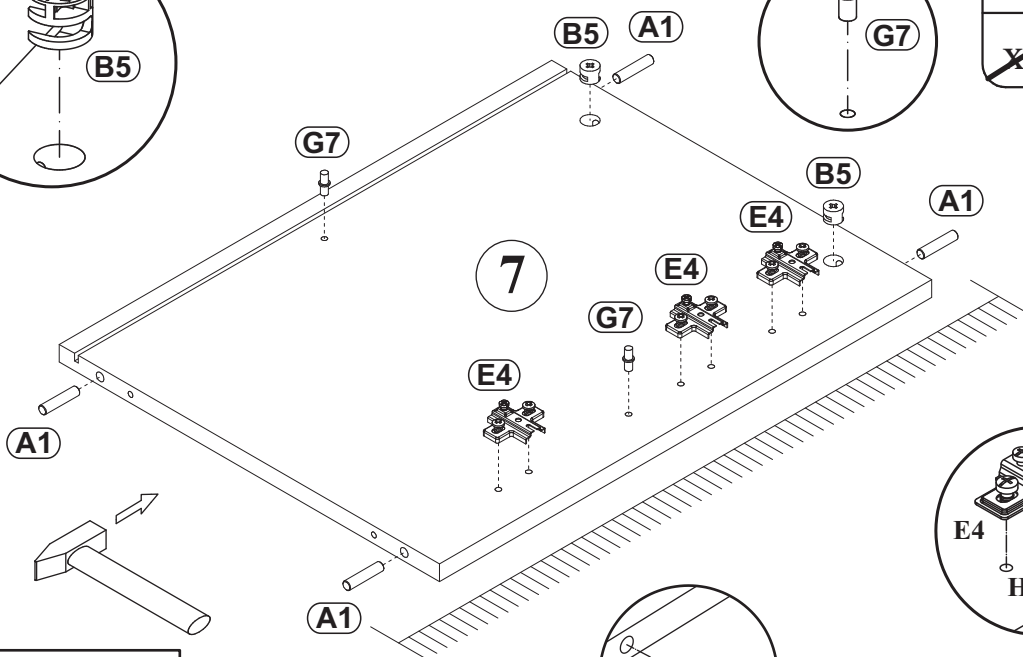
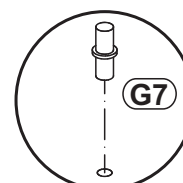
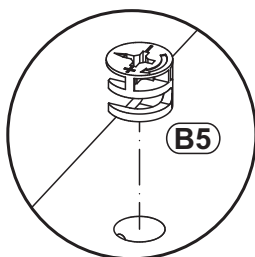

E4	
x3	H=2

<del>E2</del>	<del></del>
<del>x3</del>	<del>H=0</del>



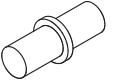

# SIDEBORD 3DR

3

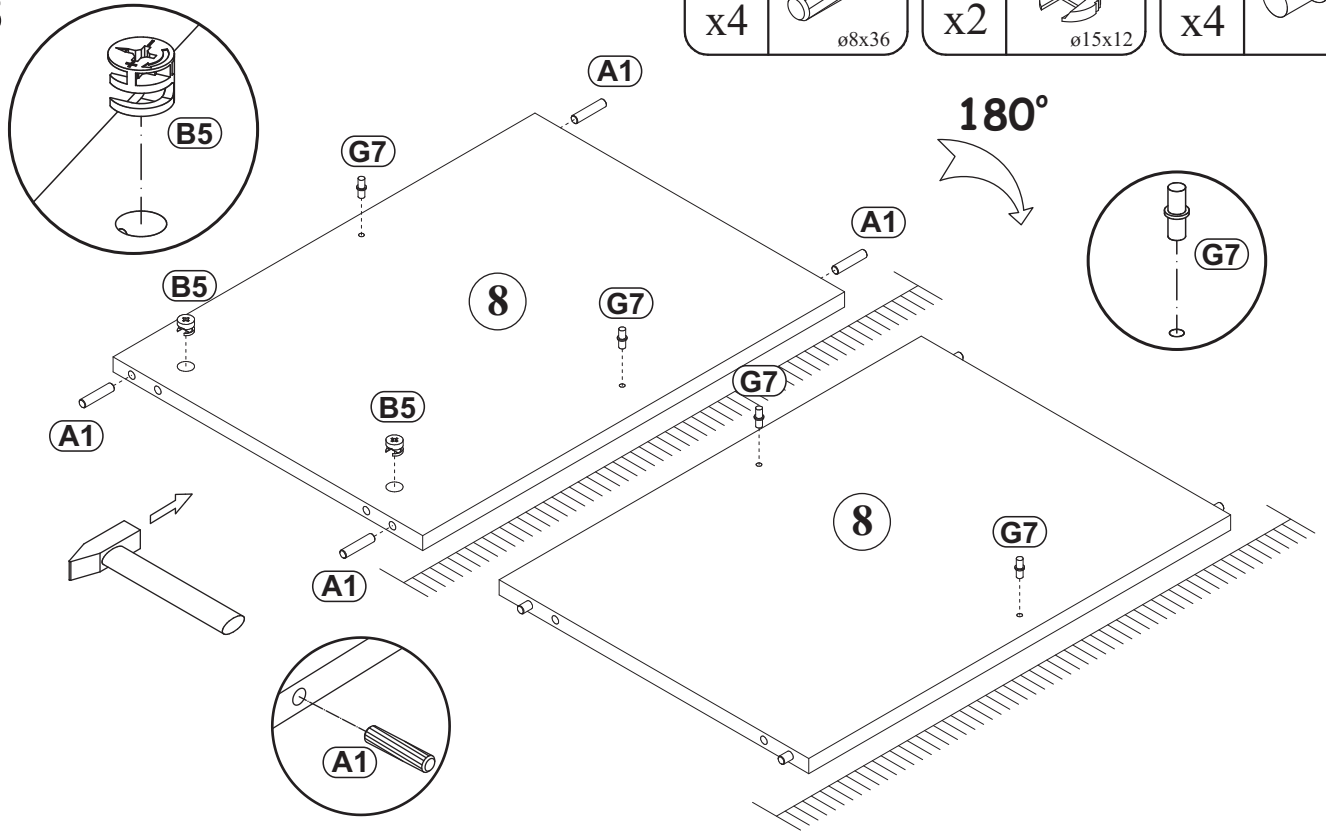
A1	ø5/16"x1 27/64"	B5	ø19/32"x15/32"	G7	
x4	 ø8x36	x2	 ø15x12	x4	

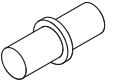

4

A1	ø5/16"x1 27/64"	B5	ø19/32"x15/32"	G7	
x4	 ø8x36	x2	 ø15x12	x4	

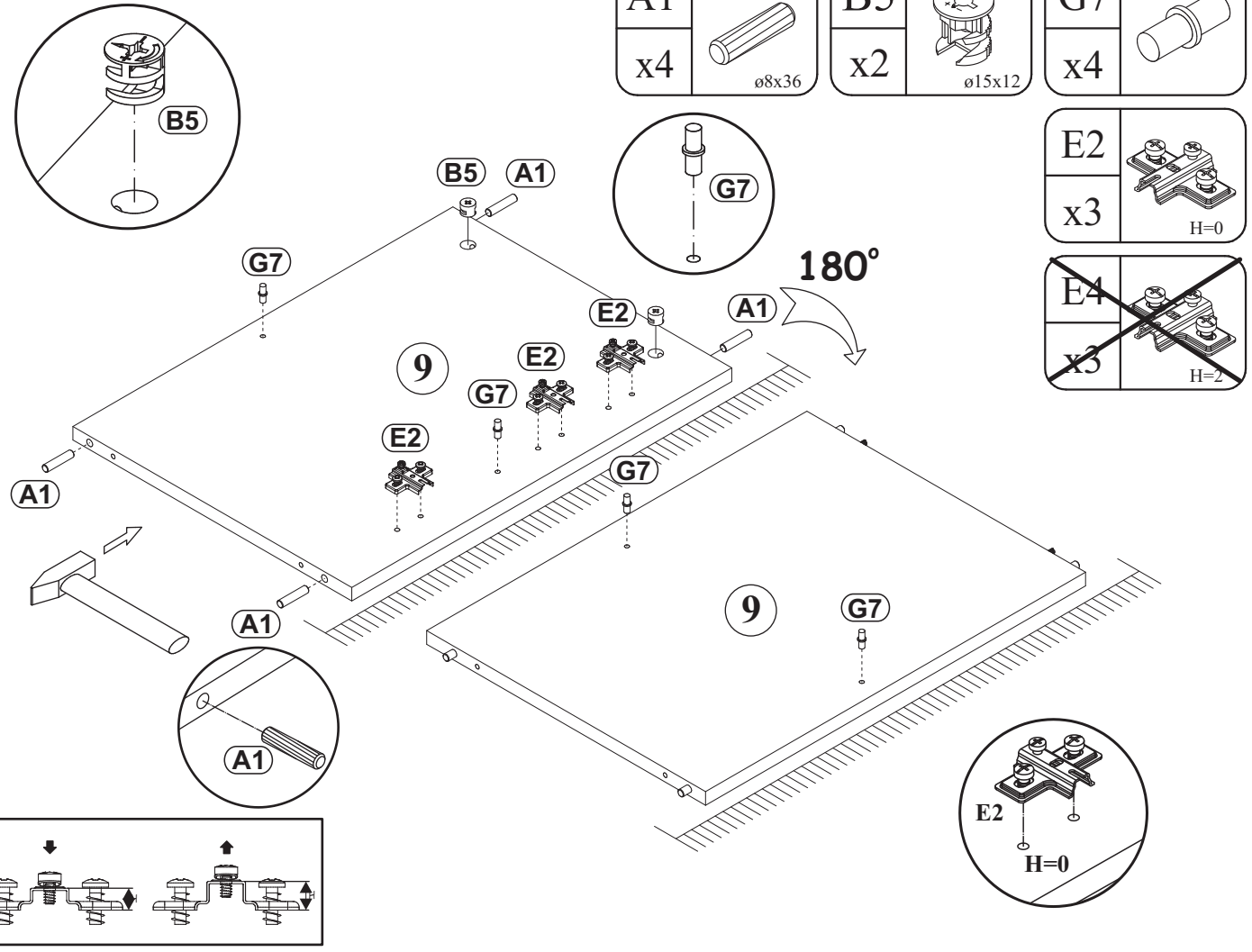

SIDEBORD 3DR

5

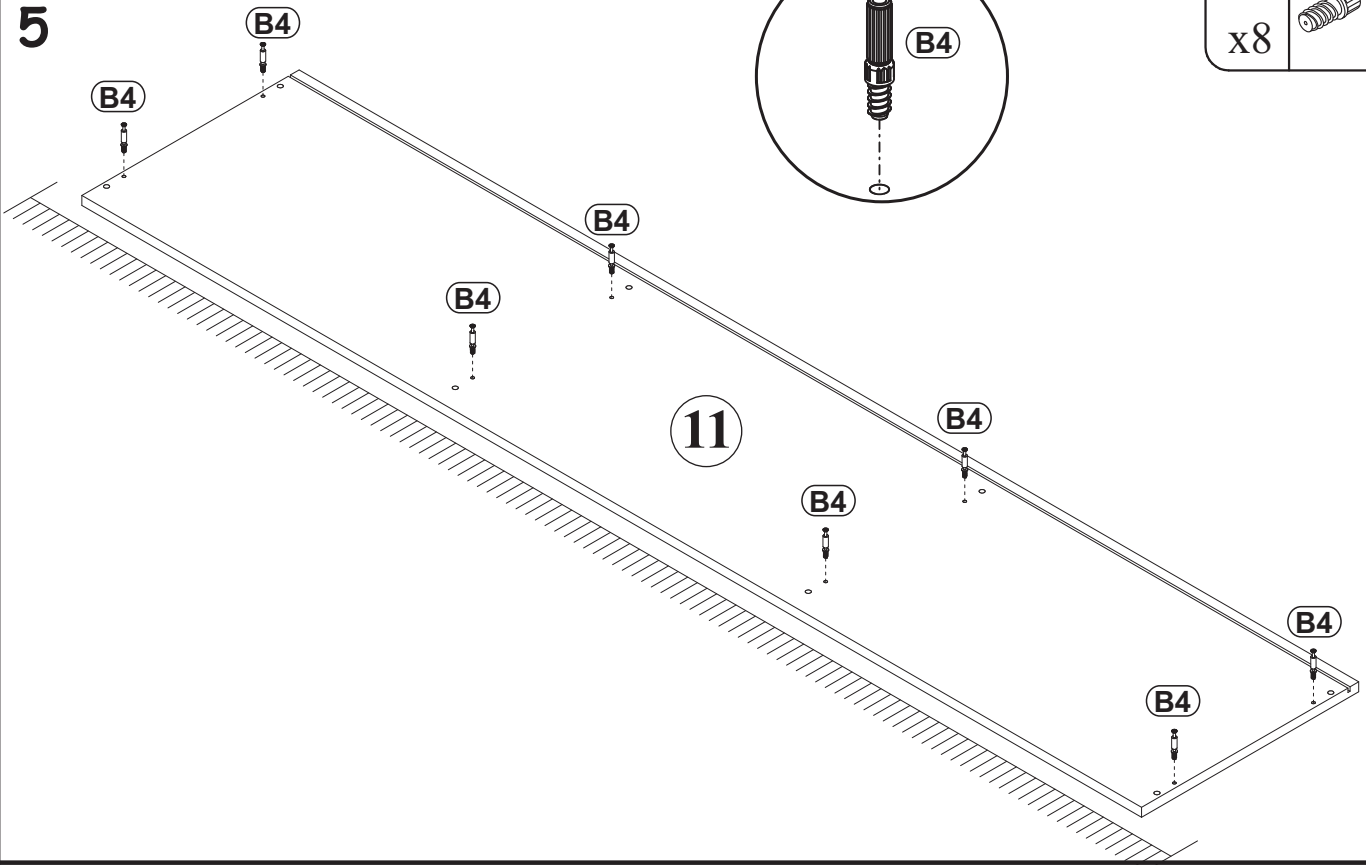

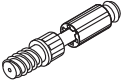
B4	
x8	

6

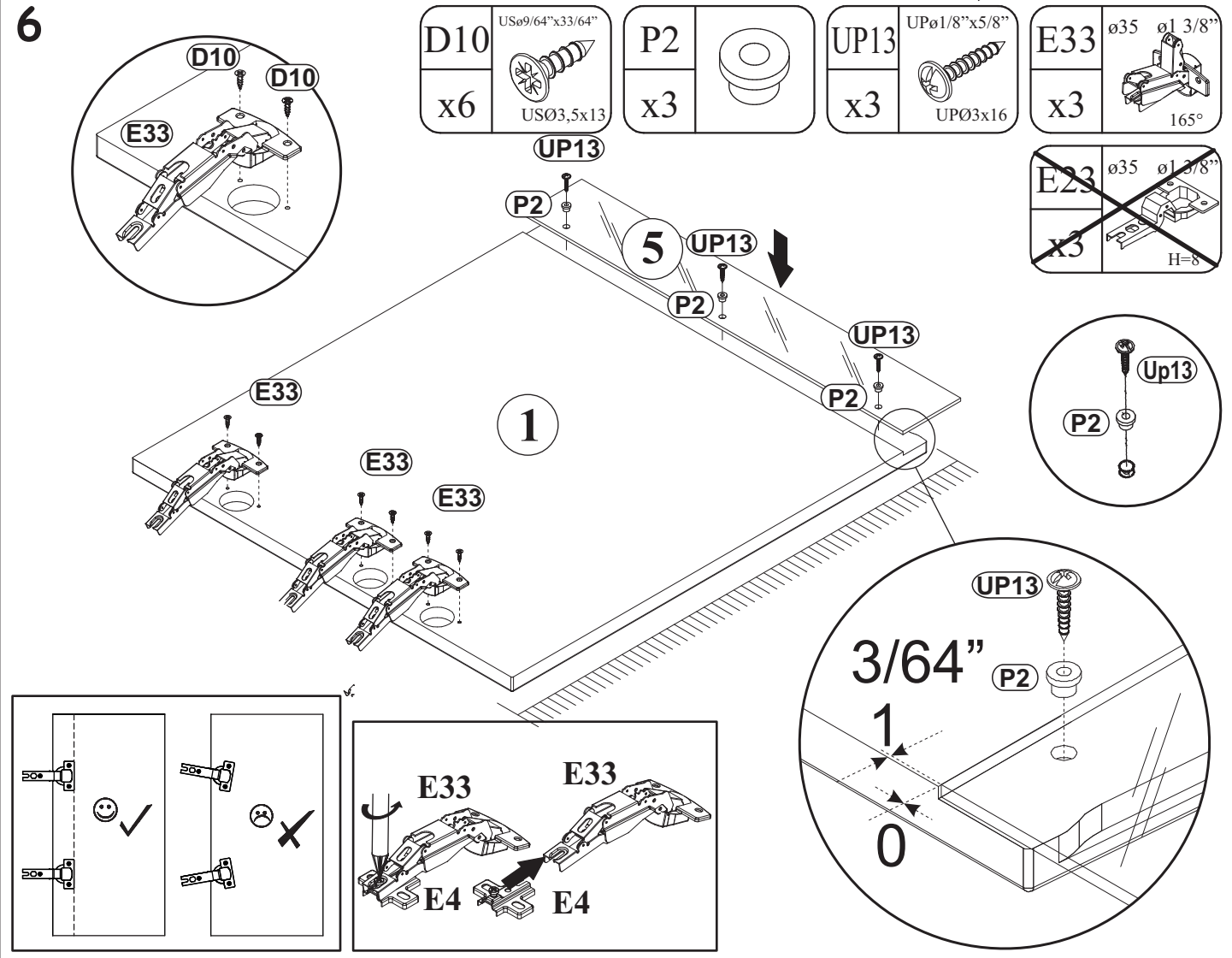

D10	US $\phi$ 9/64"x33/64"
x6	US $\phi$ 3,5x13

P2	
x3	

UP13	UP $\phi$ 1/8"x5/8"
x3	UP $\phi$ 3x16

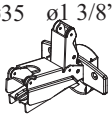
E33	$\phi$ 35 $\phi$ 1 3/8"
x3	 165°

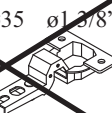
<del>E23</del>	<del><math>\phi</math>35 <math>\phi</math>1 3/8"</del>
<del>x3</del>	<del> H=8</del>

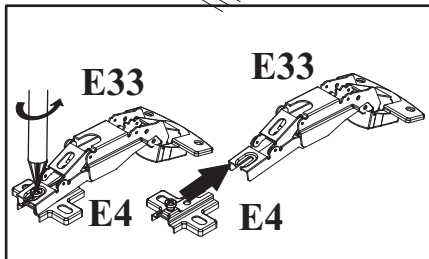
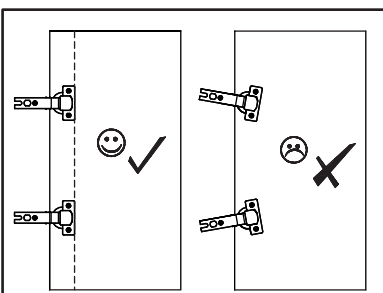
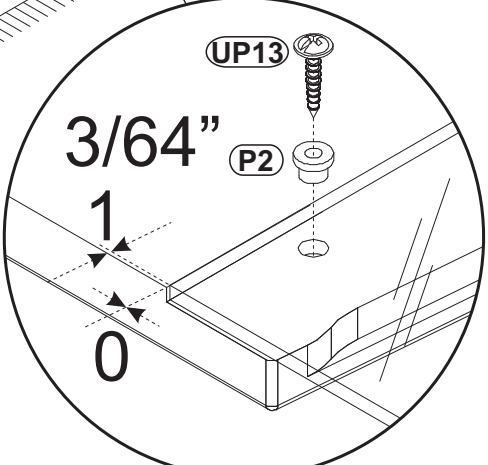
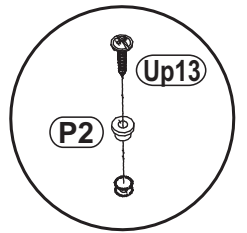

SIDEBOARD 3DR

7

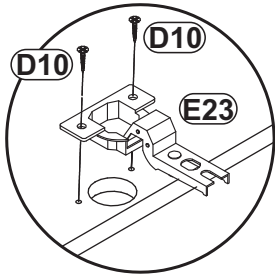

D10	US $\varnothing$ 9/64"x33/64"
x6	US $\varnothing$ 3,5x13

E23	$\varnothing$ 35 $\varnothing$ 1 3/8"
x3	H=8

<del>E33</del>	<del><math>\varnothing</math>35 <math>\varnothing</math>1 3/8"</del>
<del>x3</del>	<del>165</del>

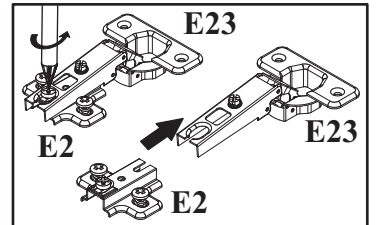
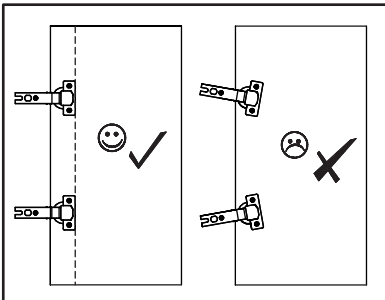
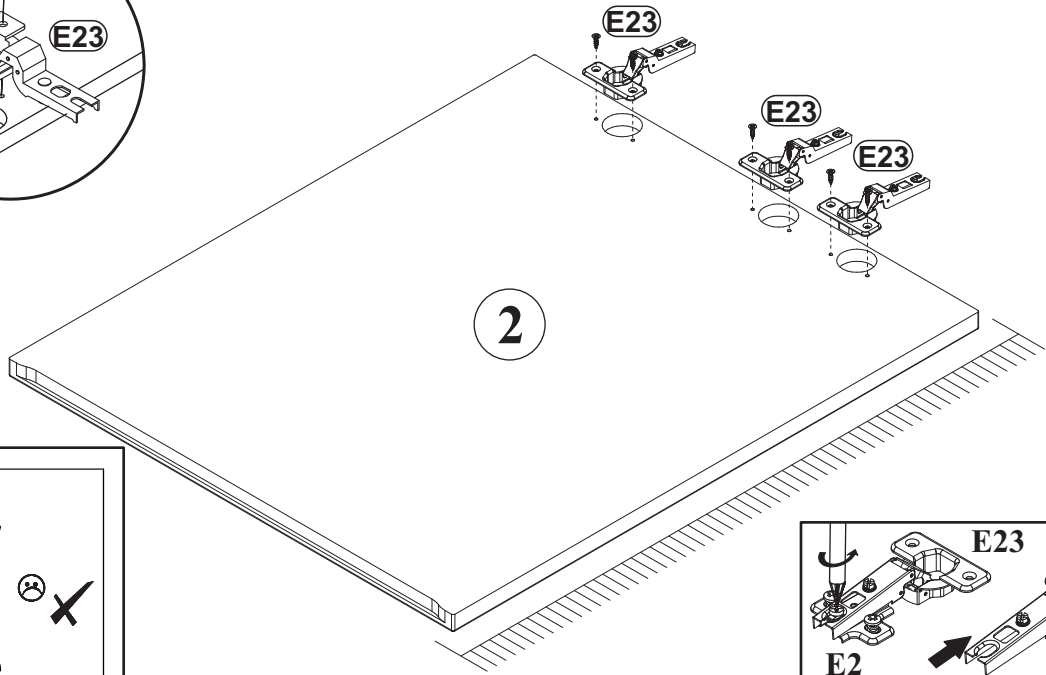

8

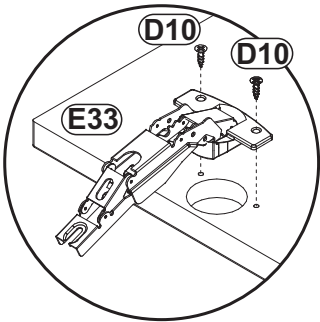

D10	US $\varnothing$ 9/64"x33/64"
x6	US $\varnothing$ 3,5x13

P2	
x3	

UP13	UP $\varnothing$ 1/8"x5/8"
x3	UP $\varnothing$ 3x16

E33	$\varnothing$ 35 $\varnothing$ 1 3/8"
x3	165°

<del>E23</del>	<del><math>\varnothing</math>35 <math>\varnothing</math>1 3/8"</del>
<del>x3</del>	<del>H=8</del>

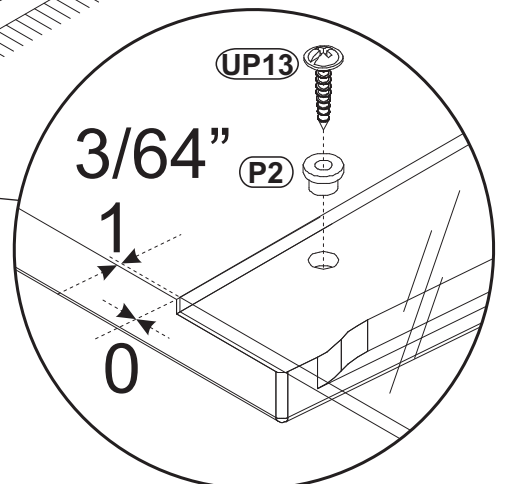
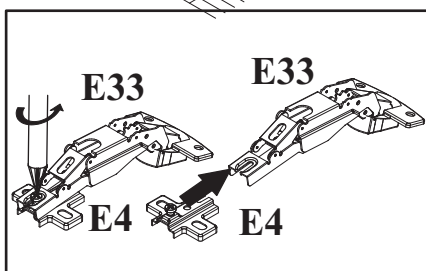
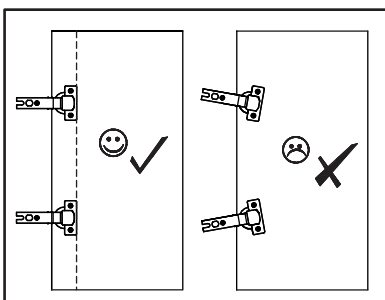
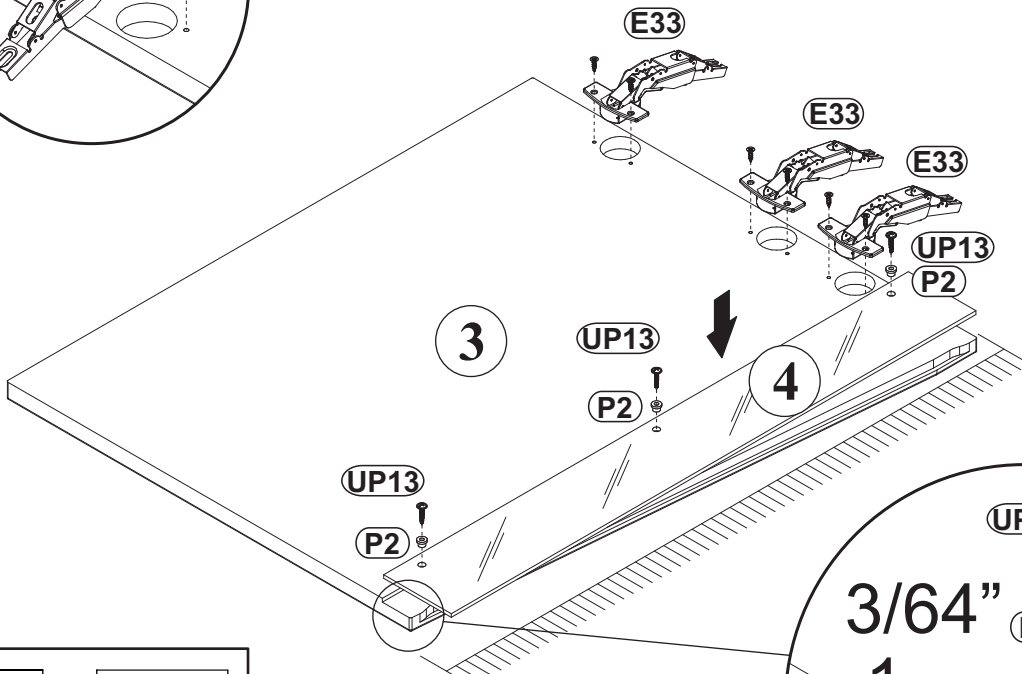

SIDEBOARD 3DR

9

B11	ø9/32"x1 31/32"
x8	 Ø7x50

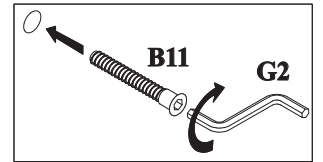
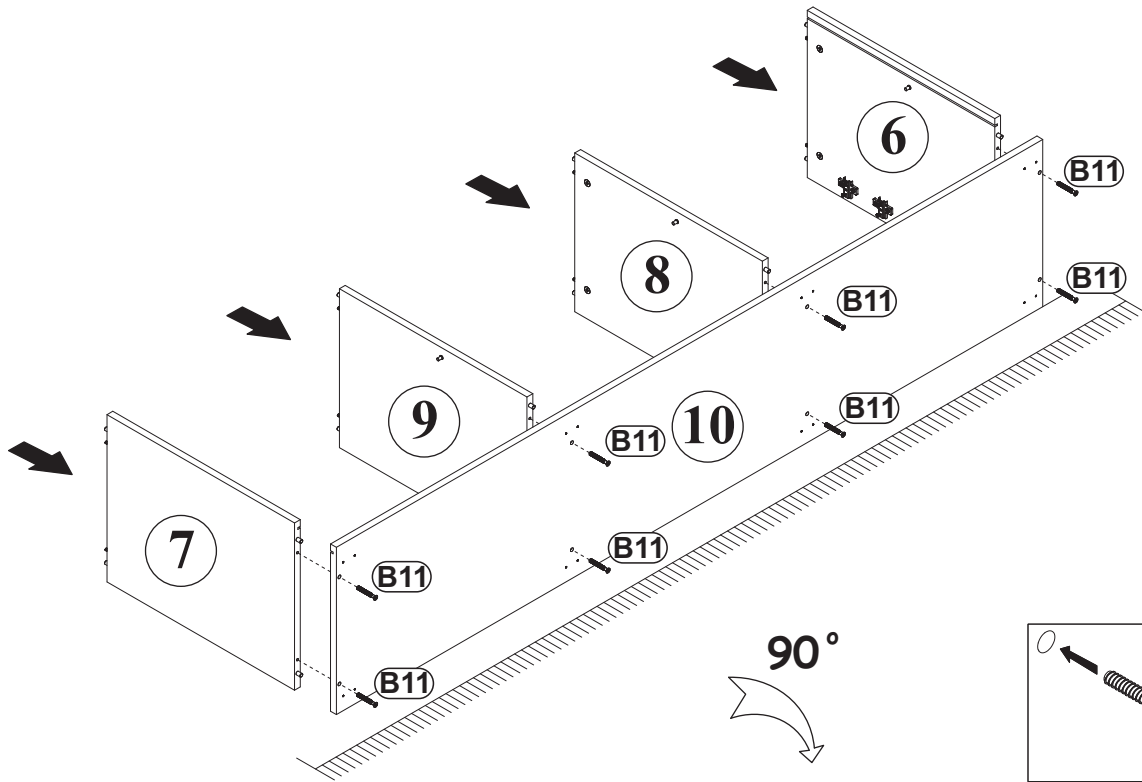

10

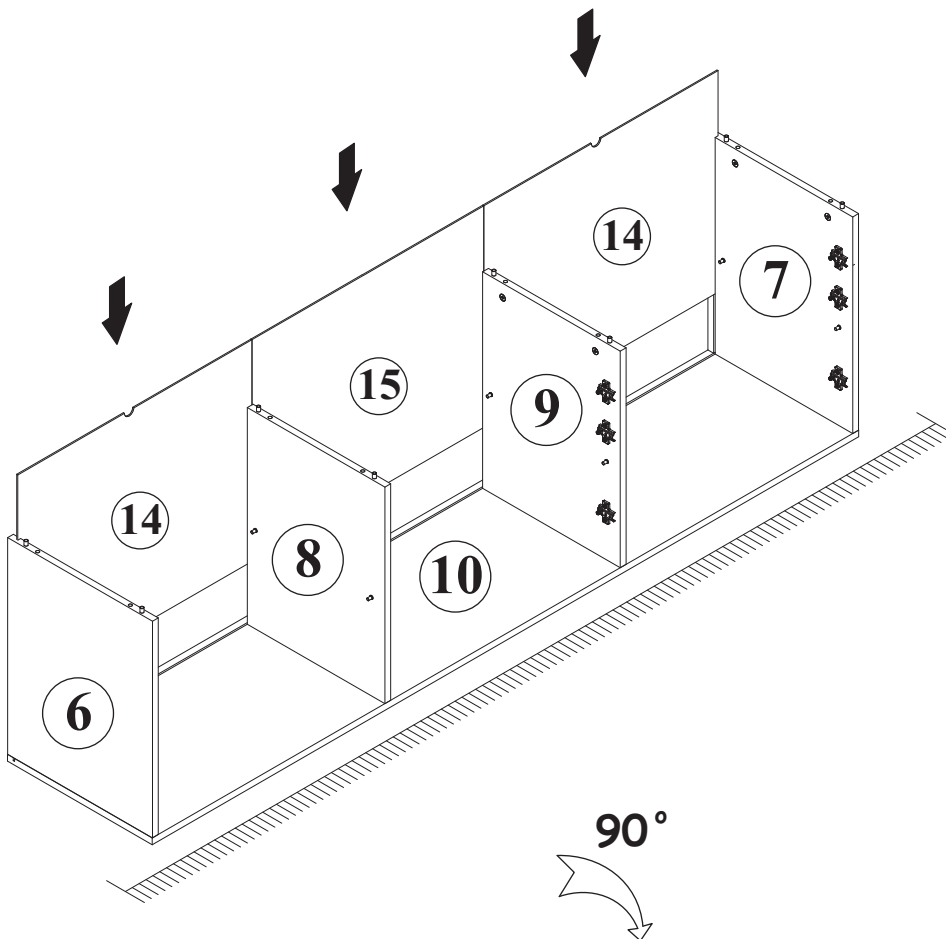



SIDEBOARD 3DR

11

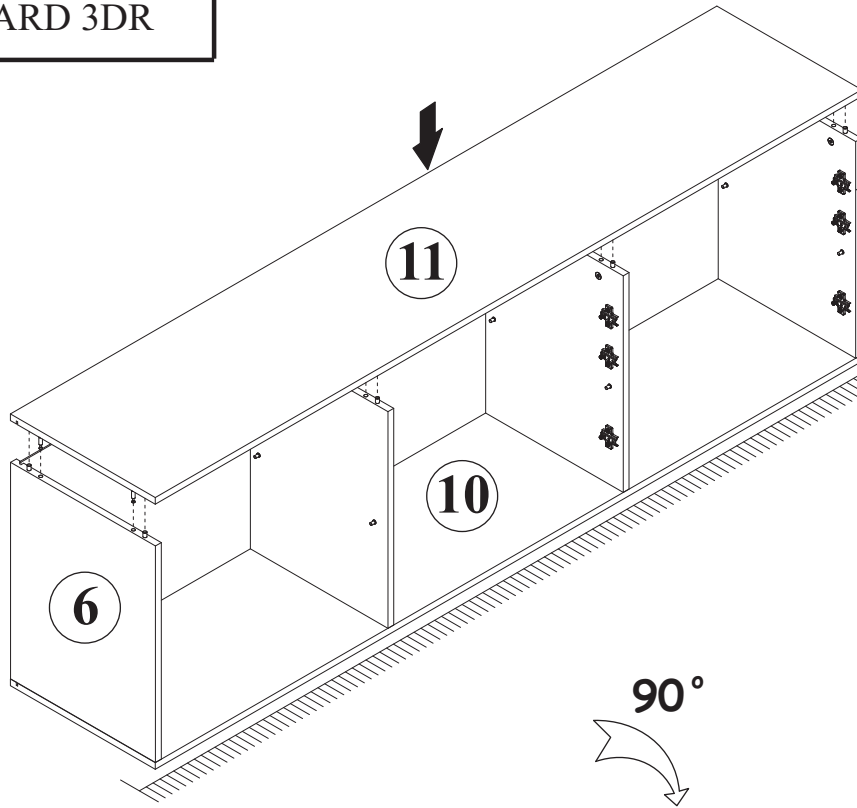

G5	
x8	

12



ST21	2 23/64" x 2 23/64" x 63/64"
x8	 60x60x25

G16	
x8	

UP13	
x8	UPØ3x16

S1	
x24	

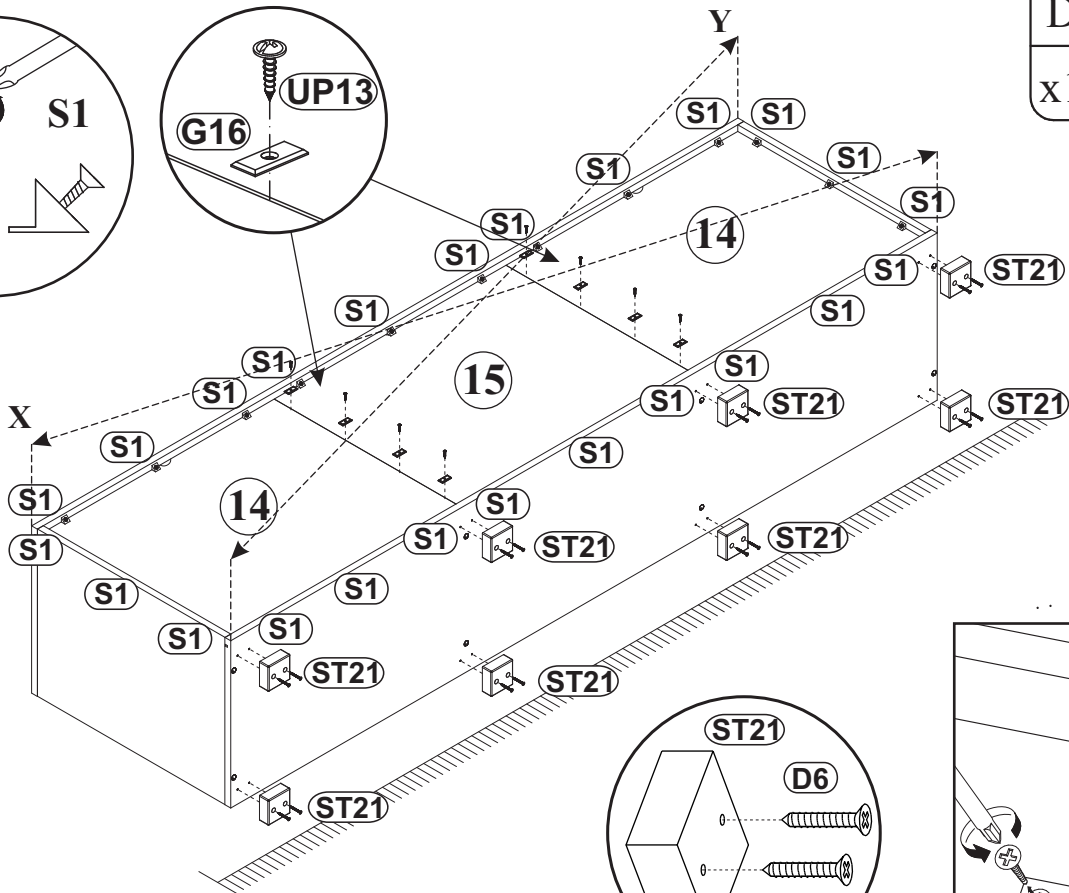
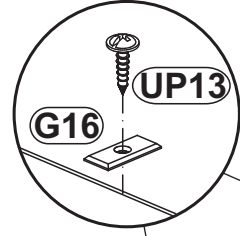
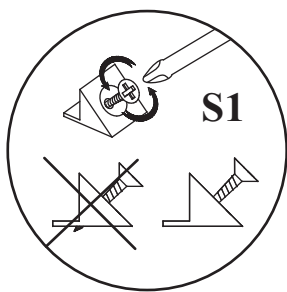

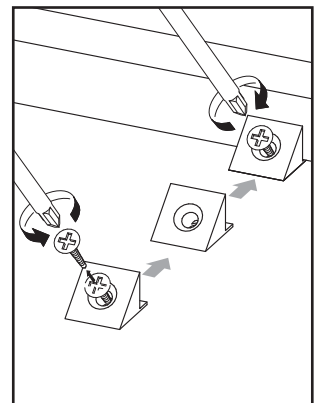
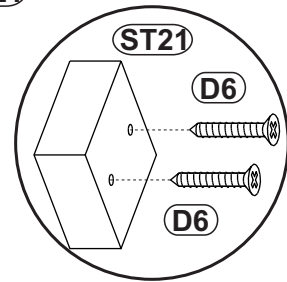

D6	USØ9/64" x 1 3/16"
x16	USØ3,5x30

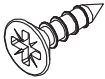

SIDEBOARD 3DR

13

D10	USø9/64"x33/64"
x4	 USØ3,5x13

KR5	Ø 25/64"/1 31/32"
SFXP	x2 23/64"
x2	 Ø10/50x60

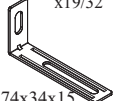
L1	2 29/32"x1 11/32"
x2	x19/32"
	 74x34x15

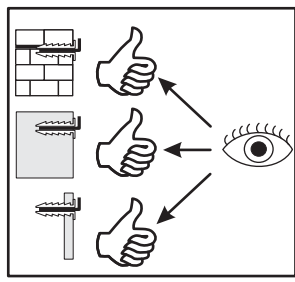
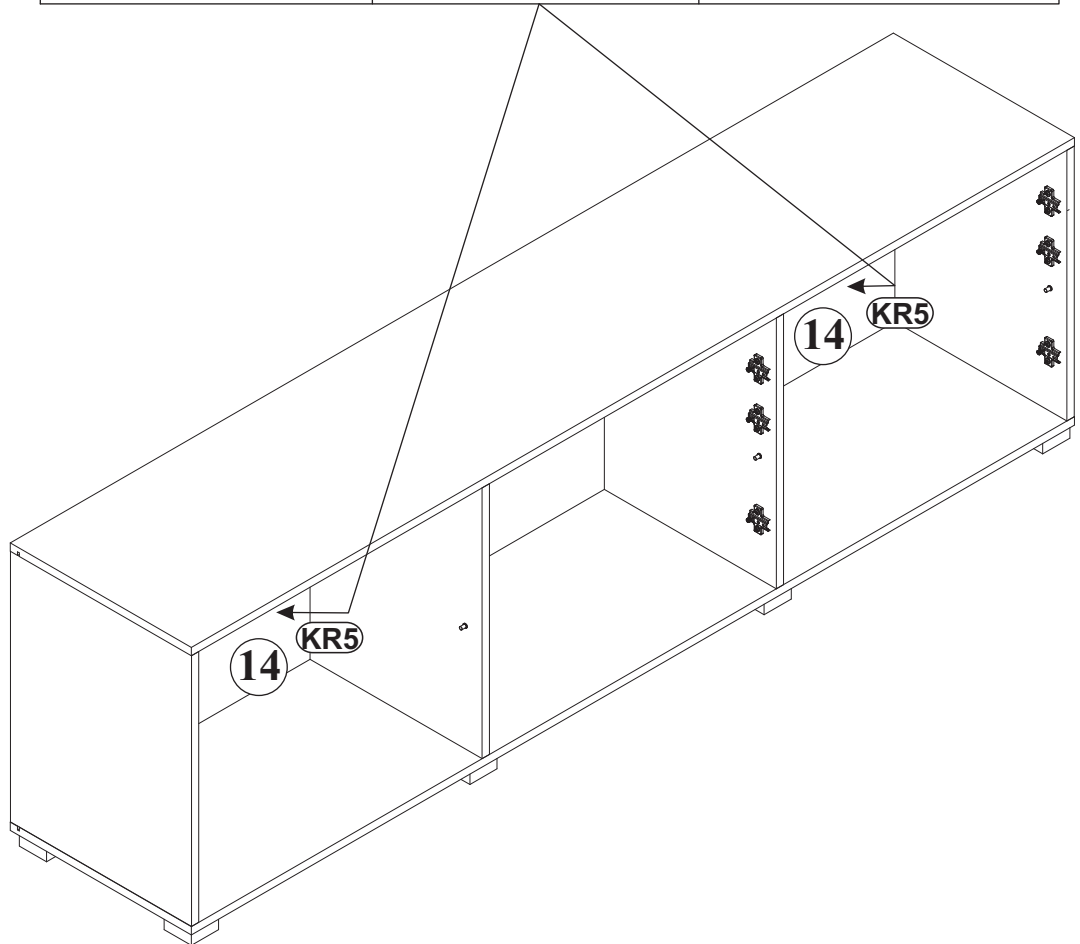
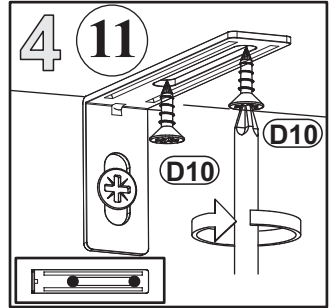
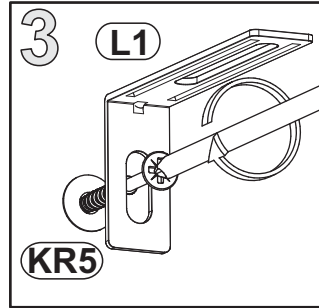
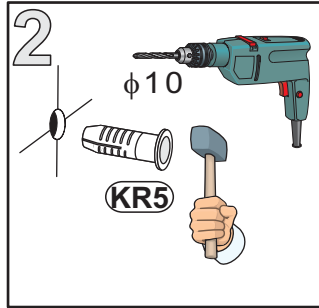
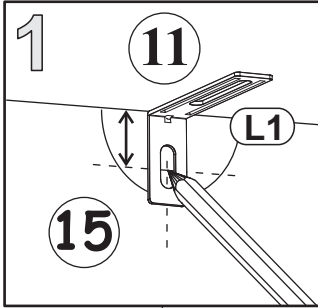

14

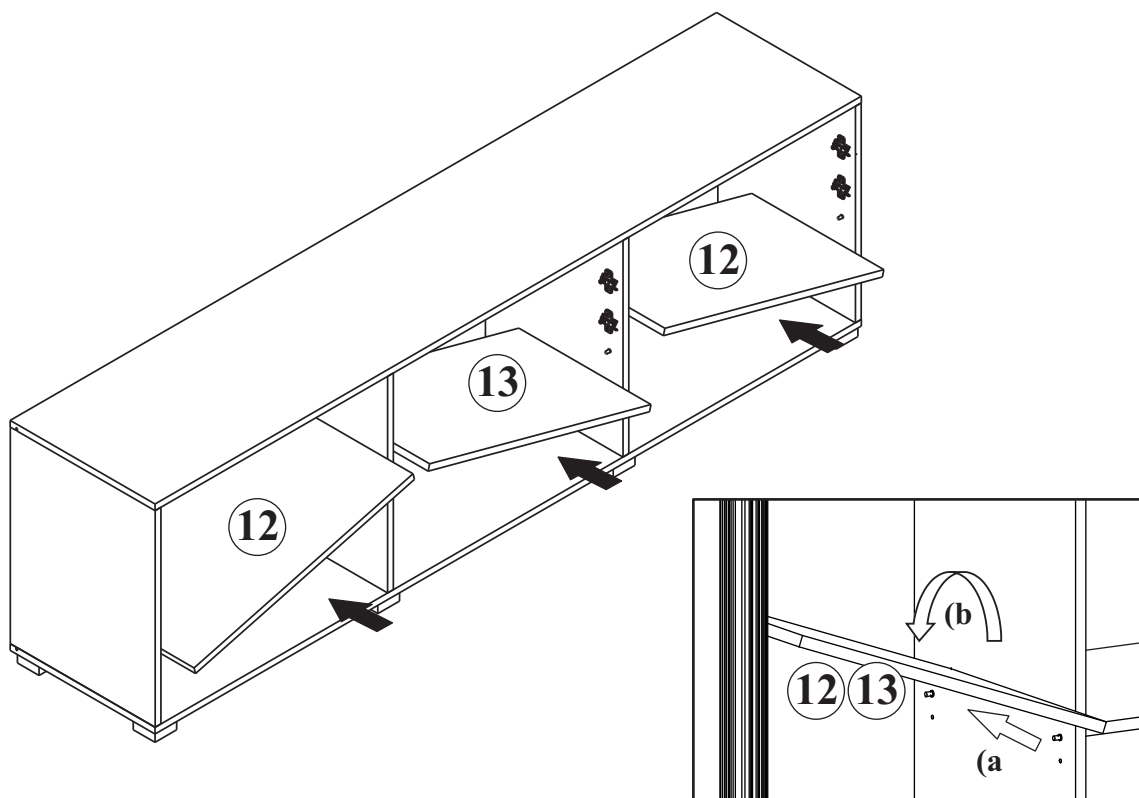

SIDEBOARD 3DR

15

