

DEBORA

DEBORA04

OP-235/236

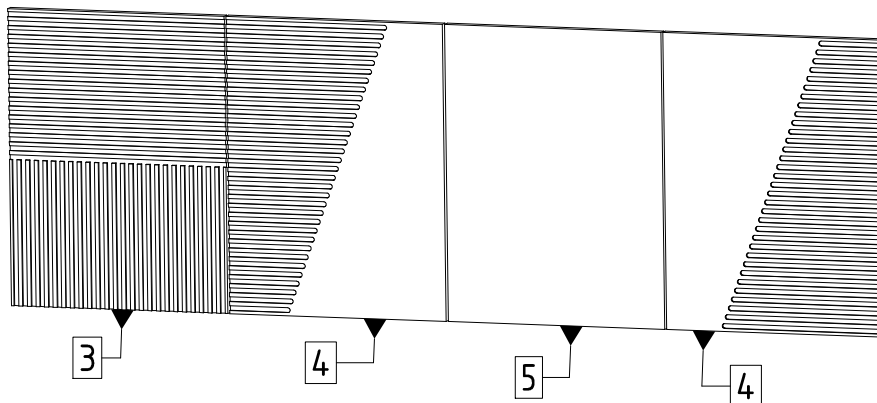
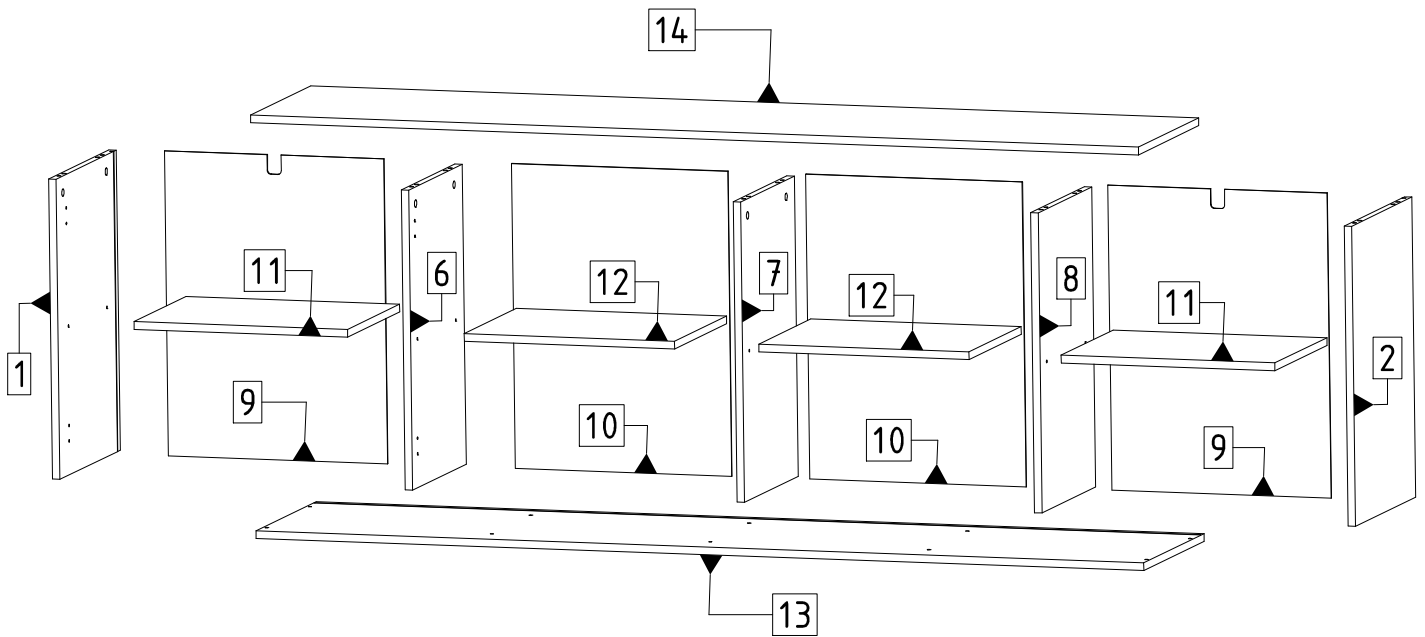
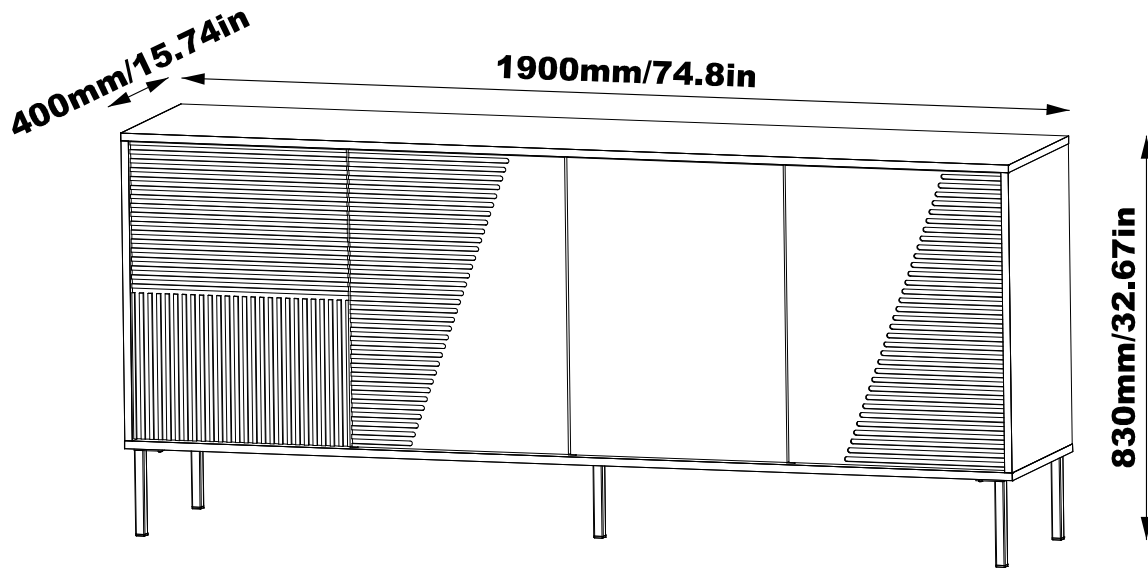
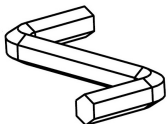
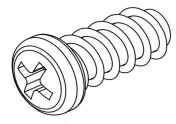
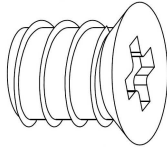
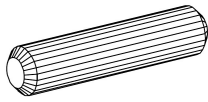
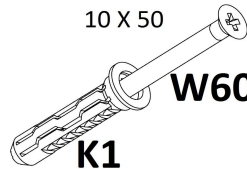

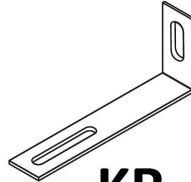

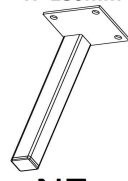
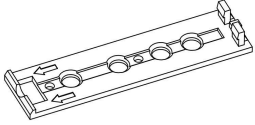
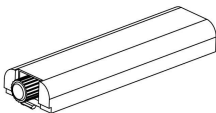
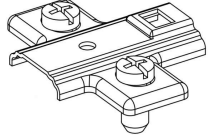
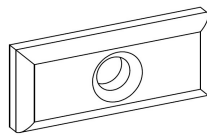
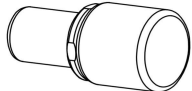
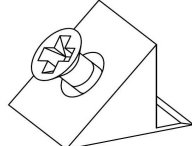
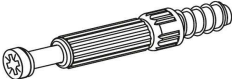
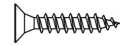
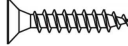
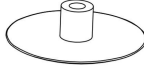
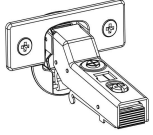
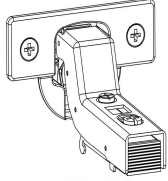
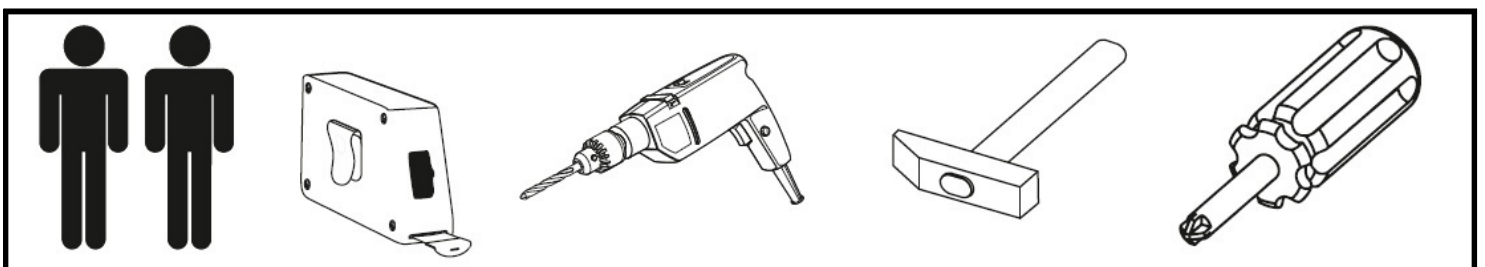

Table accessories

DEBORA04

 A1	6,3 X 13  E13	6,3x9mm  E3	8 x 30  K	10 X 50  W60 K1
 KN	 KR	15 x 12  M	H=180mm  NZ	 OB
 OB2	 PE	 PL	 PP3	 ST
6 x 34 mm  T	4 x 16  W16	3 x 16mm  W3	 Z	 ZPPH
 ZPWH				



Elements				Accessories	
SYMBOL	LENGTH	WIDTH	QUANTITY	SYMBOL	QUANTITY
BL [1]	24.33	15.75	1	A1	1
BP [2]	24.33	15.75	1	E13	15
FT1 [3]	18.23	24.09	1	E3	8
FT2 [4]	18.23	24.09	2	K	10
FT3 [5]	18.23	24.09	1	K1	2
P1 [6]	24.33	14.02	1	KN	10
P2 [7]	24.33	14.02	1	KR	2
P3 [8]	24.33	14.02	1	M	10
PC1 [9]	24.72	18.46	2	NZ_H=180mm	5
PC2 [10]	24.72	18.23	2	OB	4
PK1 [11]	13.62	17.99	2	OB2	4
PK2 [12]	13.62	17.72	2	PE	8
WD [13]	74.8	15.75	1	PL	15
WG [14]	74.8	15.75	1	PP3	16
				ST	20
				T	10
				W16	20
				W3	15
				W60	2
				Z	10
				ZPPH	4
				ZPWH	4

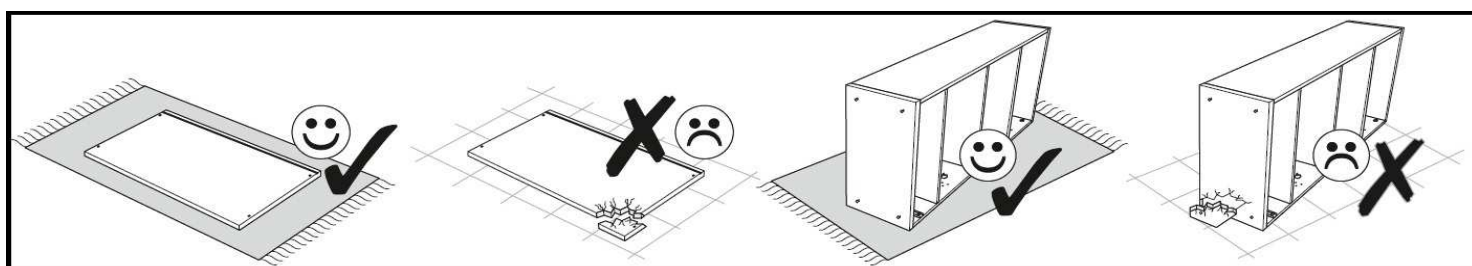

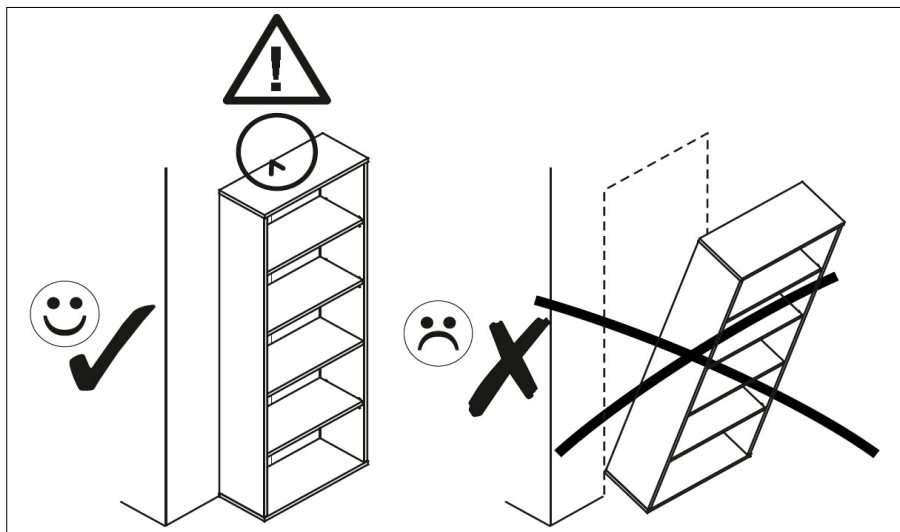

PL
UWAGA! Mebel trzeba trwale zamocować do ściany, aby uniknąć przewrócenia się mebla. W paczce są akcesoria przystosowane wyłącznie do ścian betonowych i z pełnej cegły. Jeśli nie jesteś pewien co do budowy ściany, skonsultuj się ze specjalistą.

EN
ATTENTION! The furniture must be permanently attach to the wall, to avoid falling over furniture. There are accessories in the package adapted only to the walls concrete and solid brick. If you are not sure about the construction walls, consult expert.

IT
NOTA! I mobili devono essere permanenti attaccare al muro, per evitare di cadere mobili. Ci sono accessori nel pacchetto adattato solo alle pareti mattone concreto e solido. se non sei sicuro della costruzione muri, consultare specialista.

D
ACHTUNG! Die Möbel müssen dauerhaft sein an der Wand befestigen, um nicht umzufallen Möbel. Es gibt Zubehör in der Verpackung nur an die Wände angepasst Beton und Vollziegel. wenn Sie sind sich nicht sicher über die Konstruktion Wände konsultieren Spezialist.

ES
NOTA! La pieza necesita ser permanentemente pegar a la pared, para evitar caerse muebles. Están en el paquete accesorios adaptados solo para paredes Hormigón y ladrillo macizo. si no estás seguro de la construcción Paredes, consultar a un especialista.

FR
REMARQUE! La pièce doit être en permanence attacher au mur, pour éviter de tomber meubles. Ils sont dans le paquet accessoires adaptés seulement pour les murs béton et brique pleine. si vous n'êtes pas sûr de la construction murs, consultez un spécialiste.

CZ
POZOR! Kus musí být natrvalo připevnit ke zdi, aby se zabránilo pádu nábytek. Jsou v balení příslušenství přizpůsobené pouze pro stěny betonové a pevné cihly. pokud Nejste si jisti stavbou konzultovat odborníka.

SLO
POZOR! Kus musí byť natrvalo pripojit' k stene, aby sa zabránilo pádu nábytok. Sú v balení príslušenstvo prispôsobené len pre steny betón a pevné tehly. ak Nie ste si istý stavbou konzultujte s odborníkom.

1.

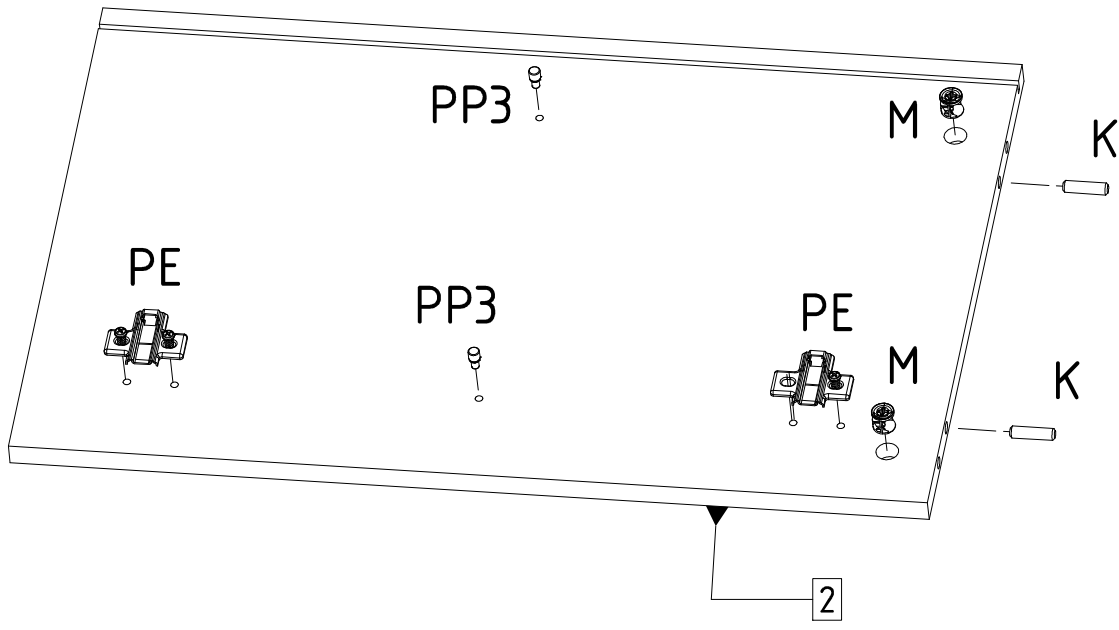
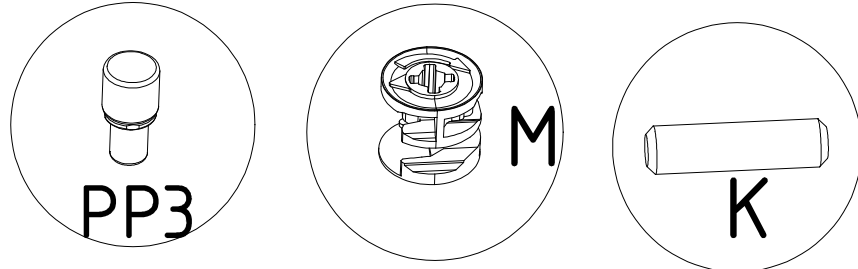
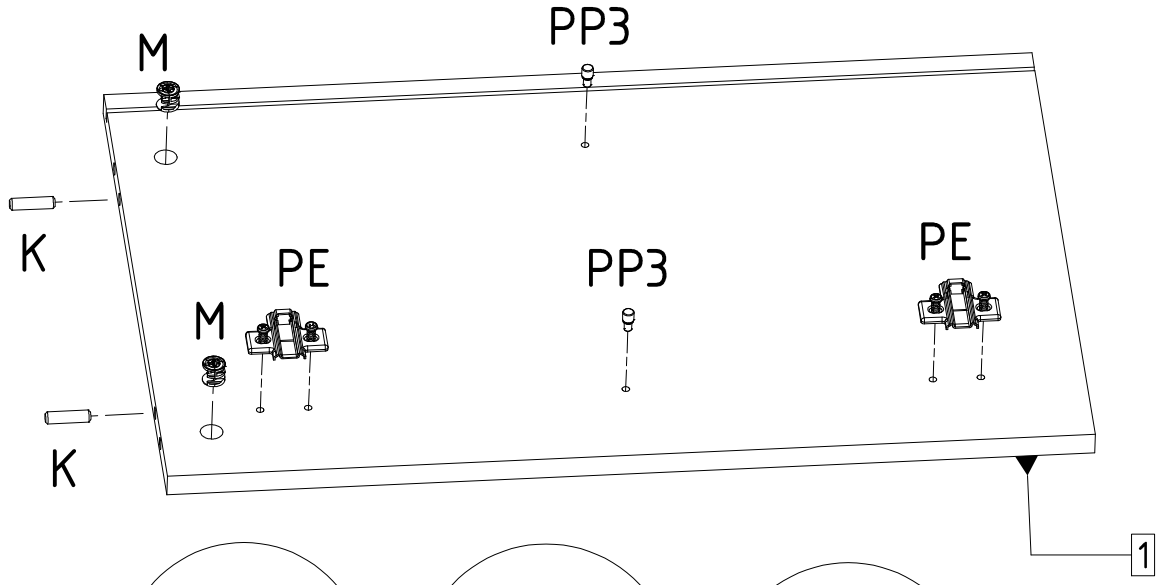
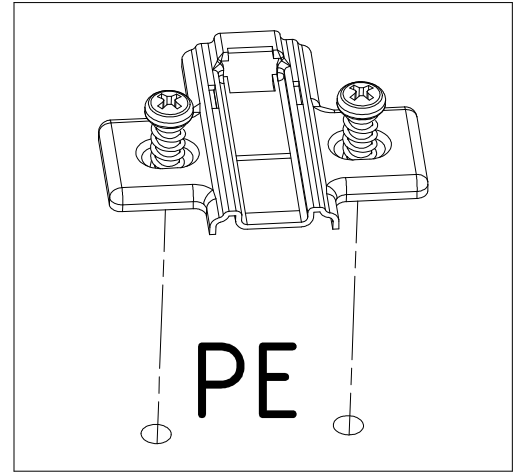
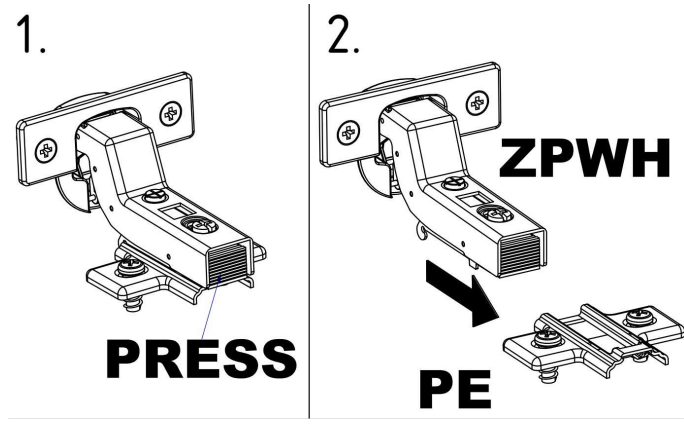

2.

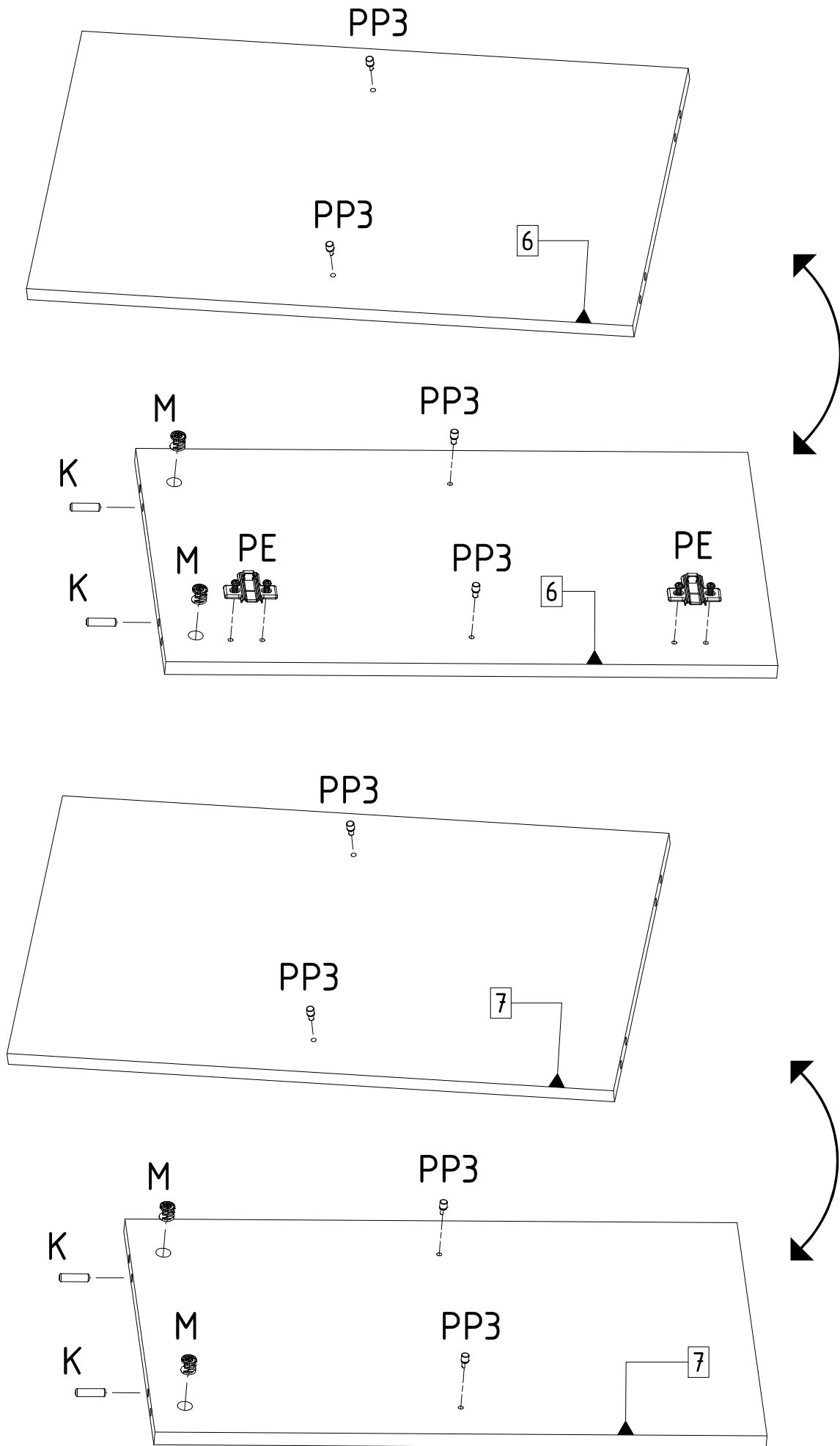

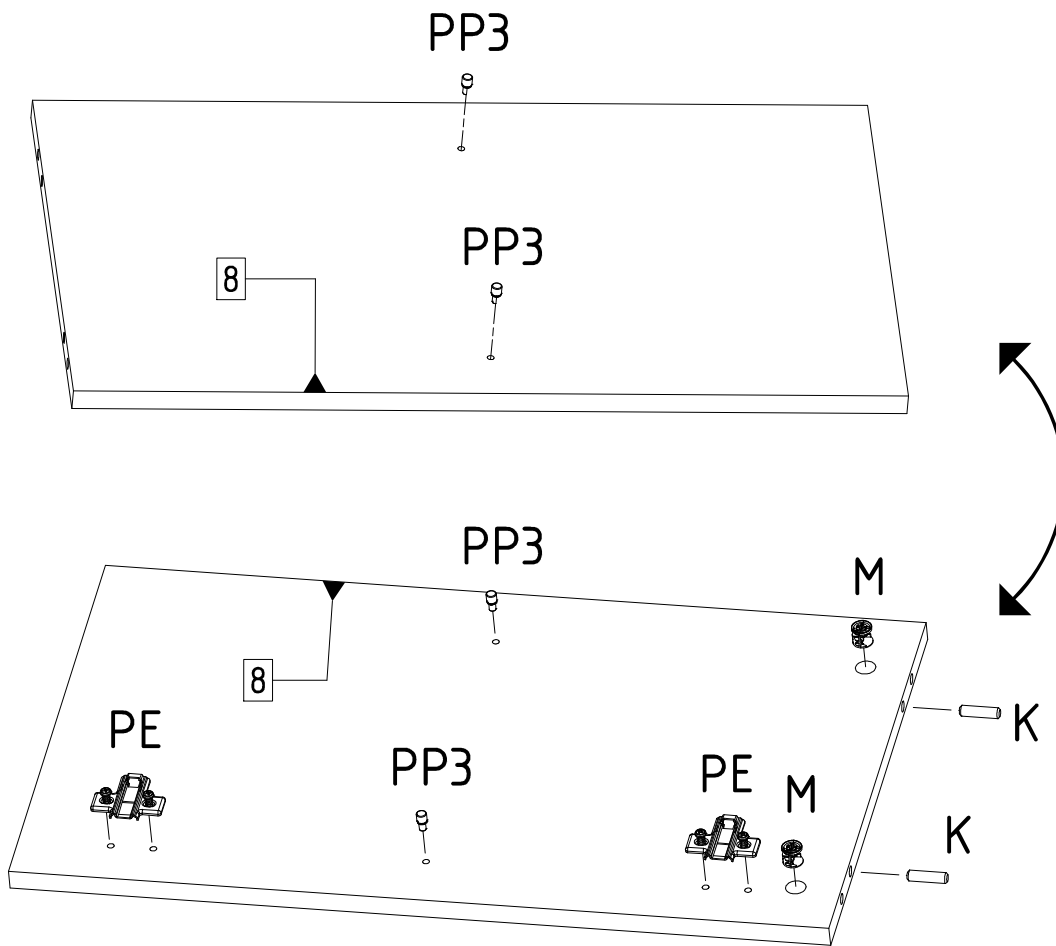

3.

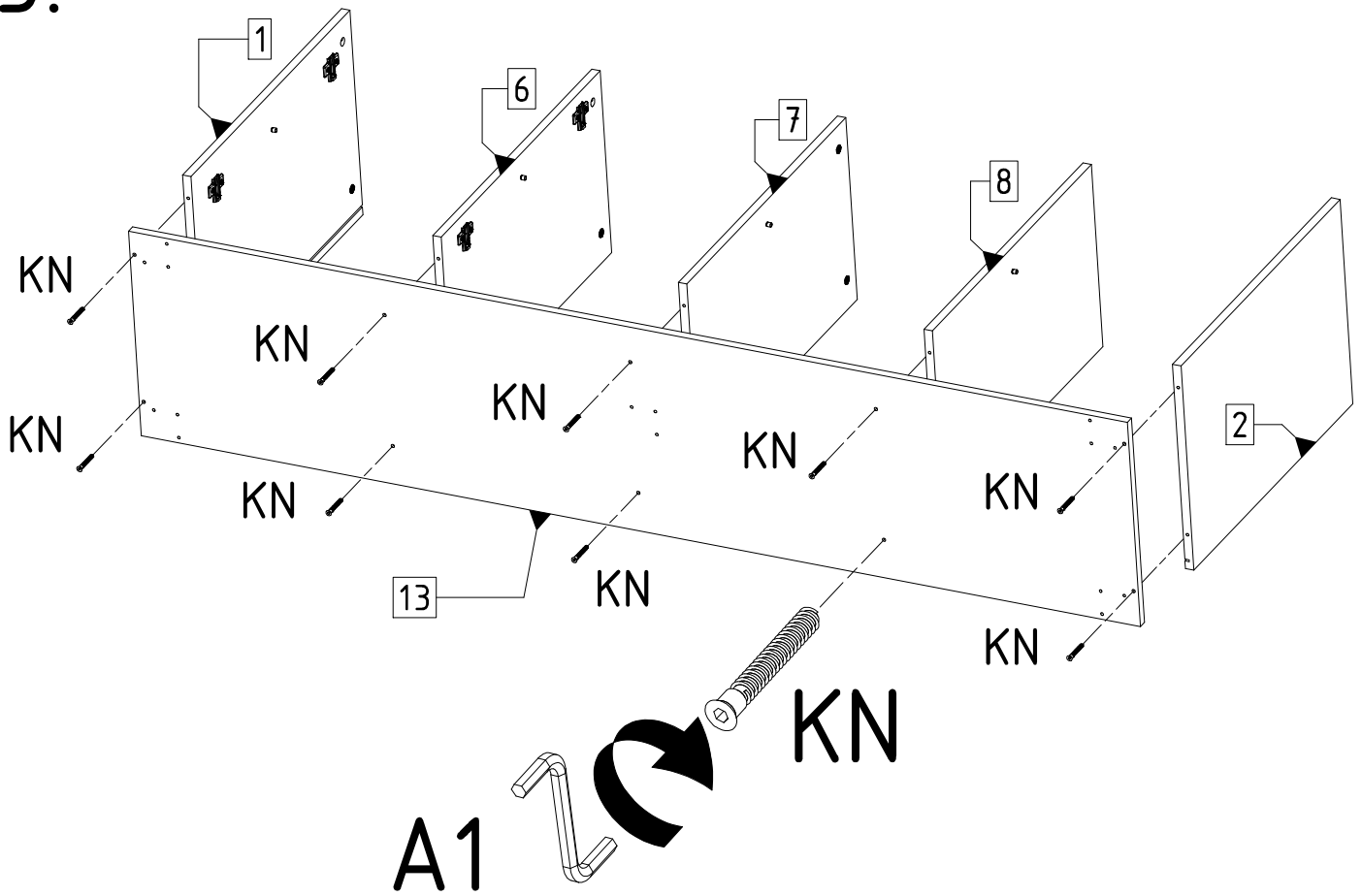

4.

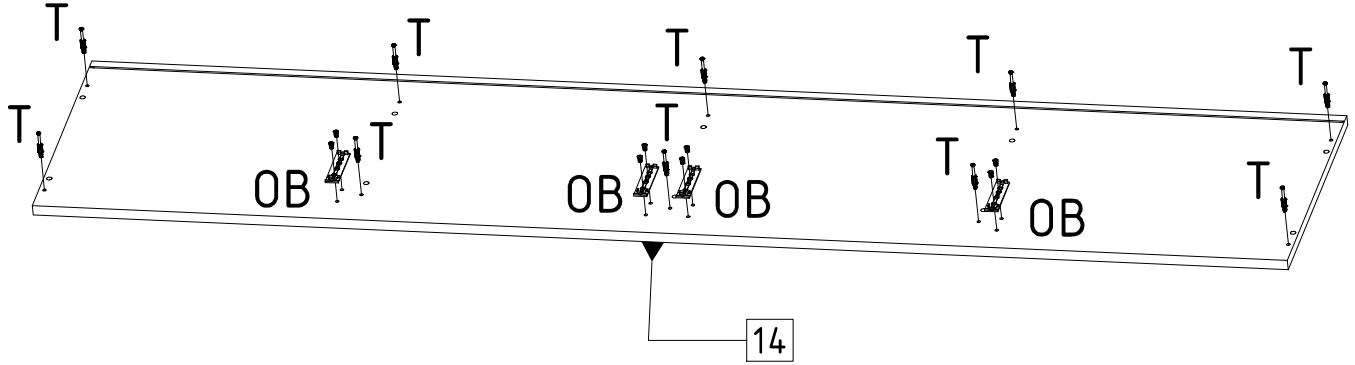
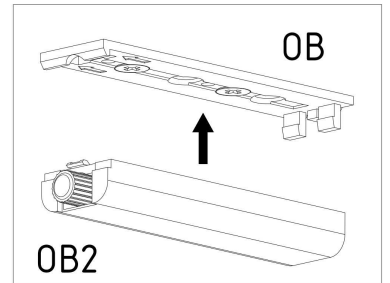
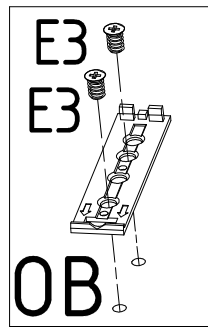
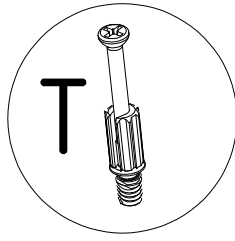

5.

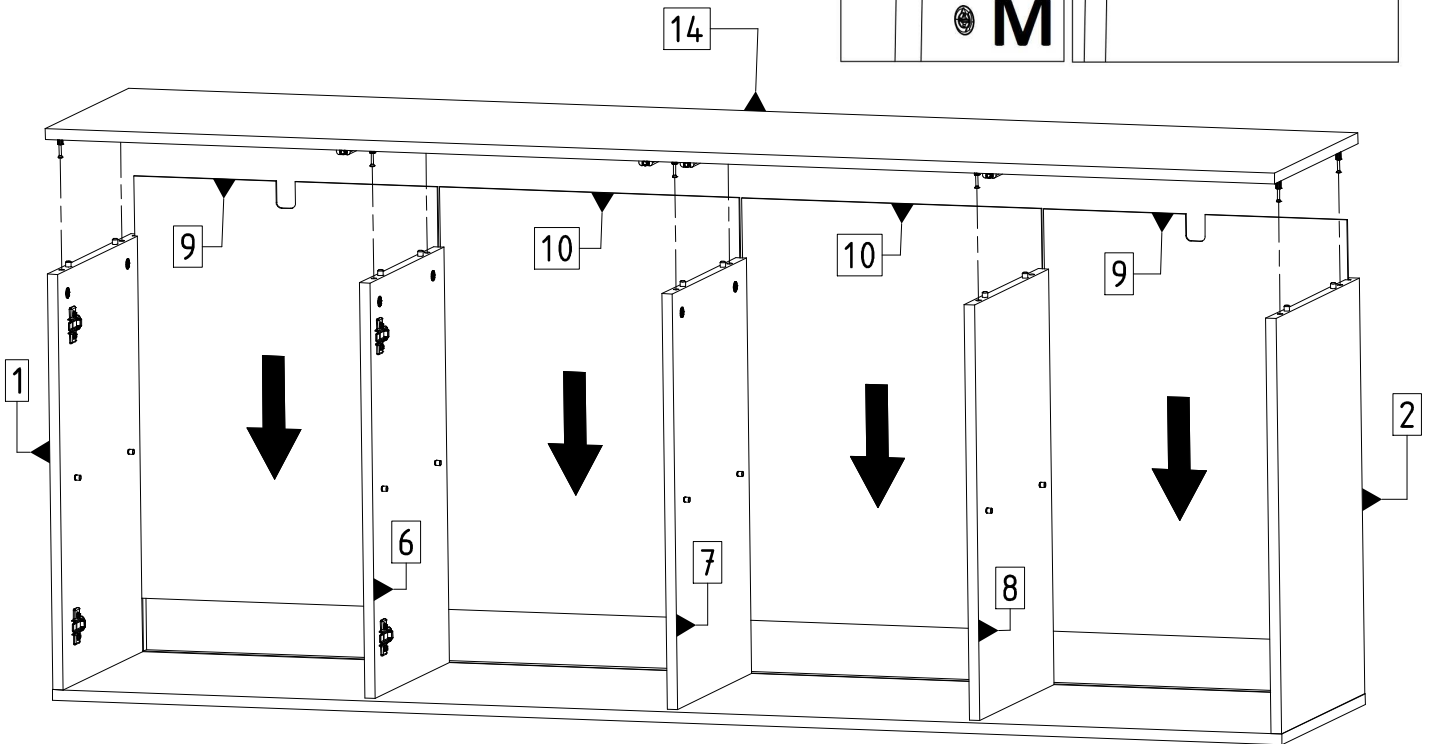
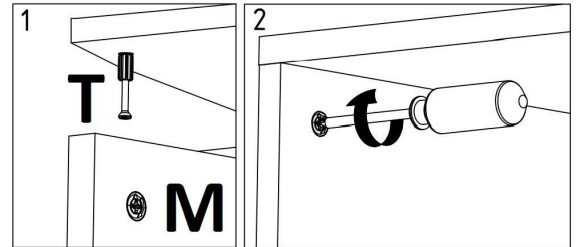

6.

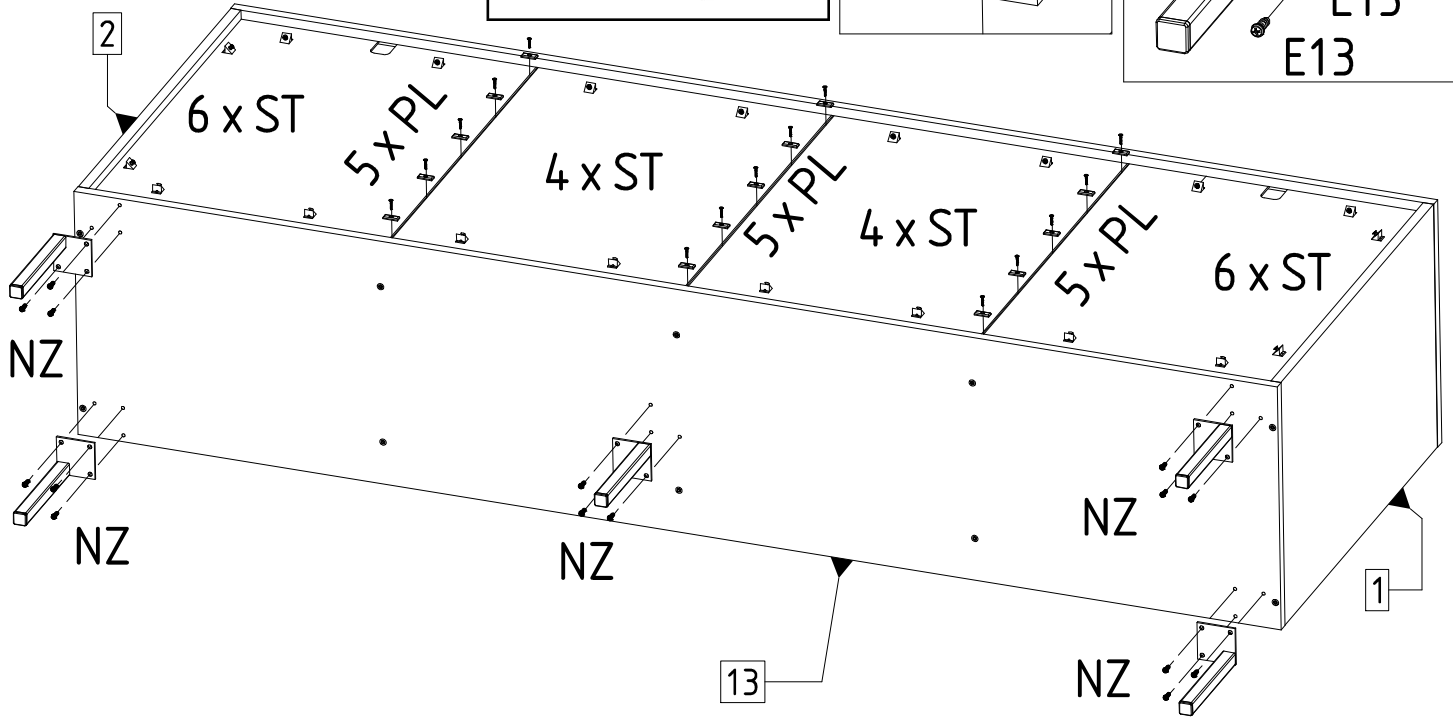
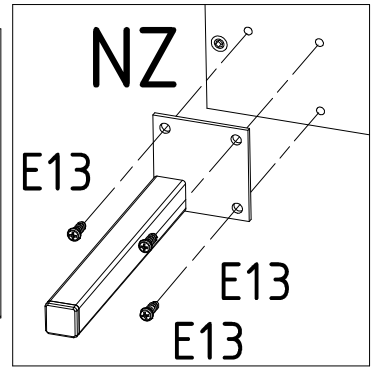
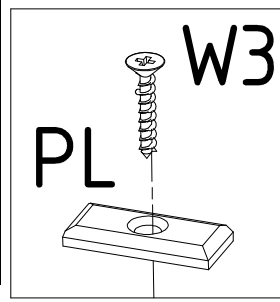
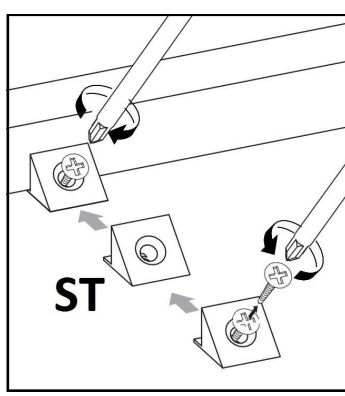
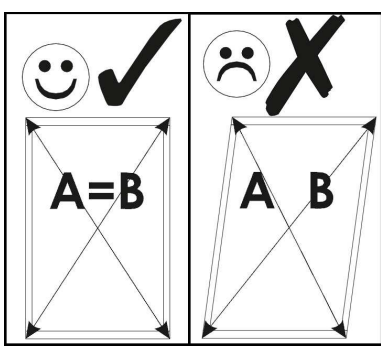

7.

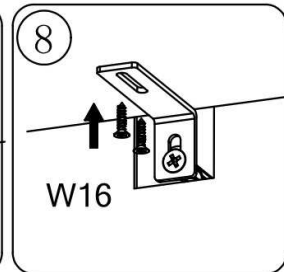
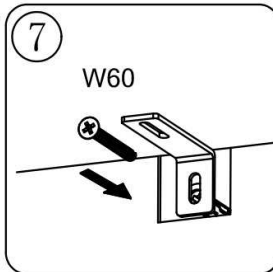
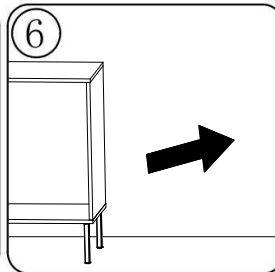
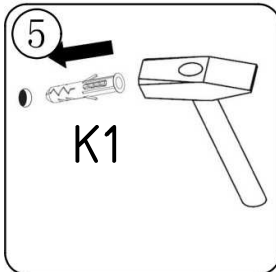
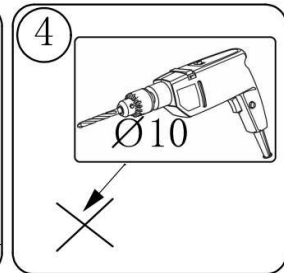
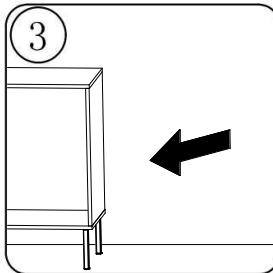
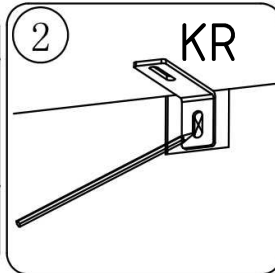
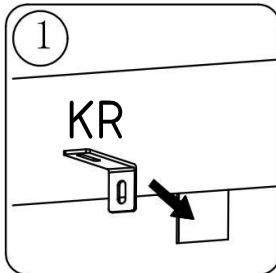
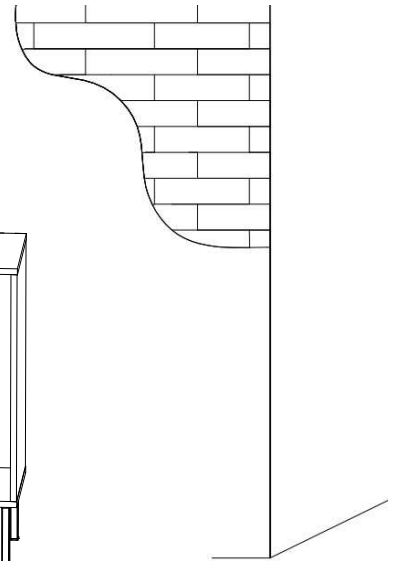
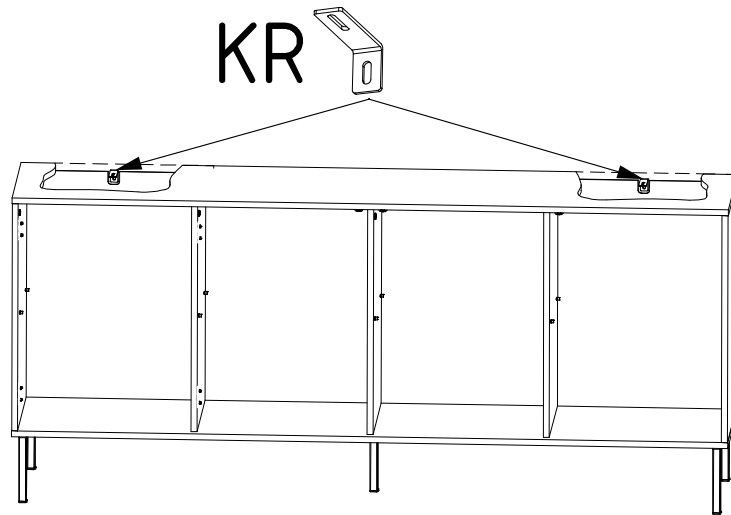

8.

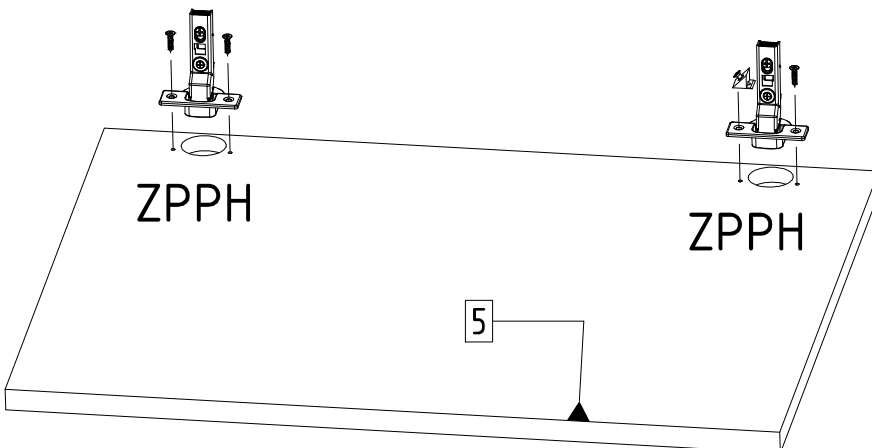
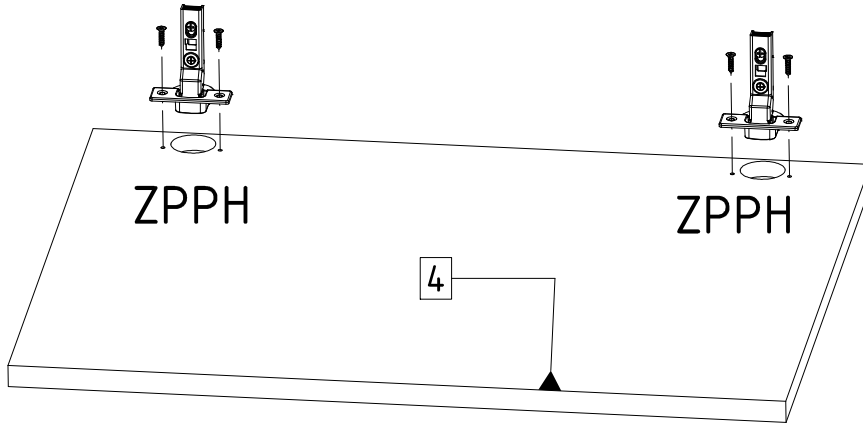
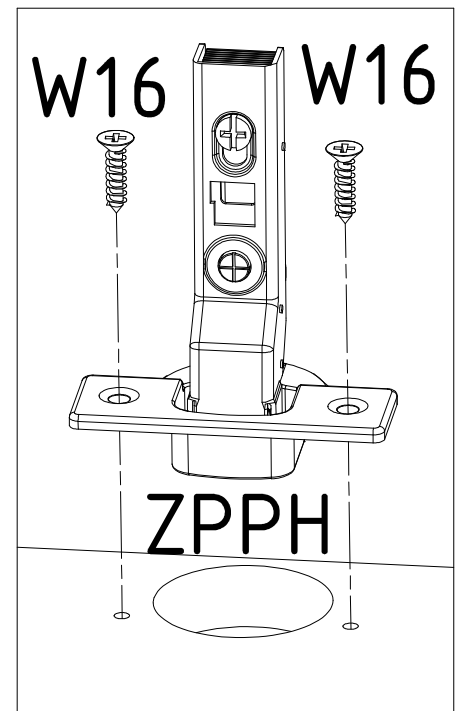
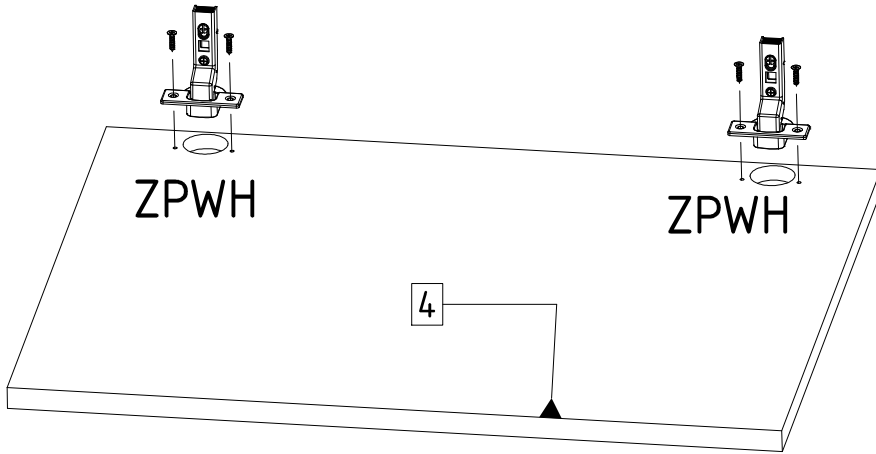
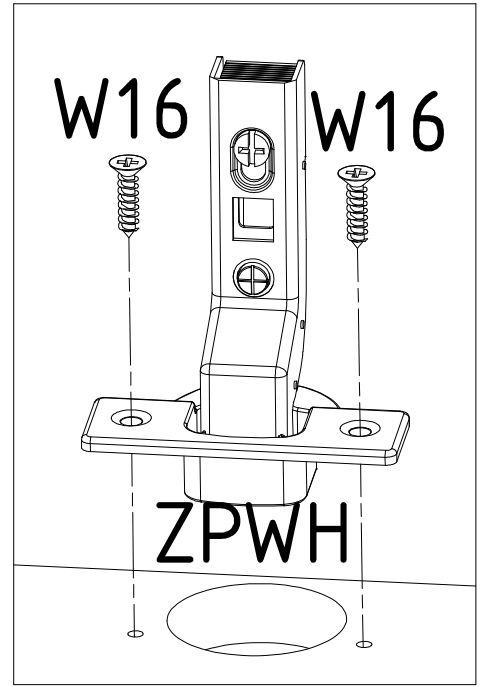
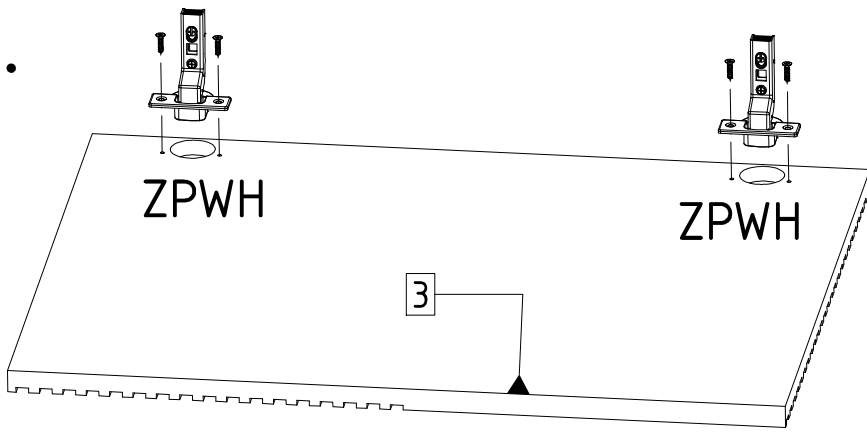

9.

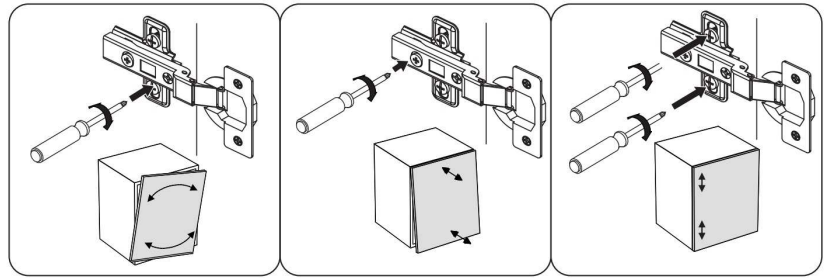
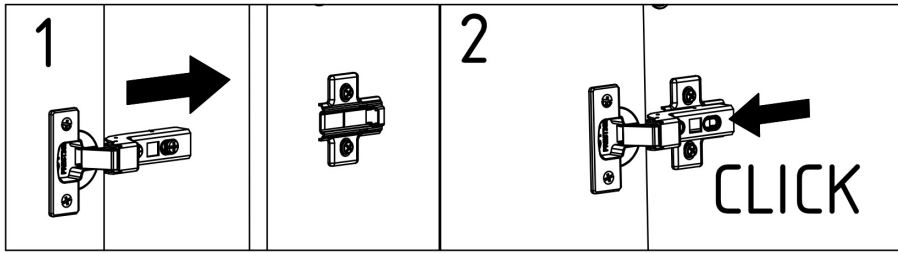
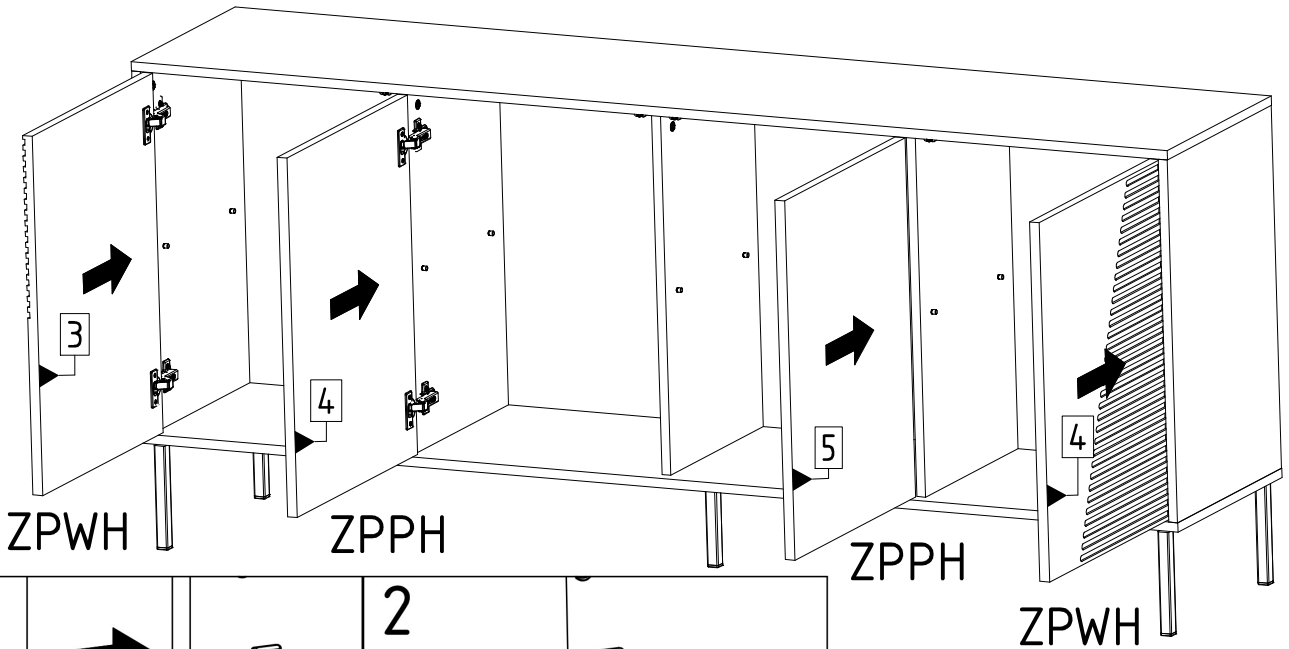

 max.
15 kg

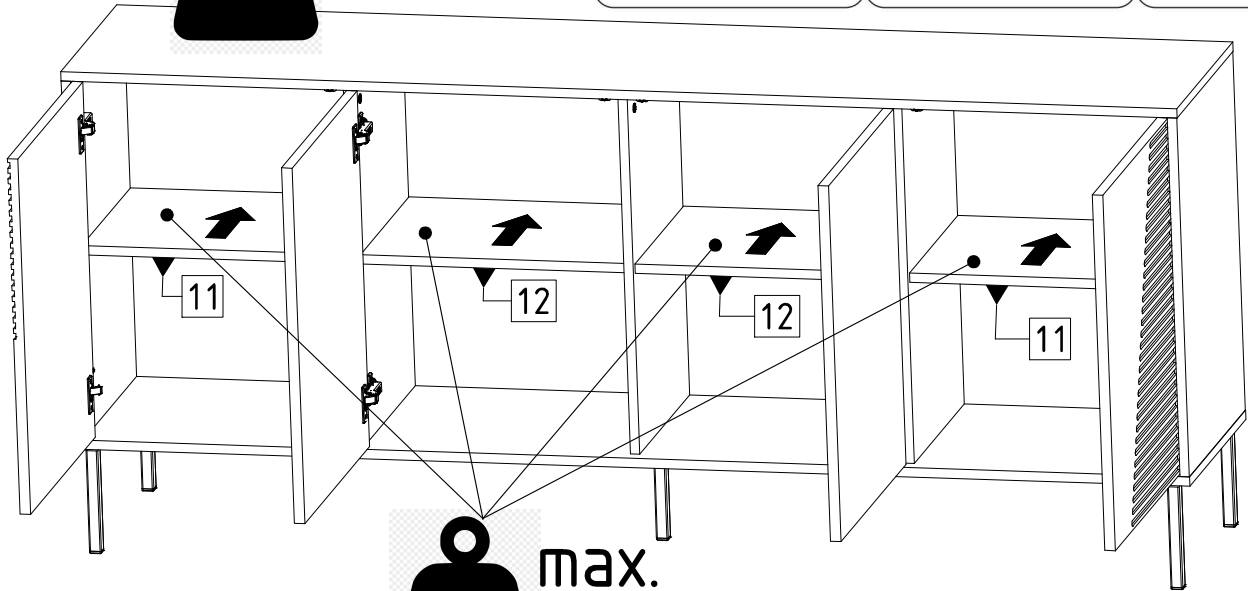

 max.
5 kg

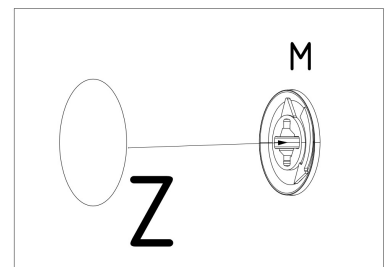
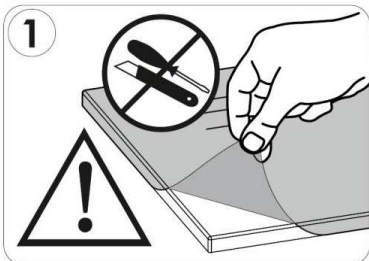

IMPORTANT SAFETY INFORMATION

WALL MOUNTING FURNITURE SAFETY INFORMATION AND WARNING

ATTENTION: This article provides basic information for mounting your wall mounted floating furniture to a wall using a wall mount bracket.

- **WARNING!** There's a risk of damage to your furniture and wall and injury to person if you don't follow the assembly or installation instructions correctly. We're not liable for any damages or injury caused by mishandling or improper installation of the wall-mount bracket.
- **WARNING!** If you use substitute items other than the supplied screws, the furniture may fall and cause physical injury to someone or damage to the furniture and/or wall.
- **WARNING!** Do not attempt to mount furniture that is not sold as wall mounting furniture.
- We strongly recommend that a qualified professional install your furniture on the wall for product protection and safety reasons. Sufficient expertise is required to determine the strength of the wall for withstanding the furniture's weight.
- Check the wall-mount installation manual supplied with your furniture for information on how to properly mount your furniture. Product manuals are posted on our website at <https://meblefurniturerugs.com/pages/assembly>.
- We don't guarantee the use of third-party wall mount brackets or screws.
- Use the screws supplied with the wall-mount bracket when you attach the wall-mount bracket to the furniture.
- Any repairs or modifications done to the included wall mount bracket or any part of the wall mounted furniture are not recommended, and may cause an increased risk of damage to your furniture and wall, and potentially injury to person. Any repairs or modifications will void all warranty and technical support for this unit.

SAVE THIS SAFETY INFORMATION AND WARNING FOR FUTURE REFERENCE

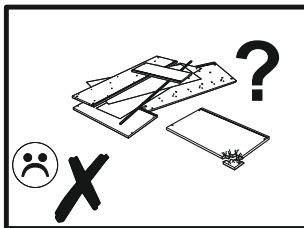
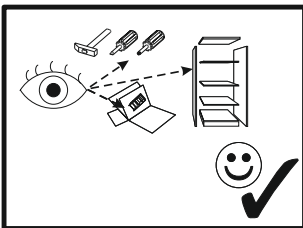

D: ALLGEMEINE HINWEISE FÜR MÖBEL AUS HOLZ UND HOLZWERKSTOFFE: MELAMIN, LAMINAT, ARMATURENBRETT
Zu reinigen, verwenden Sie ein feuchtes Tuch. Verwenden Sie nur Wasser oder ein mildes Reinigungsmittel. Wischen Sie mit einem Tuch trocken.

GB: GENERAL INSTRUCTIONS FOR FURNITURE OF WOOD AND WOOD MATERIALS: MELAMINE, LAMINATE, DASHBOARD
To clean, use a damp cloth. Use only water or a mild detergent. Wipe dry with a cloth.

ES: INSTRUCCIONES GENERALES PARA MUEBLES DE MADERA Y MATERIALES: MELAMINA, LAMINADO, TABLERO DE INSTRUMENTOS
Para limpiar, utilice un paño húmedo. Utilice sólo agua o un detergente suave. Seque con un paño

FR: INSTRUCTIONS GENERALES DE MEUBLES DE MATÉRIAUX DE BOIS ET: MÉLAMINÉS, STRATIFIÉS, TABLEAU DE BORD
Pour nettoyer, utilisez un chiffon humide. d'eau ou d'un détergent doux. Essuyer avec un chiffon.

CZ: VŠEOBECNÉ POKYNY PRO NÁBYTEK ZE DŘEVA A DŘEVĚNÝCH MATERIÁLŮ: MELAMINE, LAMINÁT, DASHBOARD
K čištění použijte vlhký hadřík. Používejte pouze vodu nebo jemným čistícím prostředkem. Vytřete do sucha hadříkem.

PL: OGÓLNE INSTRUKCJE DOTYCZĄCE MEBLI Z DREWNA ORAZ MATERIAŁÓW DREWNOPOCHODNYCH: MELAMINA, LAMINAT, OKLEINA
Do czyszczenia należy używać wilgotnej ściereczki. używać wyłącznie wody lub delikatnego detergentu. Wycierać do sucha ściereczką.

HU: A BÚTOR ÁLTALÁNOS FAANYAGOK ÉS FAIPARI ANYAGOK: MELAMIN, LAMINÁT, MÚSZERFAL
A tisztításhoz használjon egy nedves ruhával. Csak vizet vagy enyhe tisztítószerrel. Töröld szárazra egy ronggyal.

HU: A BÚTOR ÁLTALÁNOS FAANYAGOK ÉS FAIPARI ANYAGOK: MELAMIN, LAMINÁT, MÚSZERFAL
A tisztításhoz használjon egy nedves ruhával. Csak vizet vagy enyhe tisztítószerrel. Töröld szárazra egy ronggyal.

SK: VŠEOBECNÉ POKYNY PRO NÁBYTEK ZE DŘEVA A DŘEVĚNÝCH MATERIÁLŮ: MELAMINE, LAMINÁT, DASHBOARD
Na čistenie použite vlhkú handričku. používajte iba vodu alebo jemným čistiacim prostriedkom. Vytrite dosucha handričkou.

RU: ОБЩИЕ ПРАВИЛА ДЛЯ МЕБЕЛИ ДРЕВЕСИНЫ И ДРЕВЕСНЫХ МАТЕРИАЛОВ: МЕЛАМИН, ЛАМИНАТ, ПАНЕЛЬ
Для очистки используйте влажную ткань. Используйте только воду или мягкое моющее средство. Протрите сухой тряпкой.

IT: ISTRUZIONI GENERALI PER MOBILI DI LEGNO E LEGNO MATERIALI: MELAMINICO, LAMINATO, CRUSCOTTO
Per la pulizia, utilizzare un panno umido. Utilizzare solo acqua o un detergente neutro. Asciugare con un panno.

RO: INSTRUCȚIUNI GENERALE DE MOBILIER DE LEMNOASA ?I MATERIALE LEMNOASE: PAL, LAMINAT, TABLOU DE BORD
Pentru a curăța, folosiți o carpa umeda. Folosiți numai apa sau un detergent slab. Stergeți cu o carpa.

TR: AHŞAP VE AHŞAP MALZEMELERIN MOBİLYA İÇİN GENEL BİLGİLER: MELAMIN, LAMINAT, PANEL
Temizlemek için, nemli bir bez kullanın. Sadece su veya hafif bir deterjan kullanın. Bir bez ile kurulayın.

NL: ALGEMENE RICHTLIJNEN VOOR MEUBELEN VAN HOUT EN HOUTPRODUCTEN MATERIALEN: MELAMINE, LAMINAAT, DASHBOARD
Schoon te maken, gebruikt u een vochtige doek. Gebruik alleen water of een mild schoonmaakmiddel. Veeg met een doek droog.

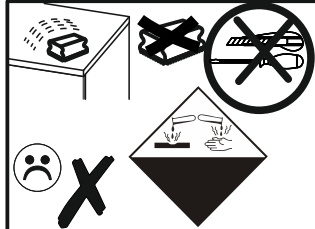
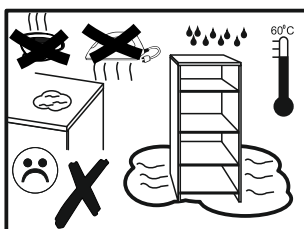
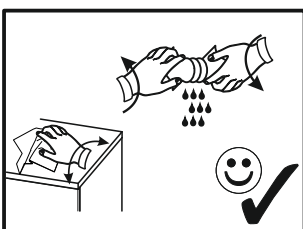
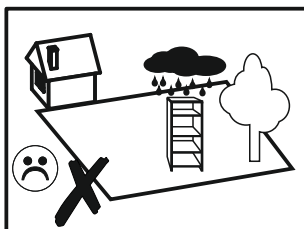
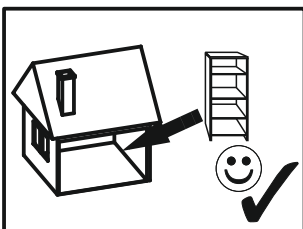
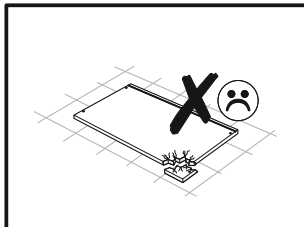
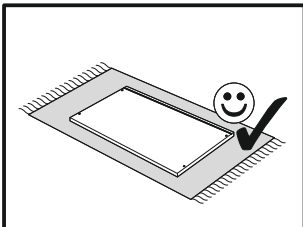
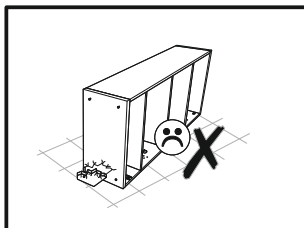
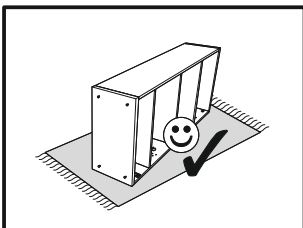
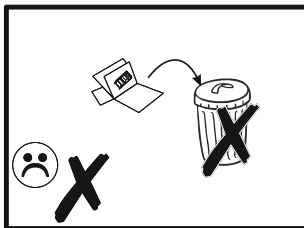
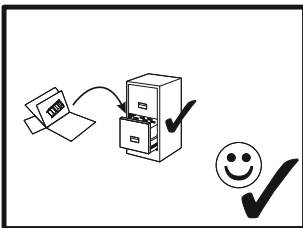

PL: Komplementowanie akcesorii oraz proces pakowania odbywa się pod nadzorem kontroli jakości oraz monitoringu.

EN: Complementing the accessories and the packaging process is carried out under the supervision of quality control and monitoring.

DE: Die Ergänzung des Zubehörs und des Verpackungsprozesses erfolgt unter der Aufsicht der Qualitätskontrolle und -überwachung.

FR: Le complément des accessoires et du processus d'emballage s'effectue sous la supervision d'un contrôle et d'une surveillance de la qualité.

