

GRAND

GRAND_07_IM

OP-18, 28

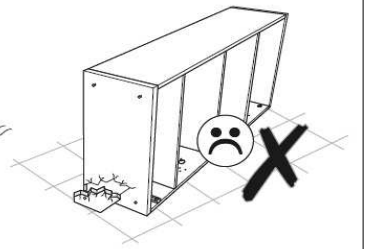
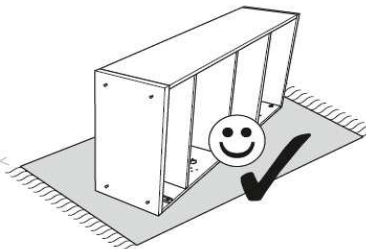
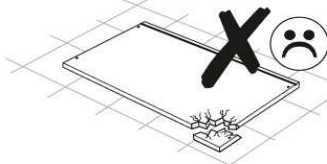
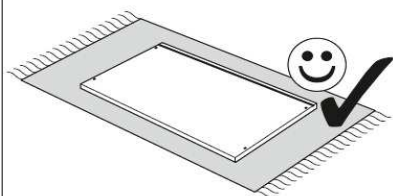
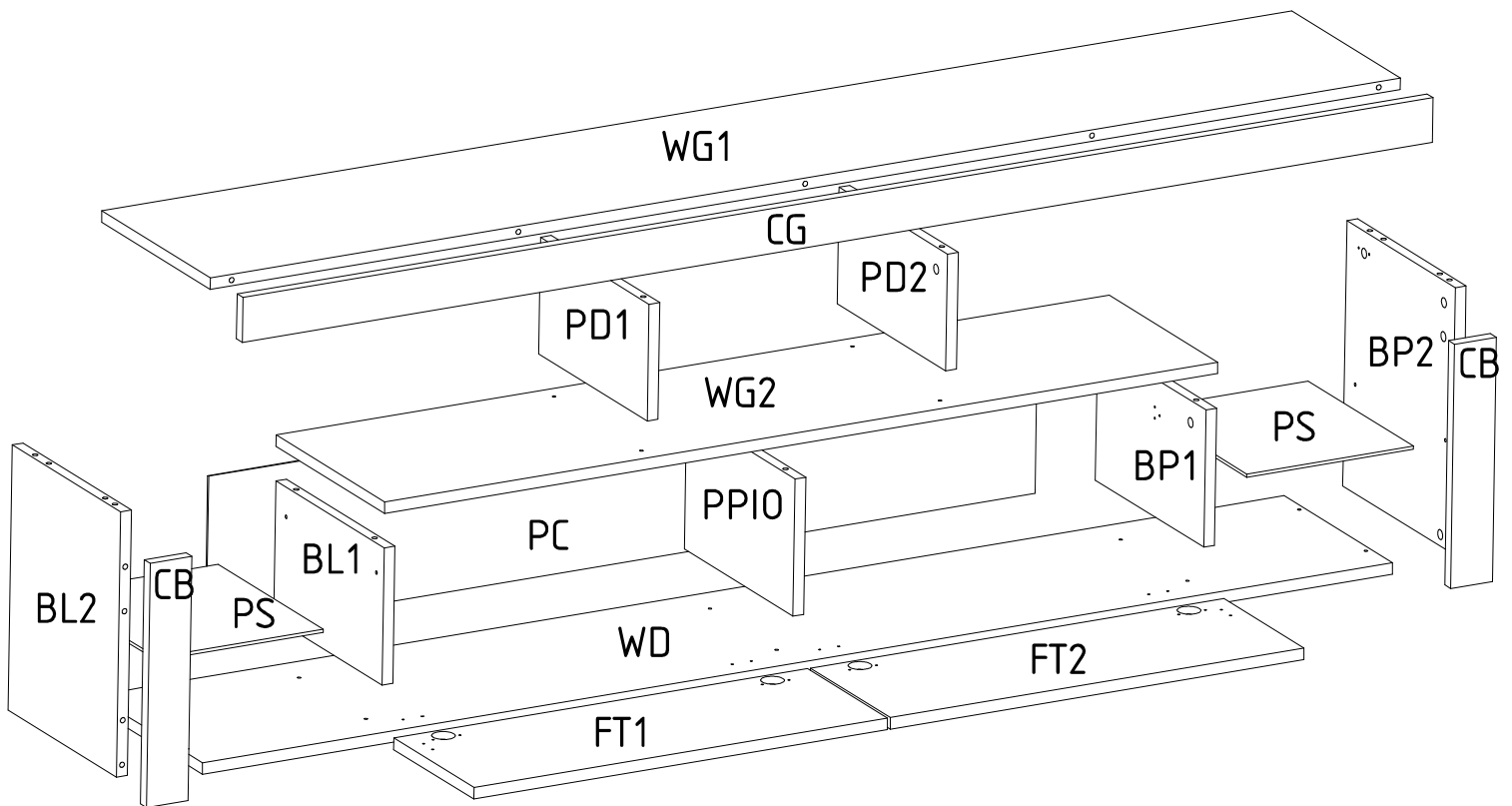
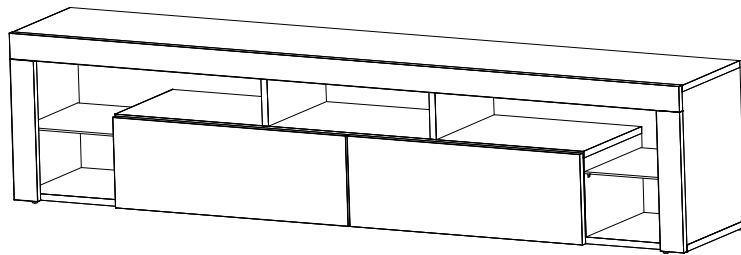
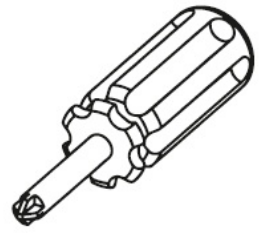
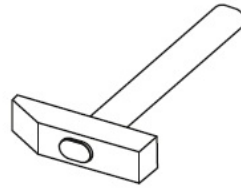
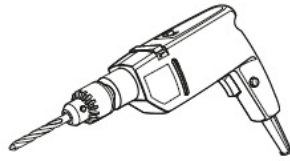
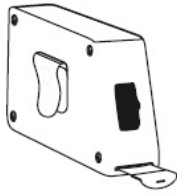
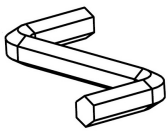
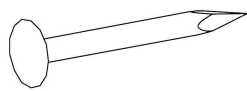
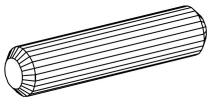
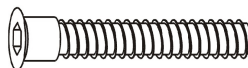

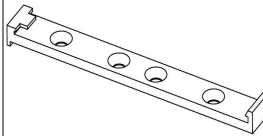
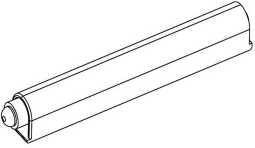
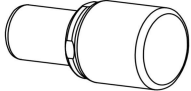
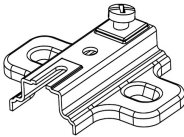
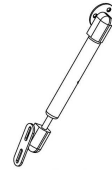
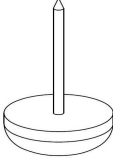
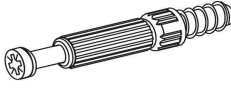
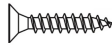
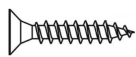
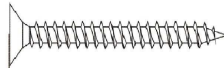
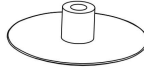
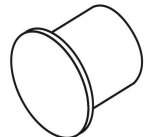

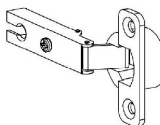
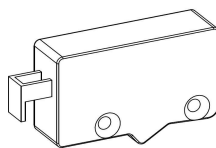
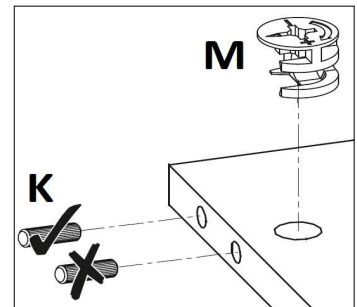
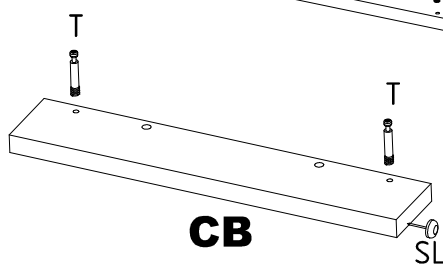
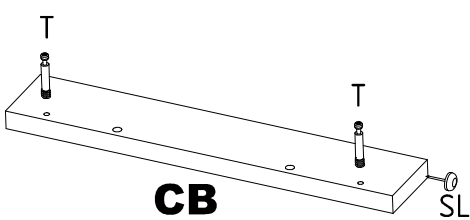
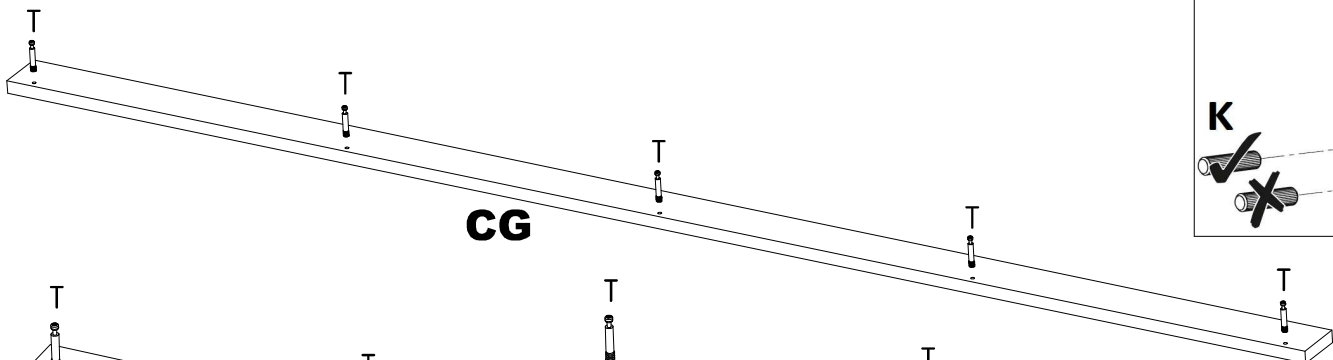
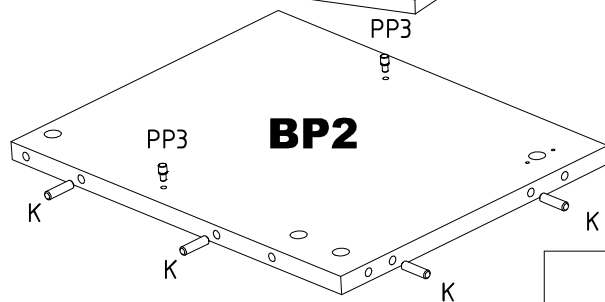
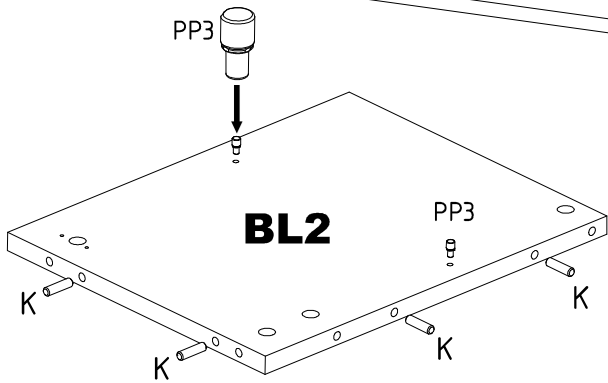
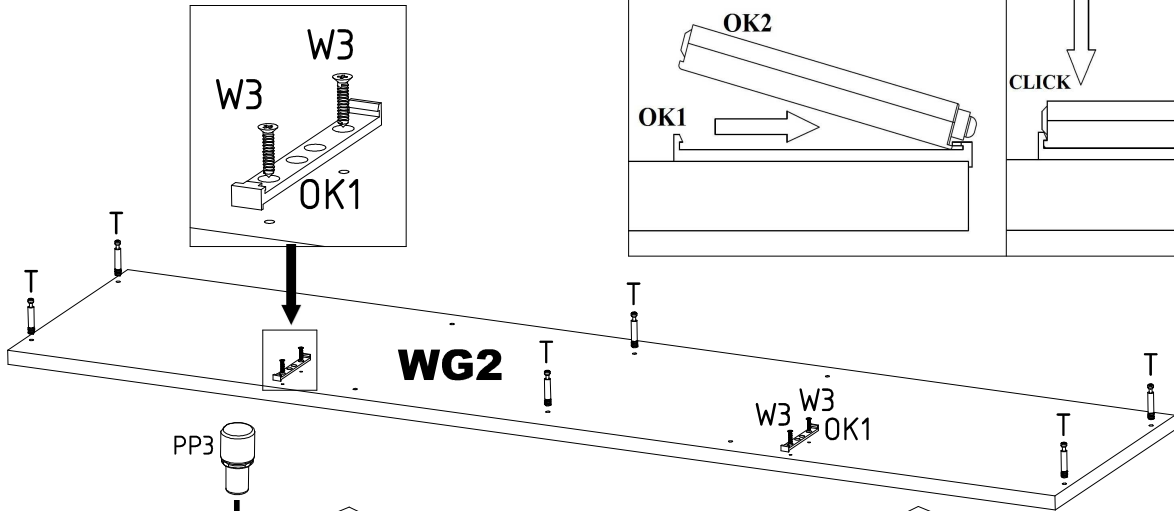
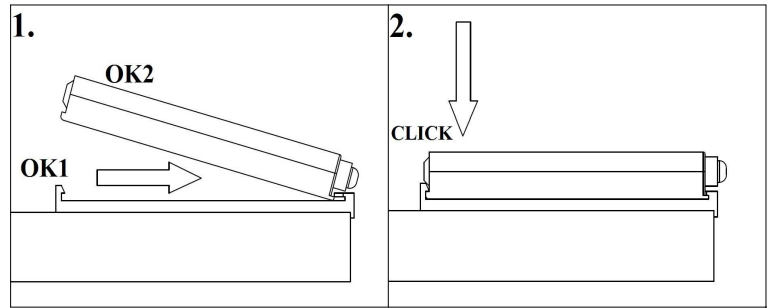
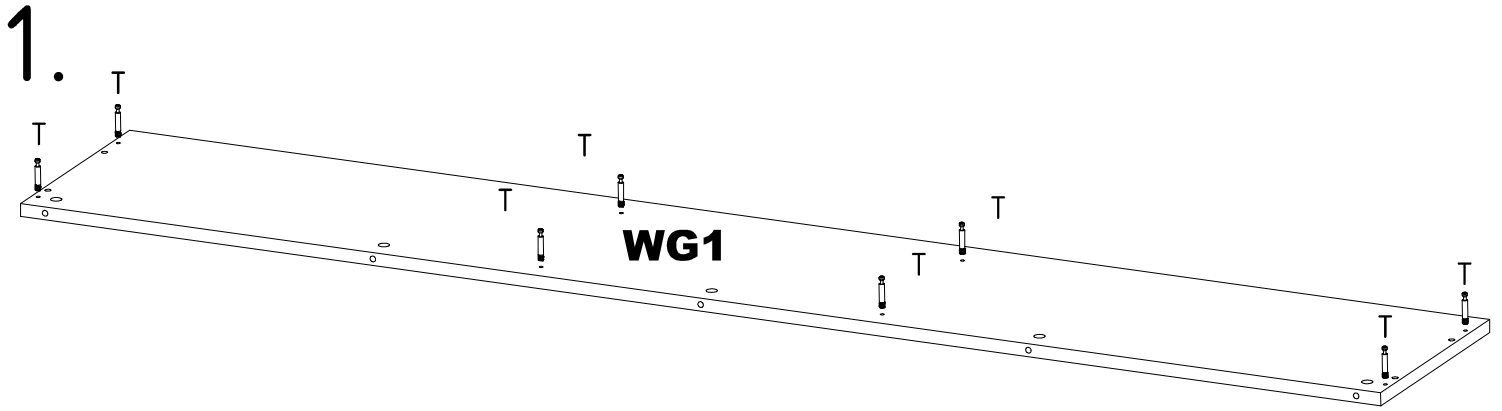
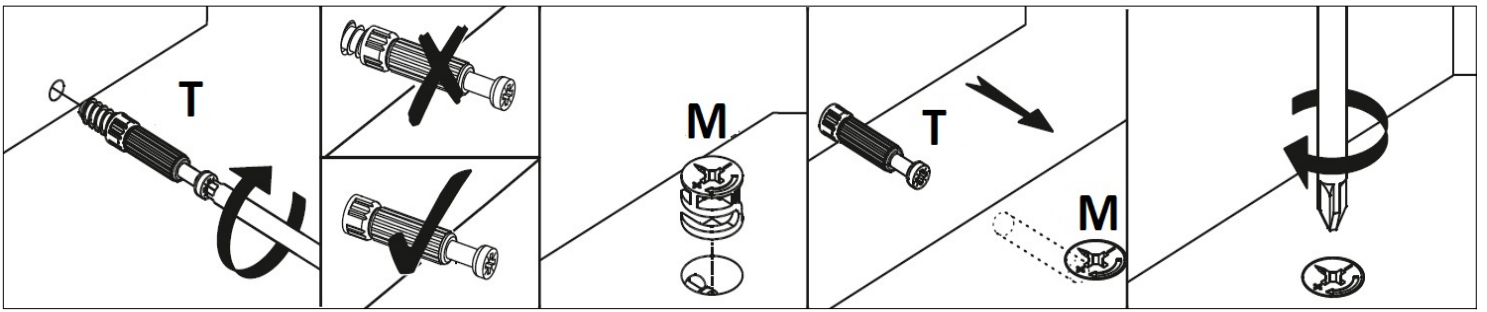
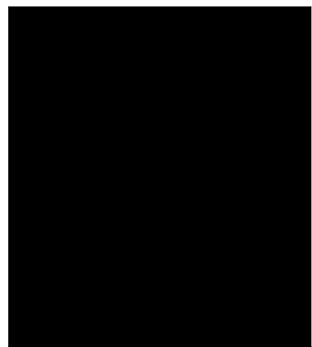
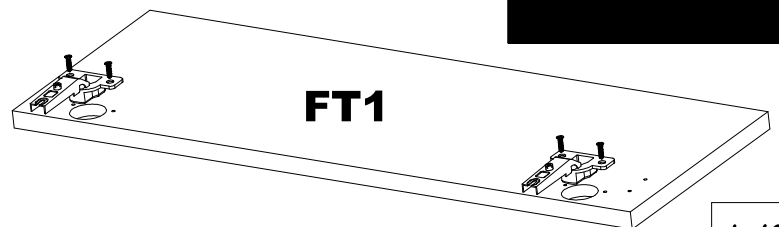
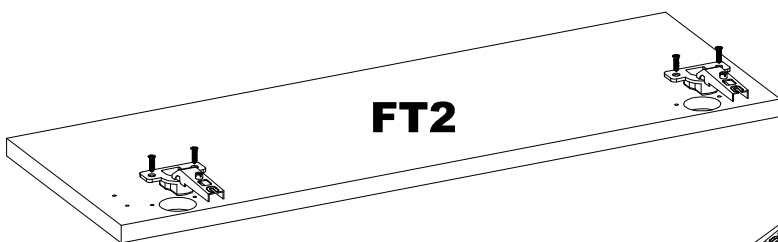
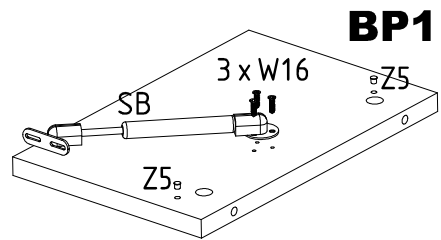
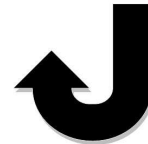
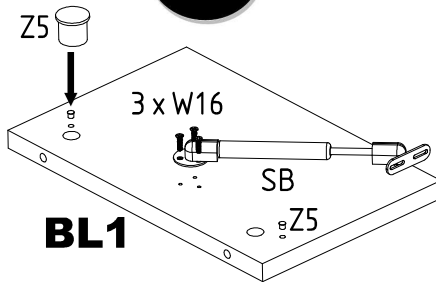
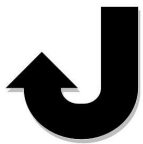
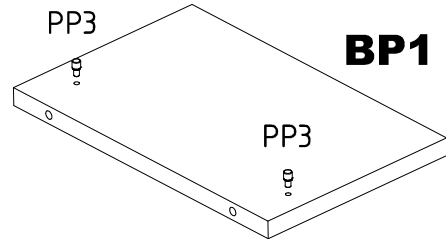
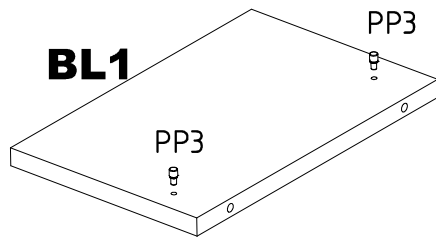
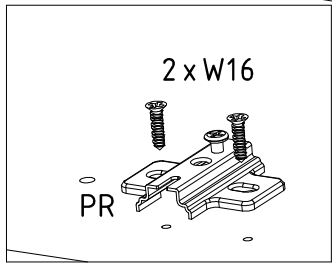
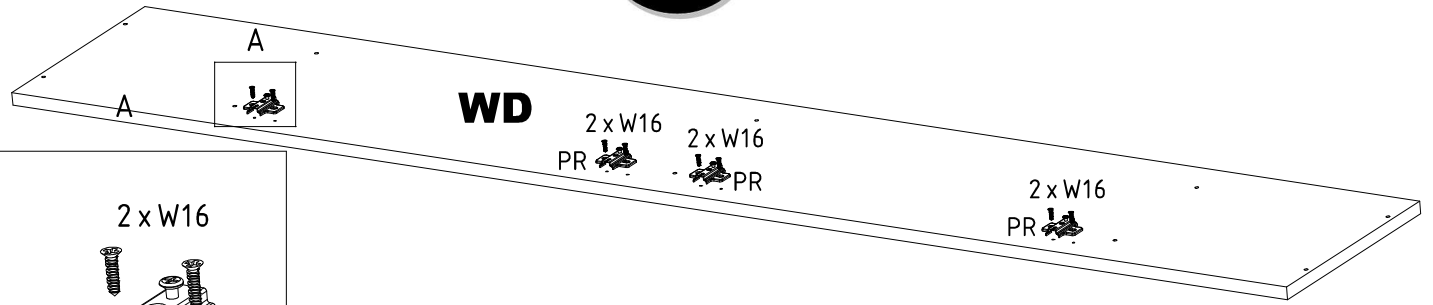
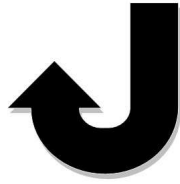
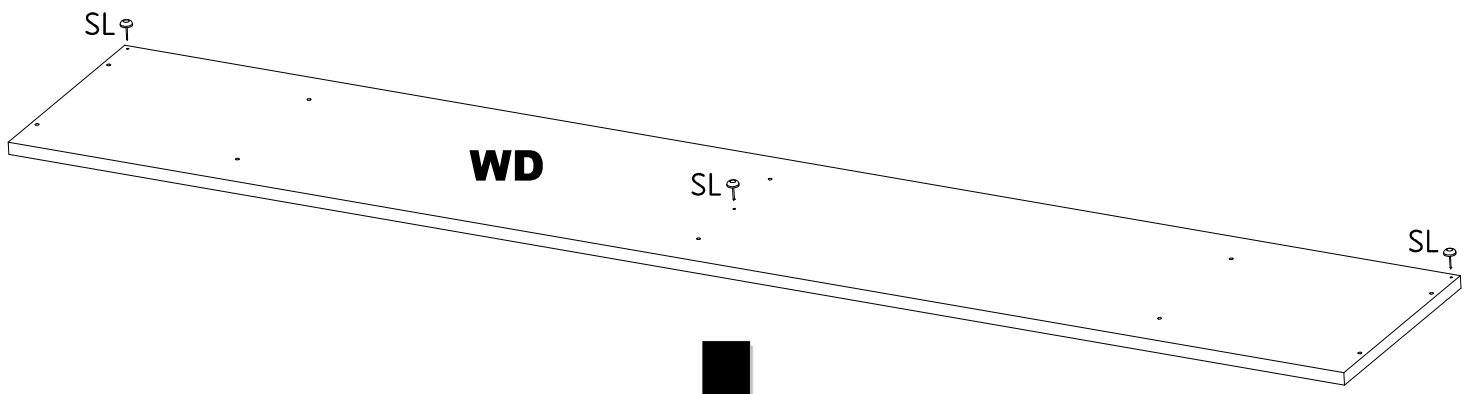

Table accessories

 A1	 G	8 x 30  K	6,3 X 50  KN	15 x 12  M
 OK1	 OK2	 PP3	 PR	 SB
 SL	6 x 34 mm  T	4 x 16  W16	3 x 16mm  W3	4 X 35  W30
 Z	 Z5	 ZK	 ZP	 ZR

Elements				Accessories	
SYMBOL	LENGTH	WIDTH	QUANTITY	SYMBOL	QUANTITY
BL1	13.07	8.43	1	A1	1
BL2	16.3	13.07	1	G	36
BP1	13.07	8.43	1	K	8
BP2	16.3	13.07	1	KN	14
CB	15	2.76	2	M	23
CG	78.74	2.76	1	OK1	2
FT	27.36	9.65	2	OK2	2
PC	9.61	54.84	1	PP3	8
PD1	13.07	7.17	1	PR	4
PD2	13.07	7.17	1	SB	2
PPI0	13.07	8.43	1	SL	5
PS	11.02	12.68	2	T	23
WD	78.74	13.07	1	W16	26
WG1	78.74	13.07	1	W3	4
WG2	55.12	13.07	1	W30	8
				Z	23
				Z5	4
				ZK	14
				ZP	4
				ZR	4





2.

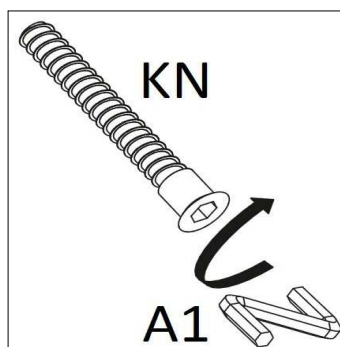
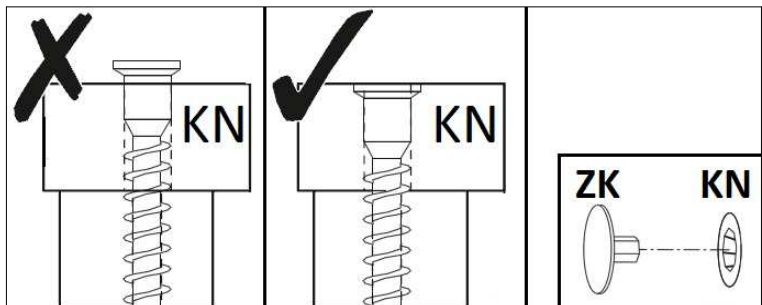
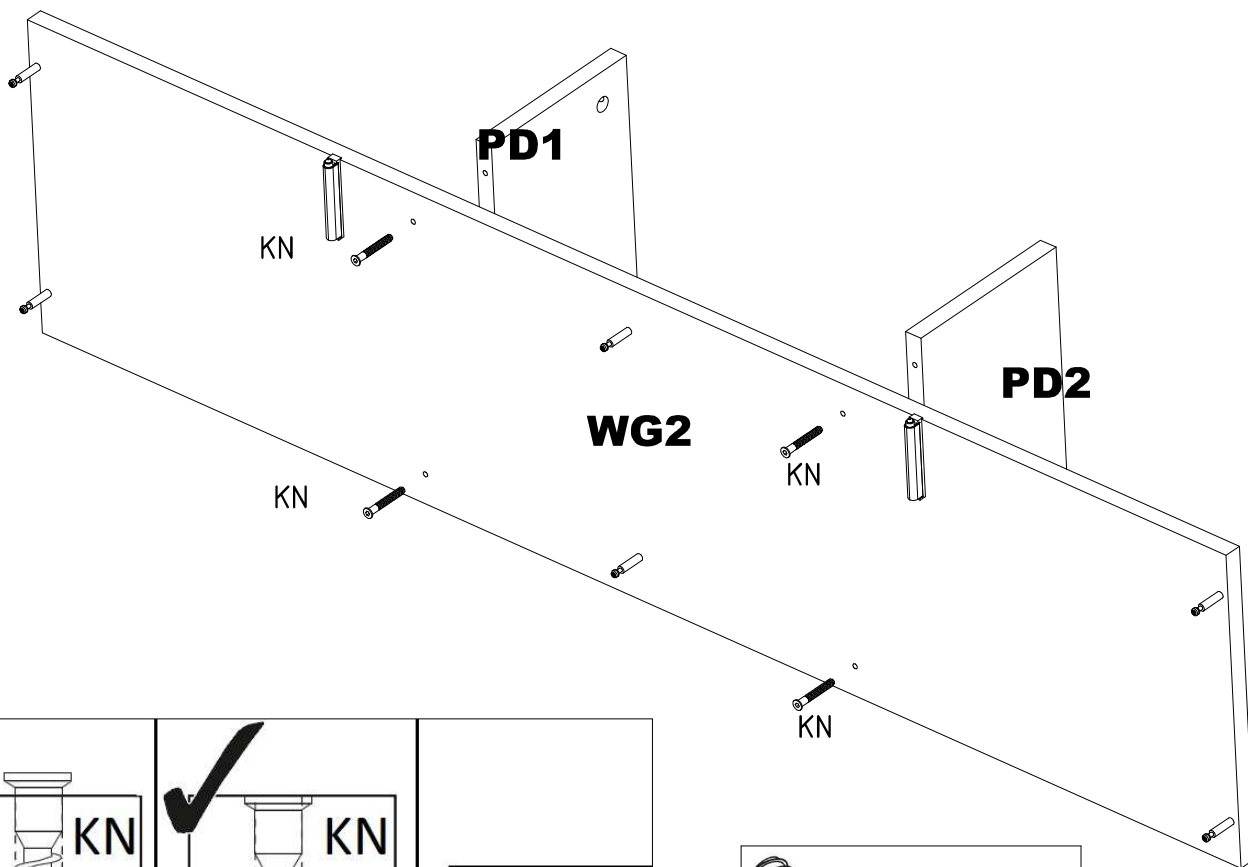

3.

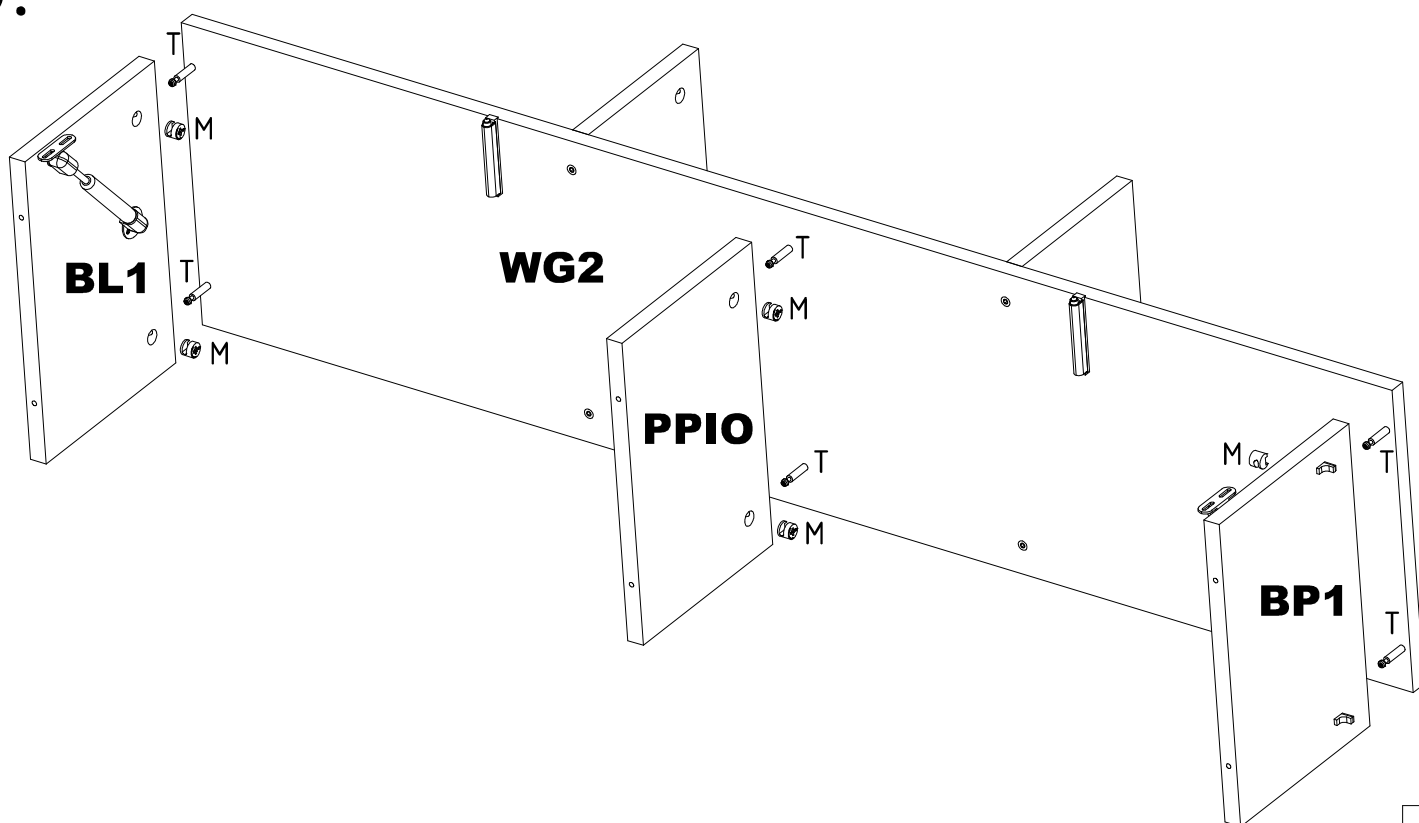

7.

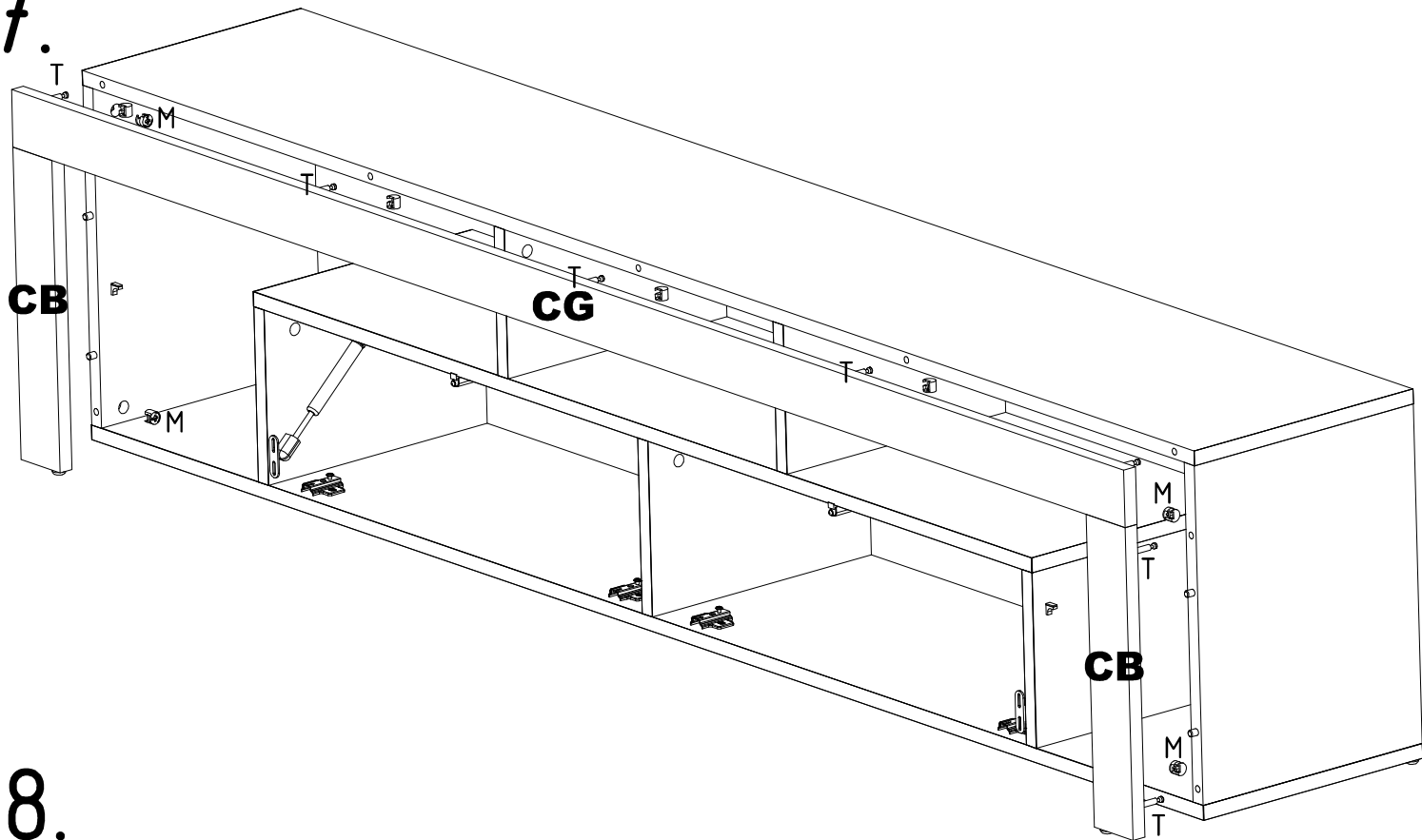

8.

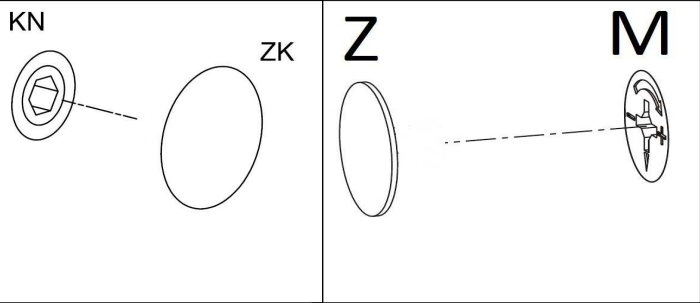
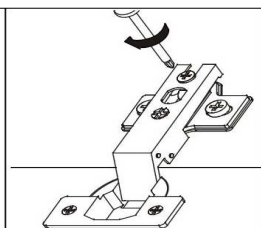
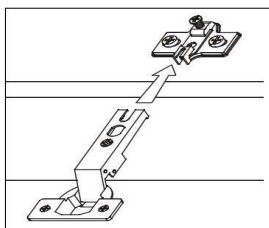
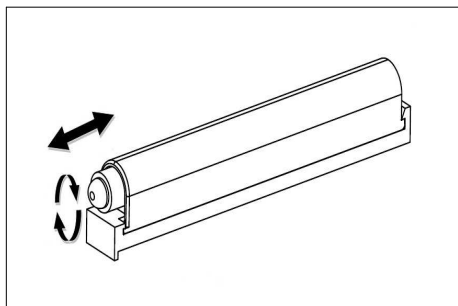
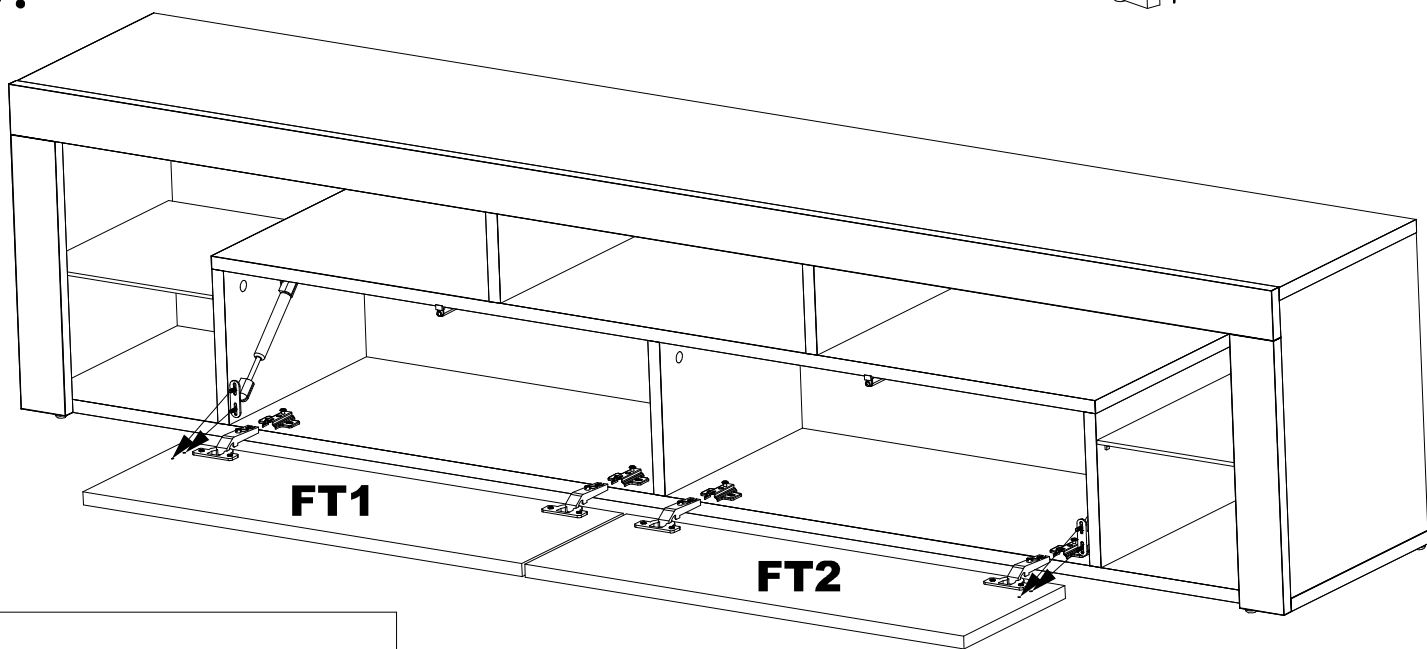

9.

