

# MANHATTAN RTV

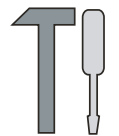

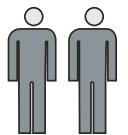

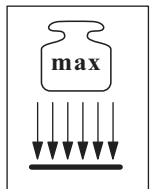

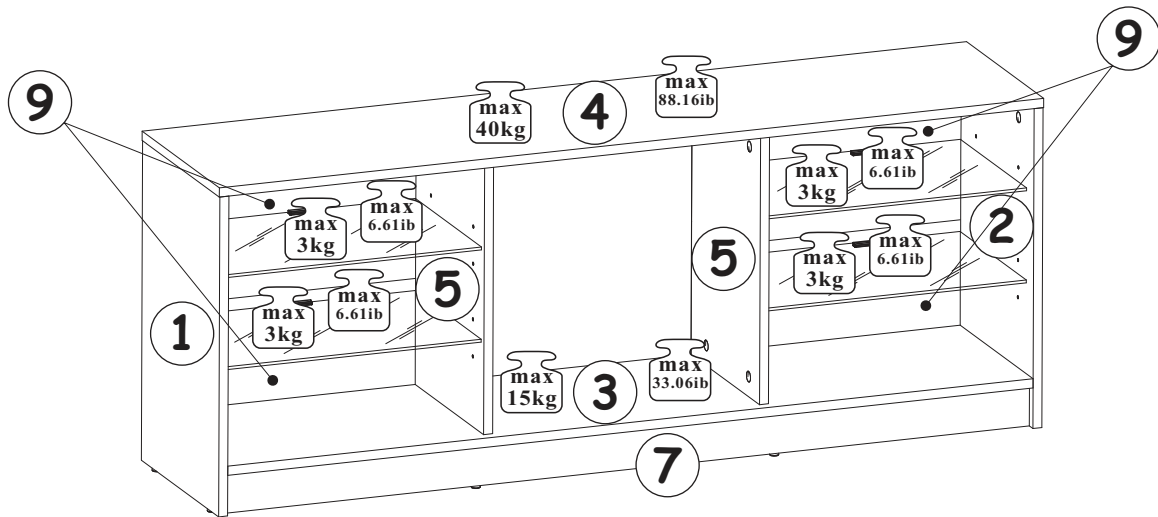
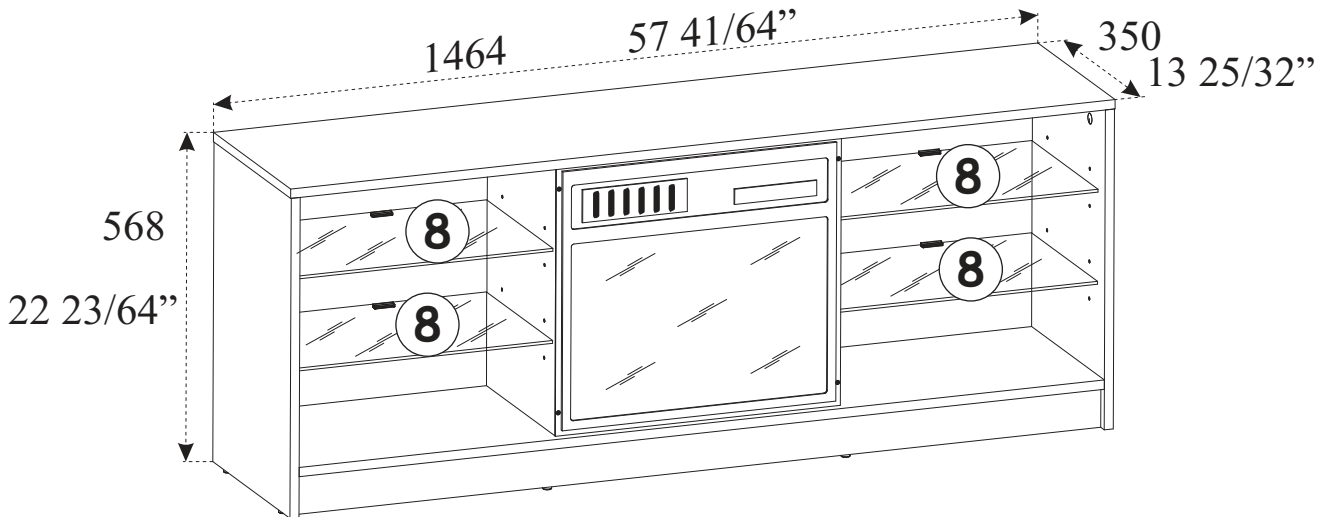



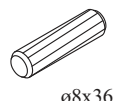
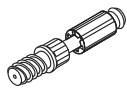

60 min

NO	Dim			Col.-No	Qty
1	552	350	16	1	1
5	466	310	16	1	2
2	552	350	16	1	1
4	1464	350	16	1	1
8	460	300	5	1	4
3	1430	330	16	1	1
7	1430	70	16	1	1
9	243	483	3	1	4

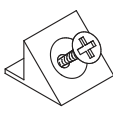
NO	Inch			Col.-No	Qty
1	21 47/64	13 25/32	5/8	1	1
5	18 11/32	12 13/64	5/8	1	2
2	21 47/64	13 25/32	5/8	1	1
4	57 41/64	13 25/32	5/8	1	1
8	18 7/64	11 13/16	13/64	1	4
3	56 19/64	12 63/64	5/8	1	1
7	56 19/64	2 3/4	5/8	1	1
9	9 11/16	19 1/64	1/8	1	4

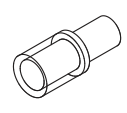
# MANHATTAN RTV

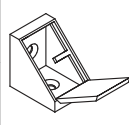
A1 x20	Ø5/16"x1 27/64"  ø8x36	B4 x16		B5 x16	Ø19/32"x15/32"  Ø15x12
UP13 x12	USØ1/8"x5/8"  UPØ3x16	D10 x4	USØ9/64"x33/64"  USØ3,5x13	I2 x6	
PE1 x1		G2 x1		S1 x8	
LZ3 x1		G20 x16		G5 x16	
LED x4		KM1 x2			

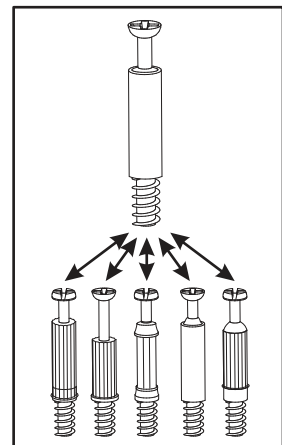
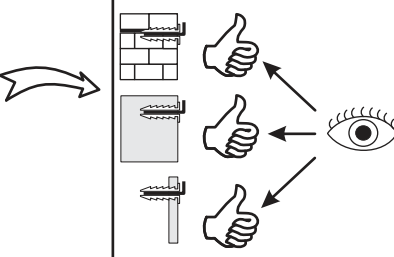
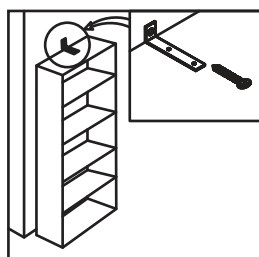
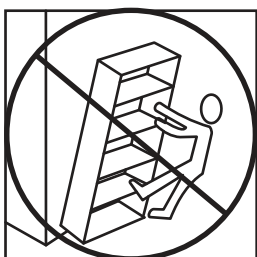
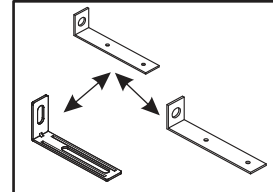
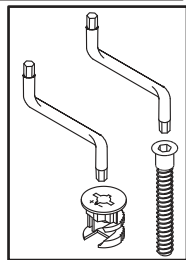
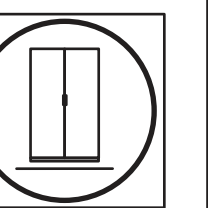
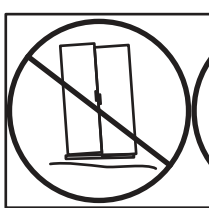
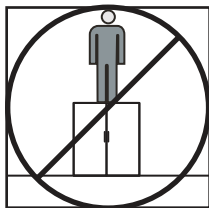
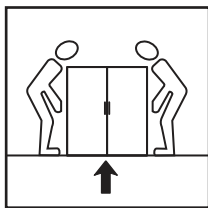
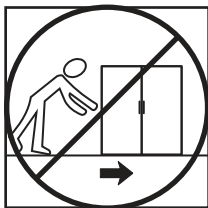
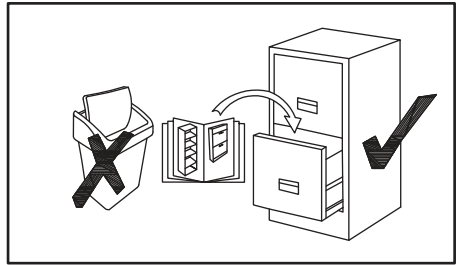
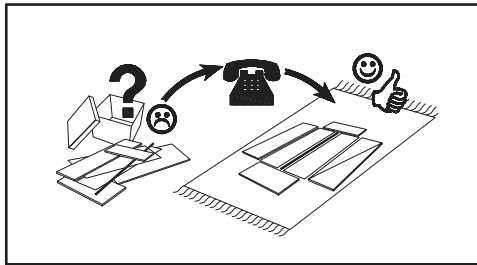
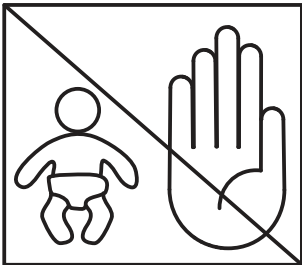
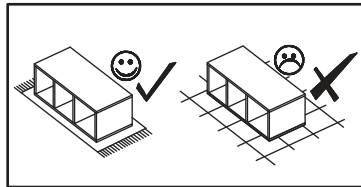
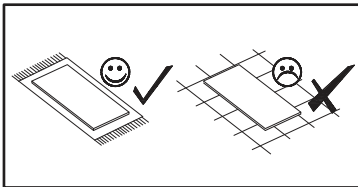
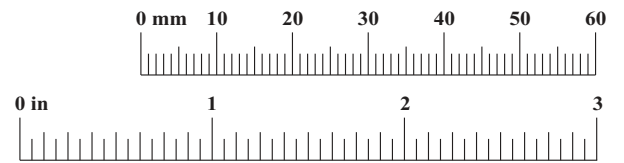

# MANHATTAN RTV

1

A1	Ø5/16"x1 27/64"
x2	 ø8x36

B5	Ø19/32"x15/32"
x2	 Ø15x12

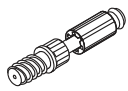
B4	
x2	

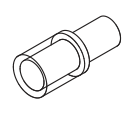
G20	
x4	

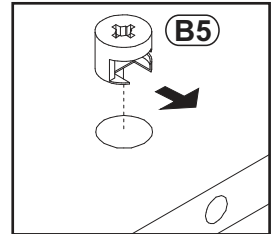
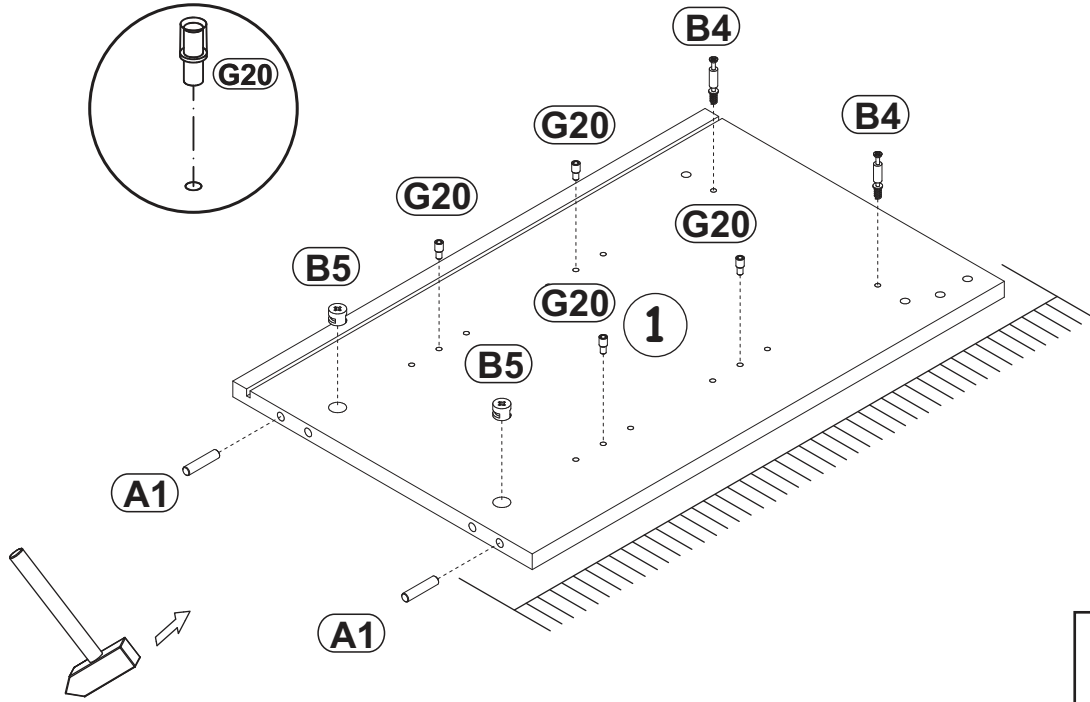

2

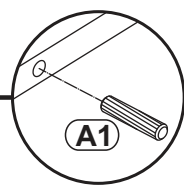
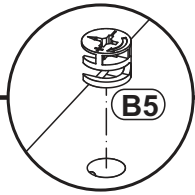
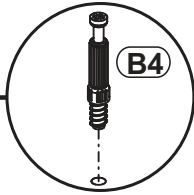

A1	Ø5/16"x1 27/64"
x2	 ø8x36

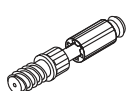

B5	Ø19/32"x15/32"
x2	 Ø15x12

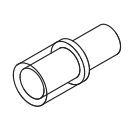
B4	
x2	

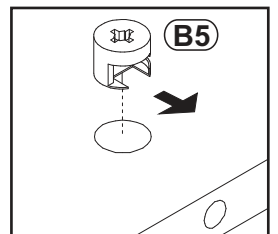
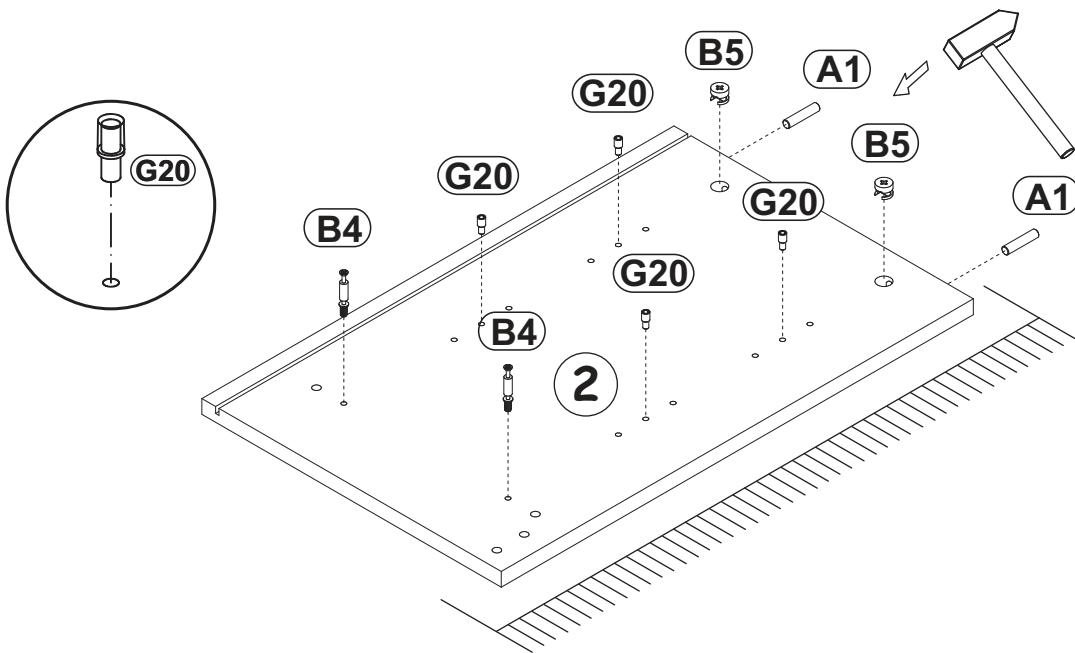
G20	
x4	

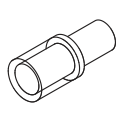

MANHATTAN RTV

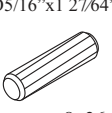
G20		B5	$\phi 19/32'' \times 15/32''$ 	A1	$\phi 5/16'' \times 1 27/64''$ 
x8		x8	$\phi 15 \times 12$	x8	$\phi 8 \times 36$

3  
x2

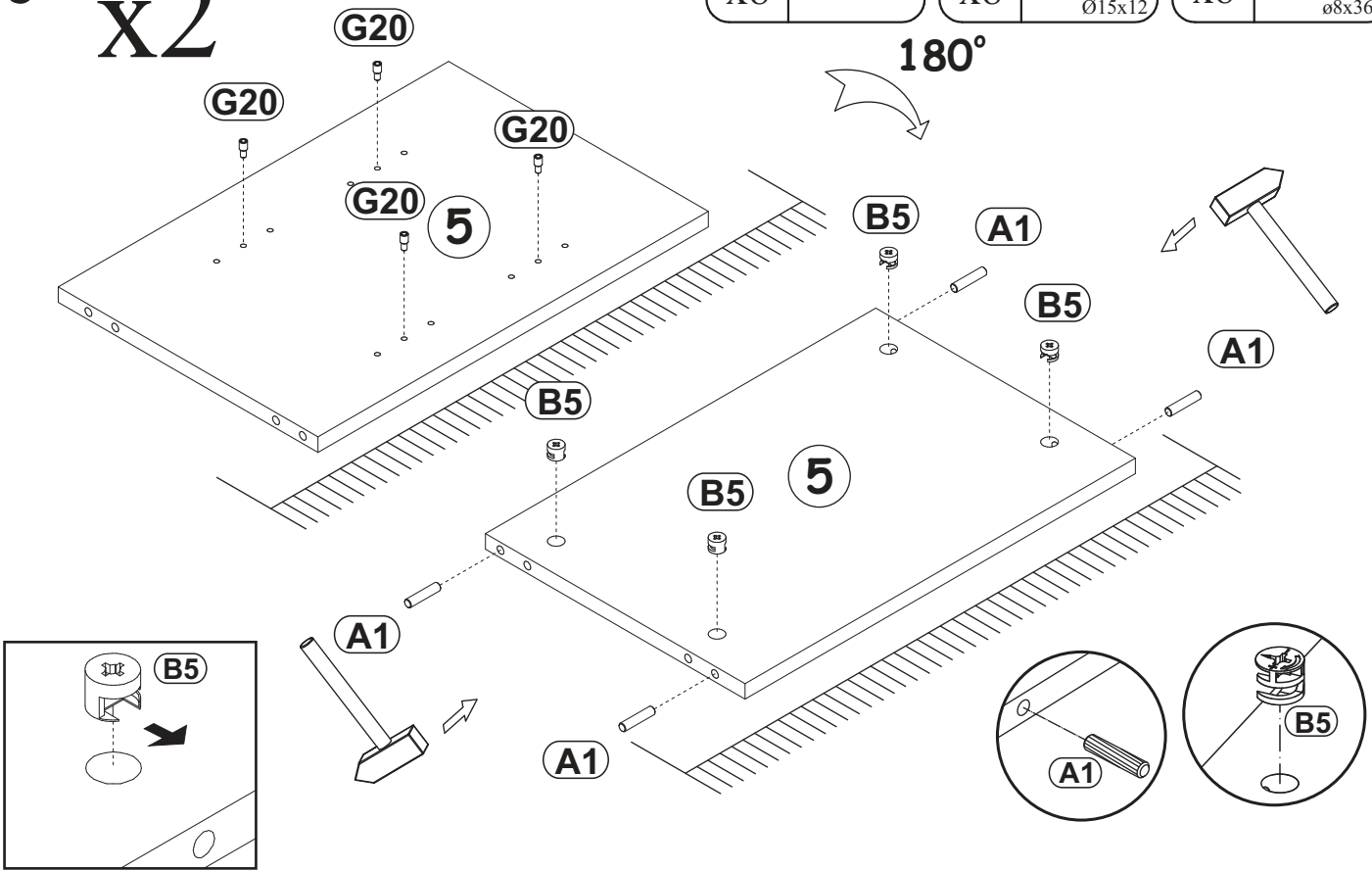

4

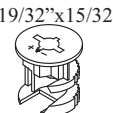
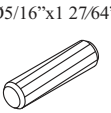
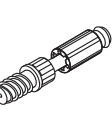
B5	$\phi 19/32'' \times 15/32''$ 	A1	$\phi 5/16'' \times 1 27/64''$ 	B4	
x4	$\phi 15 \times 12$	x4	$\phi 8 \times 36$	x4	

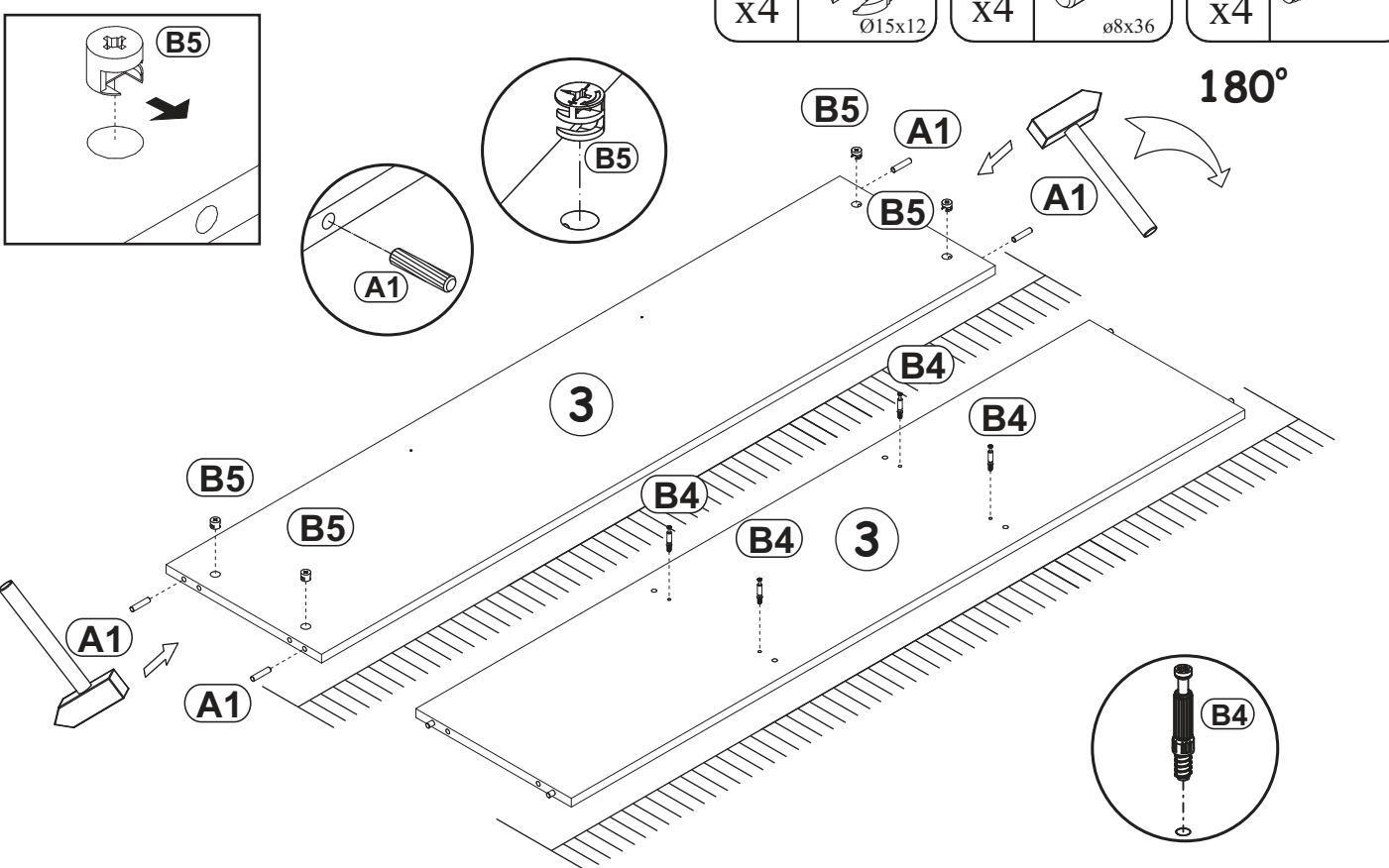

5

B4

x8

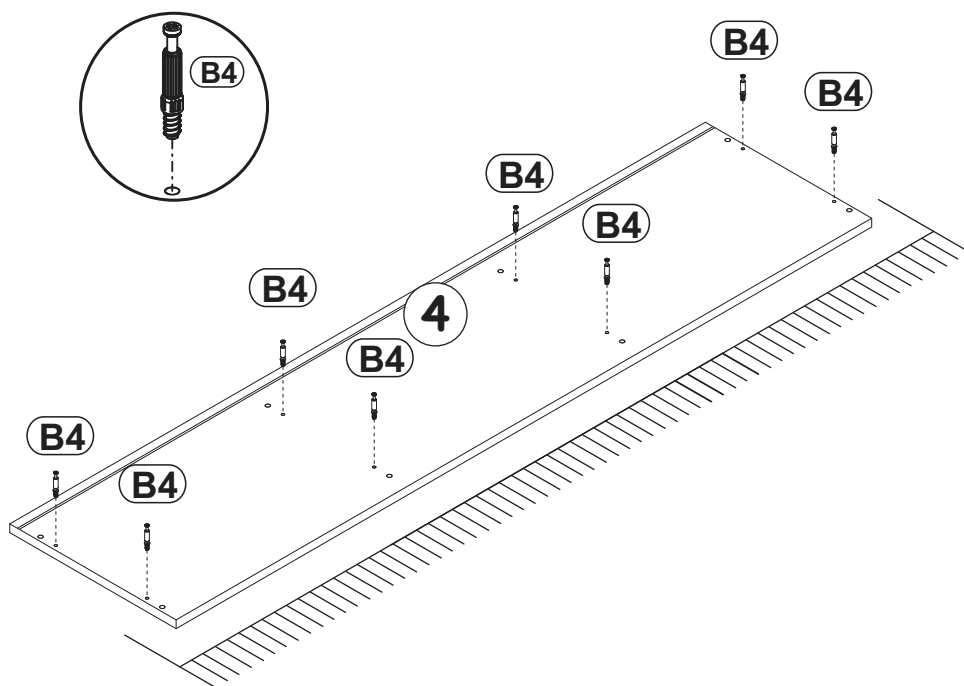
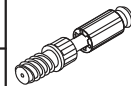

6

A1

x4

Ø5/16"x1 27/64"

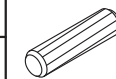

ø8x36

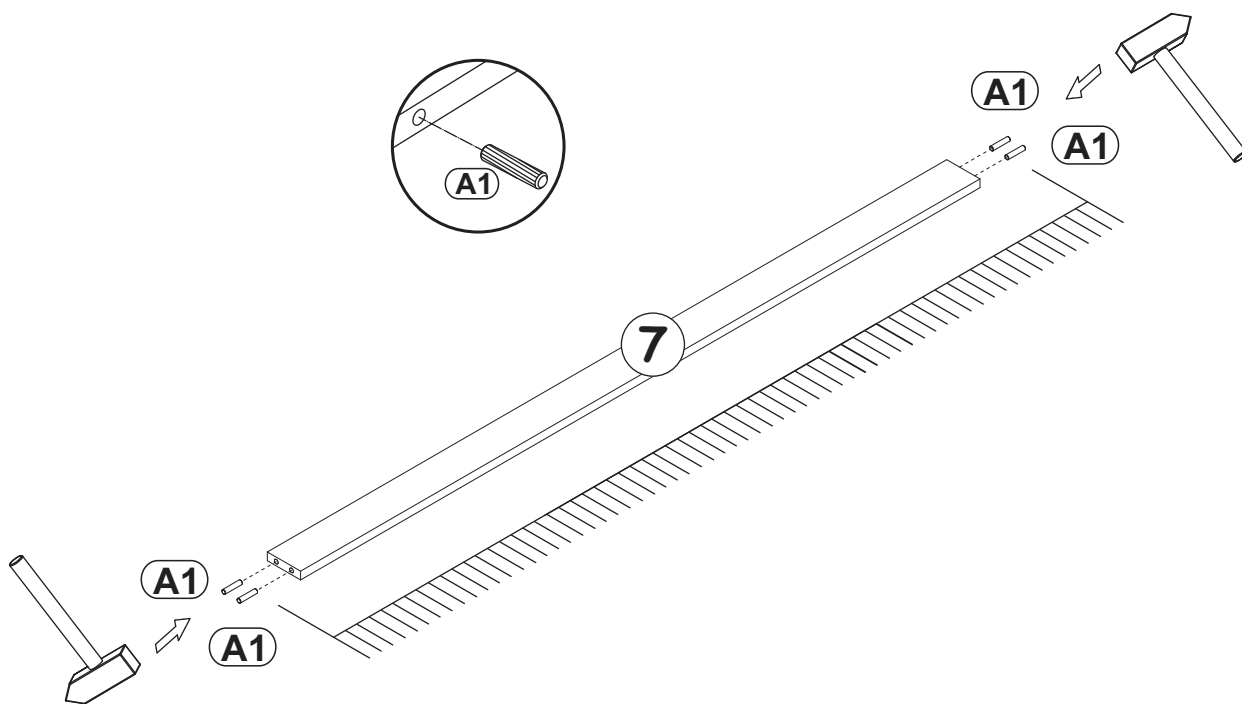

# MANHATTAN RTV

7

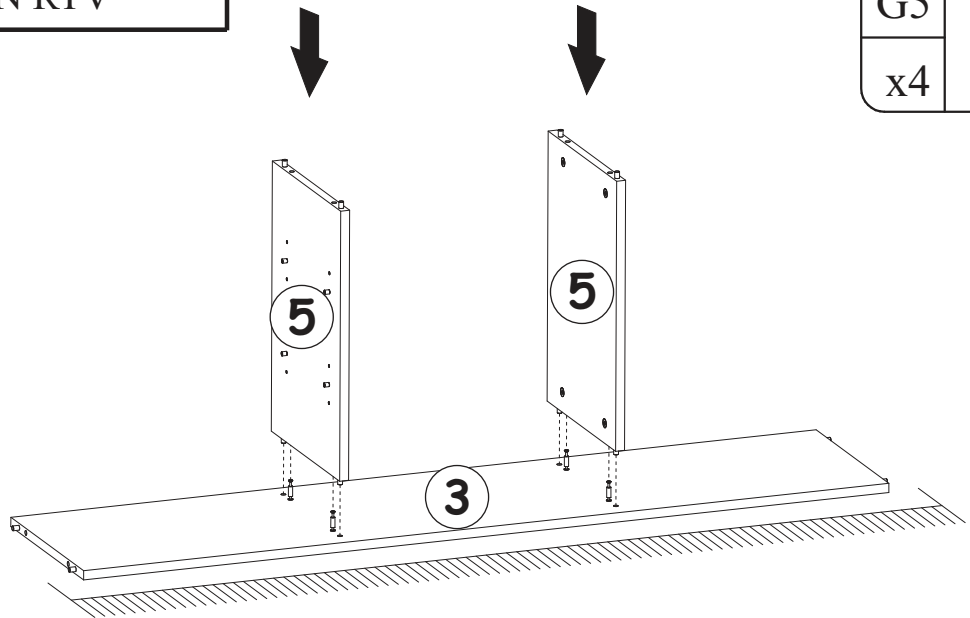
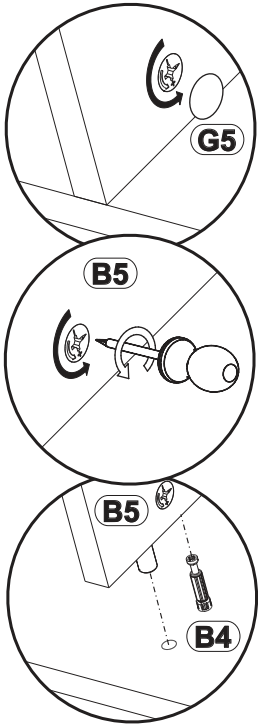

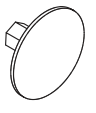
G5	
x4	

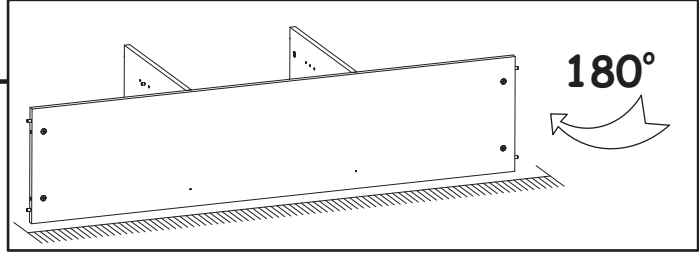
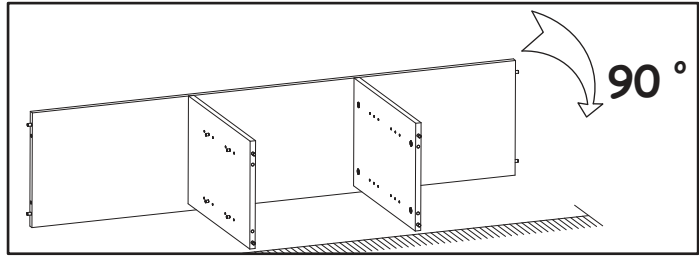

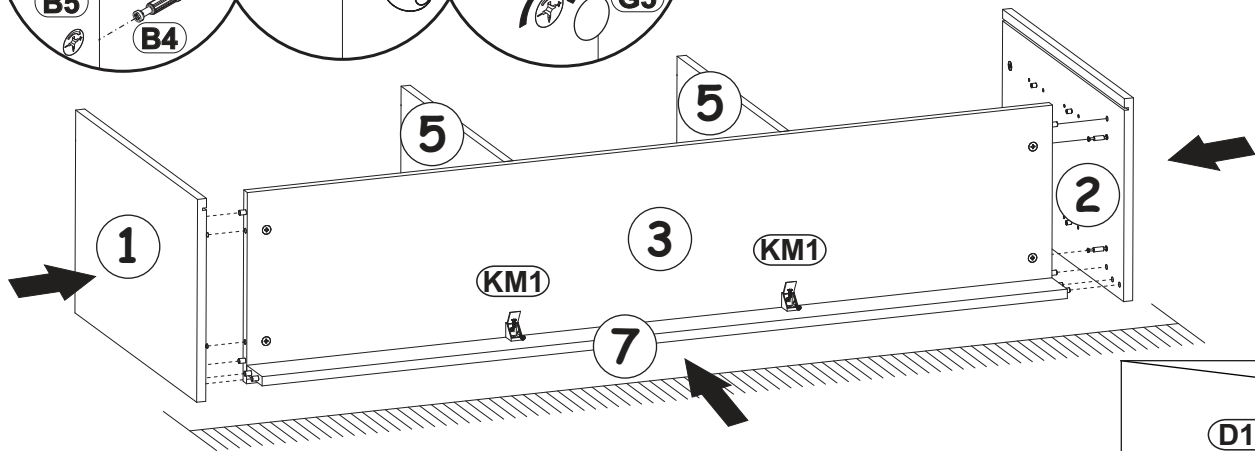
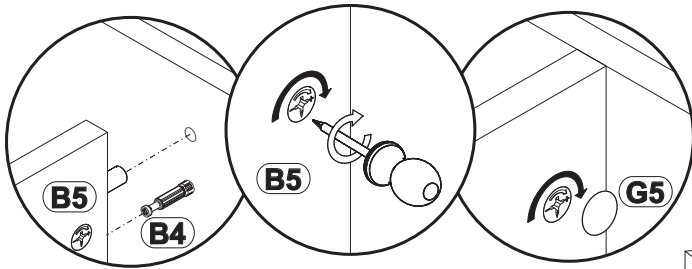

8

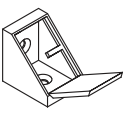

KM1	
x2	

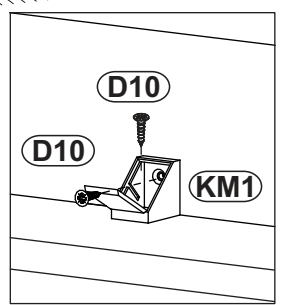
D10	USØ9/64"x33/64"
x4	USØ3,5x13



G5		I2	
x8		x6	

9

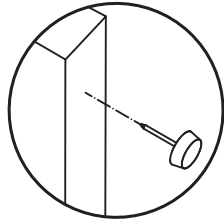
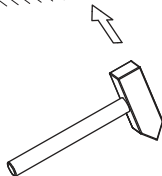
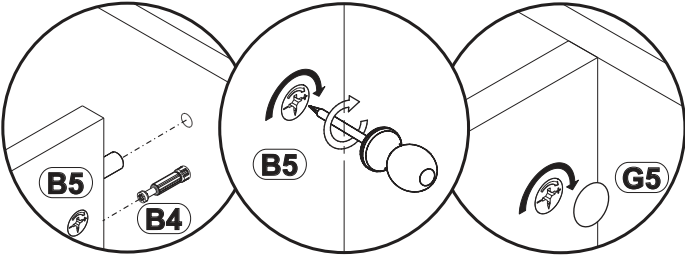
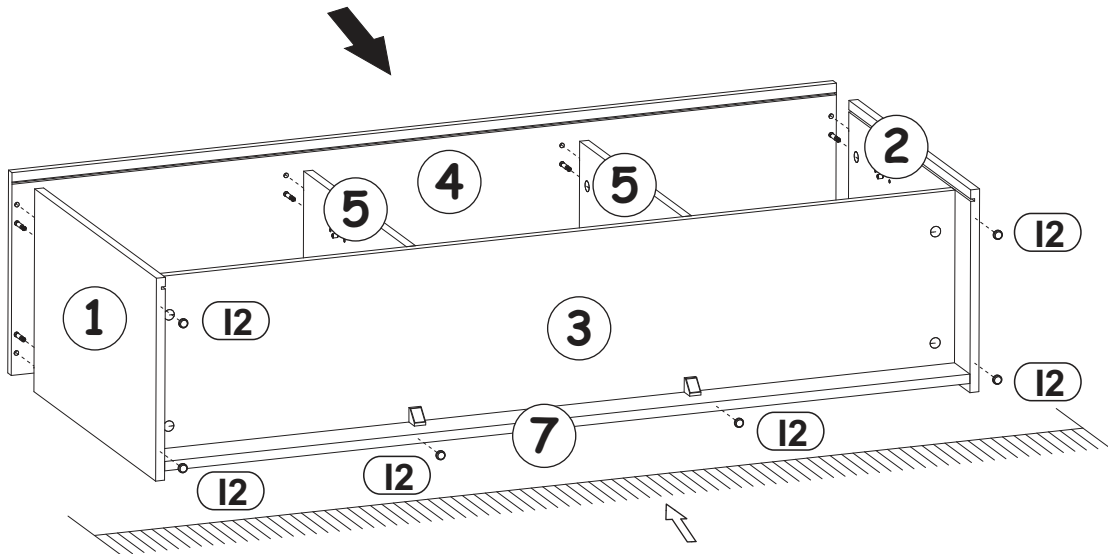

10

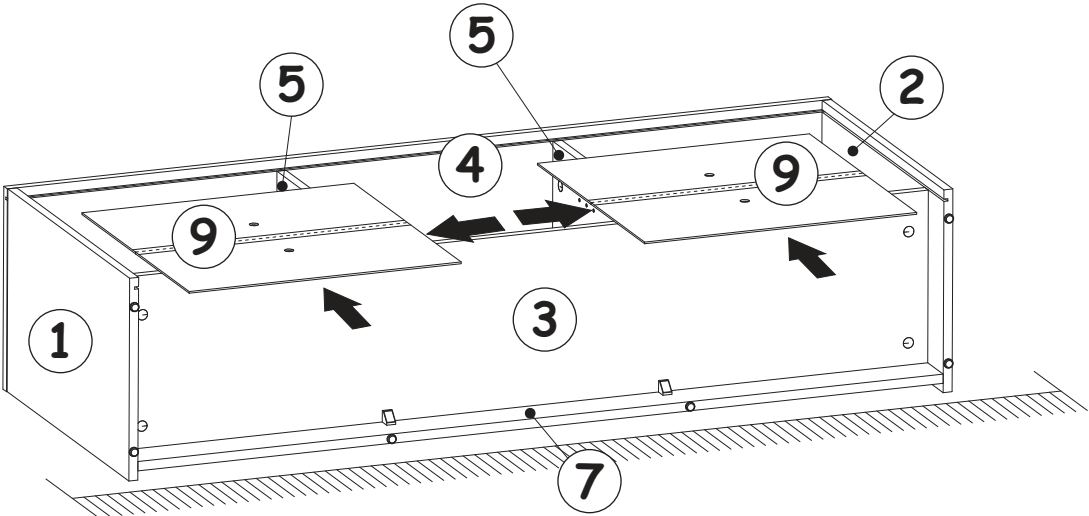

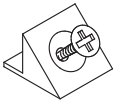

UP13	USØ1/8"x5/8"	S1	
x12	UPØ3x16	x8	

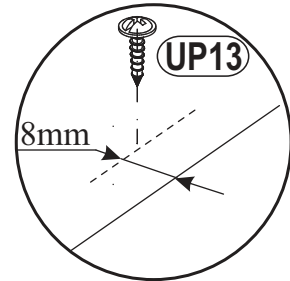
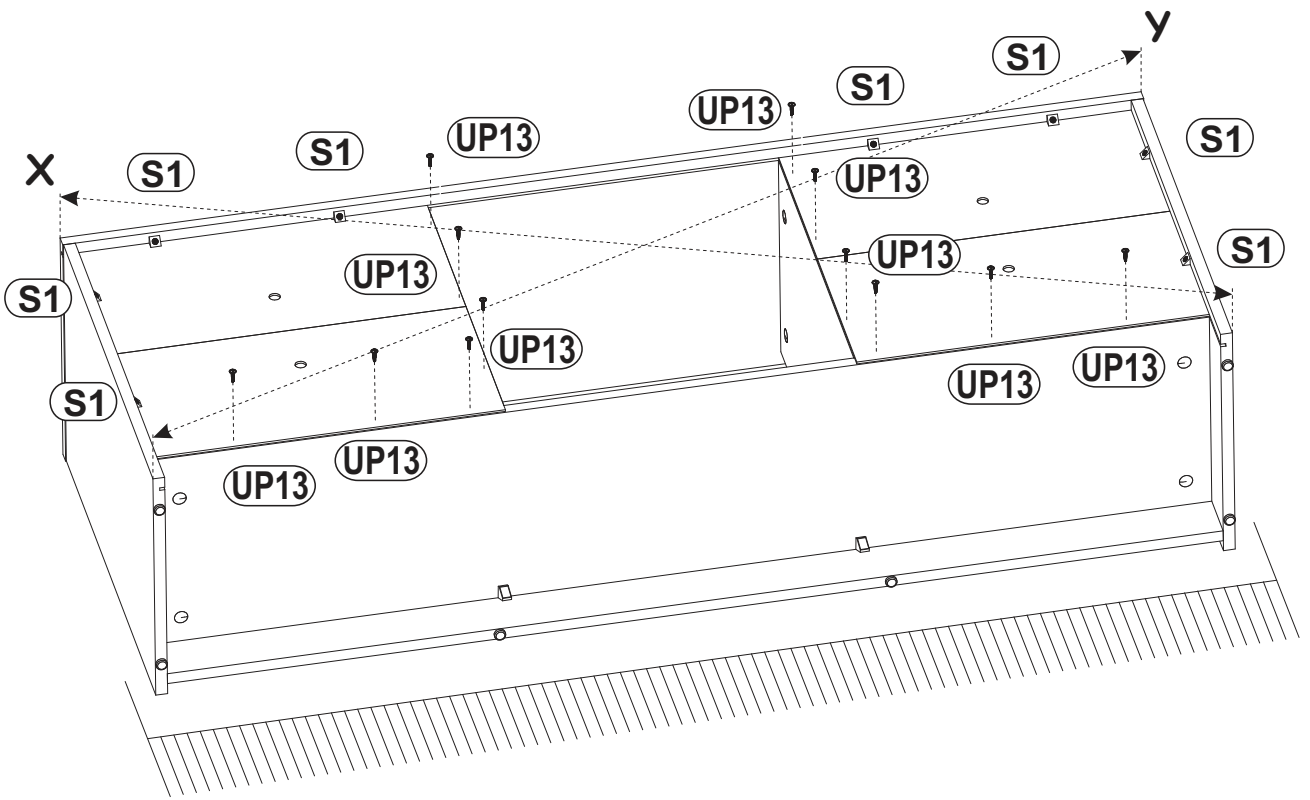
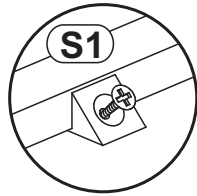
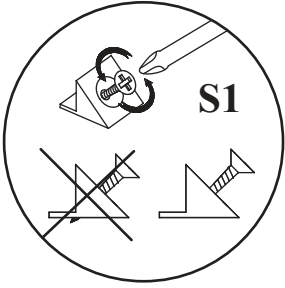
11







# MANHATTAN RTV

LZ3		LED	
x1		x4	

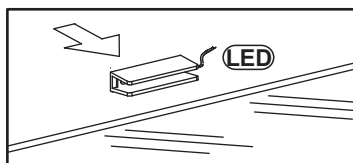
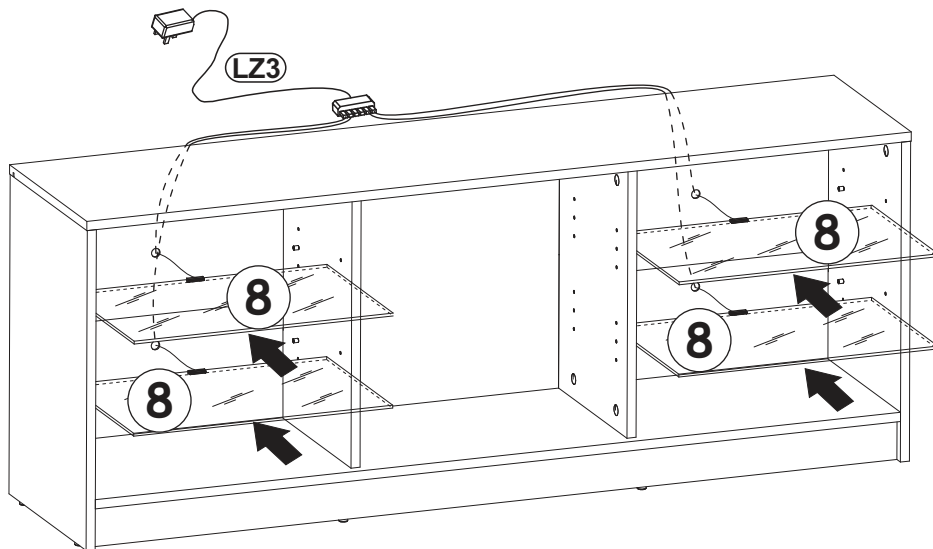
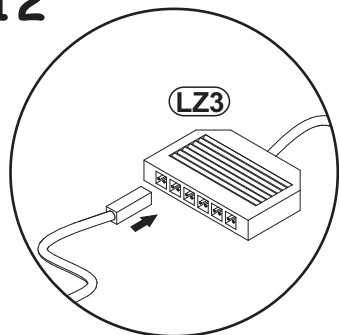
12



13

PE1	
x1	

