

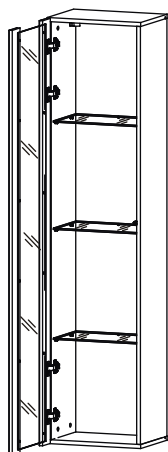

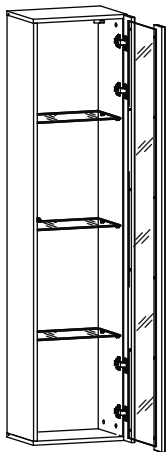

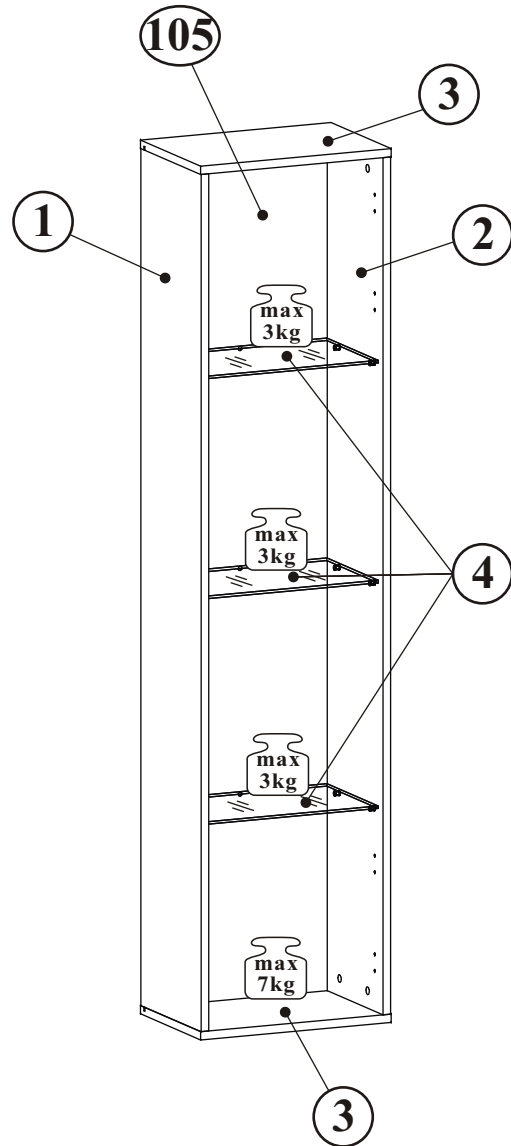

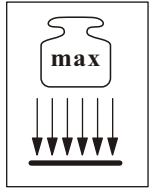

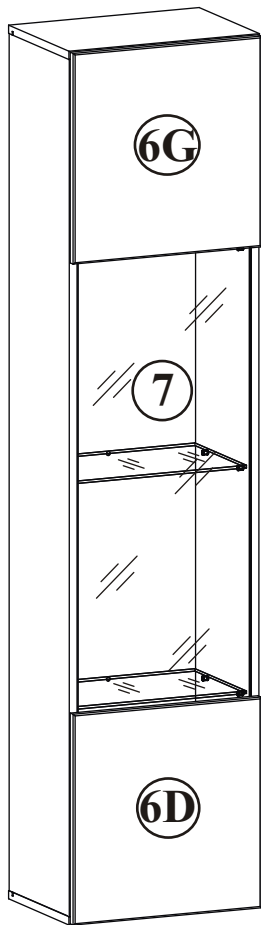
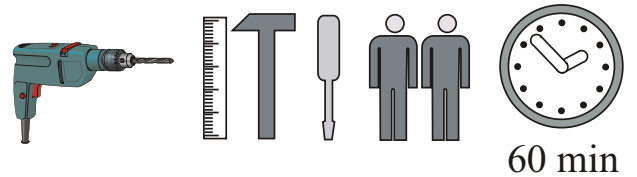

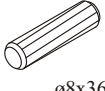
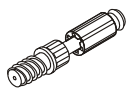

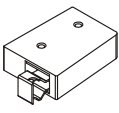
FLY 28 -- FY 42-C

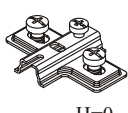
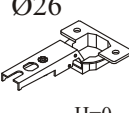

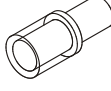
NO	Dim.		Col.-No	Qty
1	1668	274	1	1
2	1668	274	1	1
3	400	274	1	2
4	364	234	1	3
105	1680	378	1	1
6G	394	410	1	1
6D	394	410	1	1
7	925	362	1	1

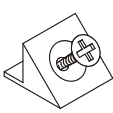
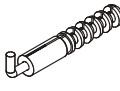

FLY 28--FY 42-C

A1 x8  ø8x36	B4 x8 	B5 x8  ø15x12	G5 x8 	ZR1 x2 	D6 x4  USØ3,5x30
E2 x4  H=0	E1 x4  Ø26 H=0	D10 x10  USØ3,5x13	AM x1 	G20 x12 	Z2 x8  Ø5
P2 x6 	UP13 x6  UPØ3x16	S1 x12 	KR2 x2 	G2 x1 	

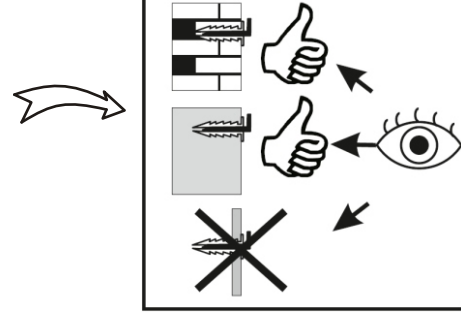
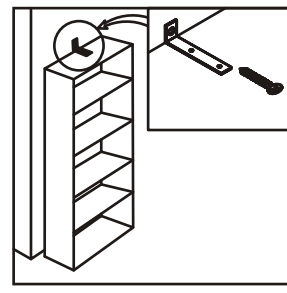
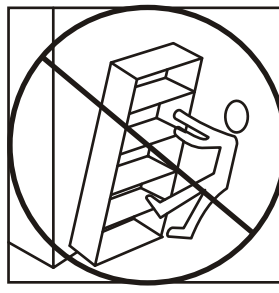
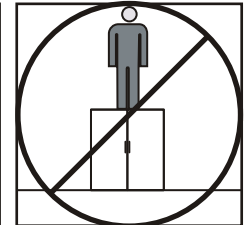
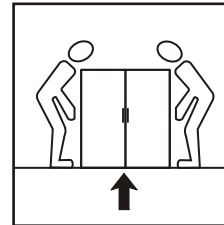
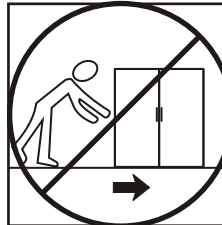
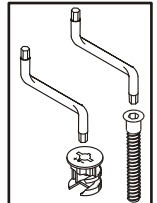
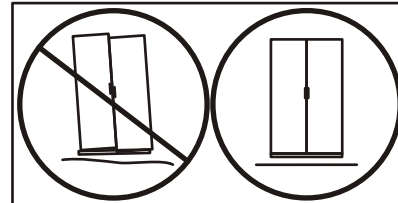
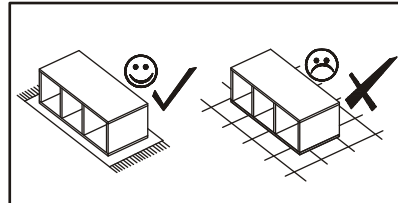
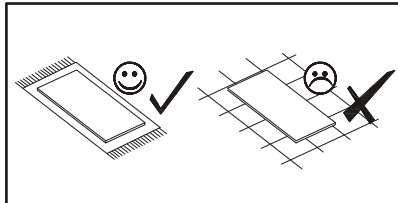
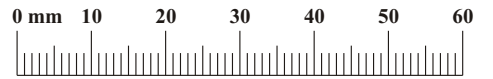

FLY 28--FY 42-C

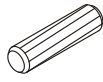
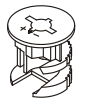
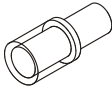
A1		B5		G20	
x8	ø8x36	x8	ø15x12	x12	

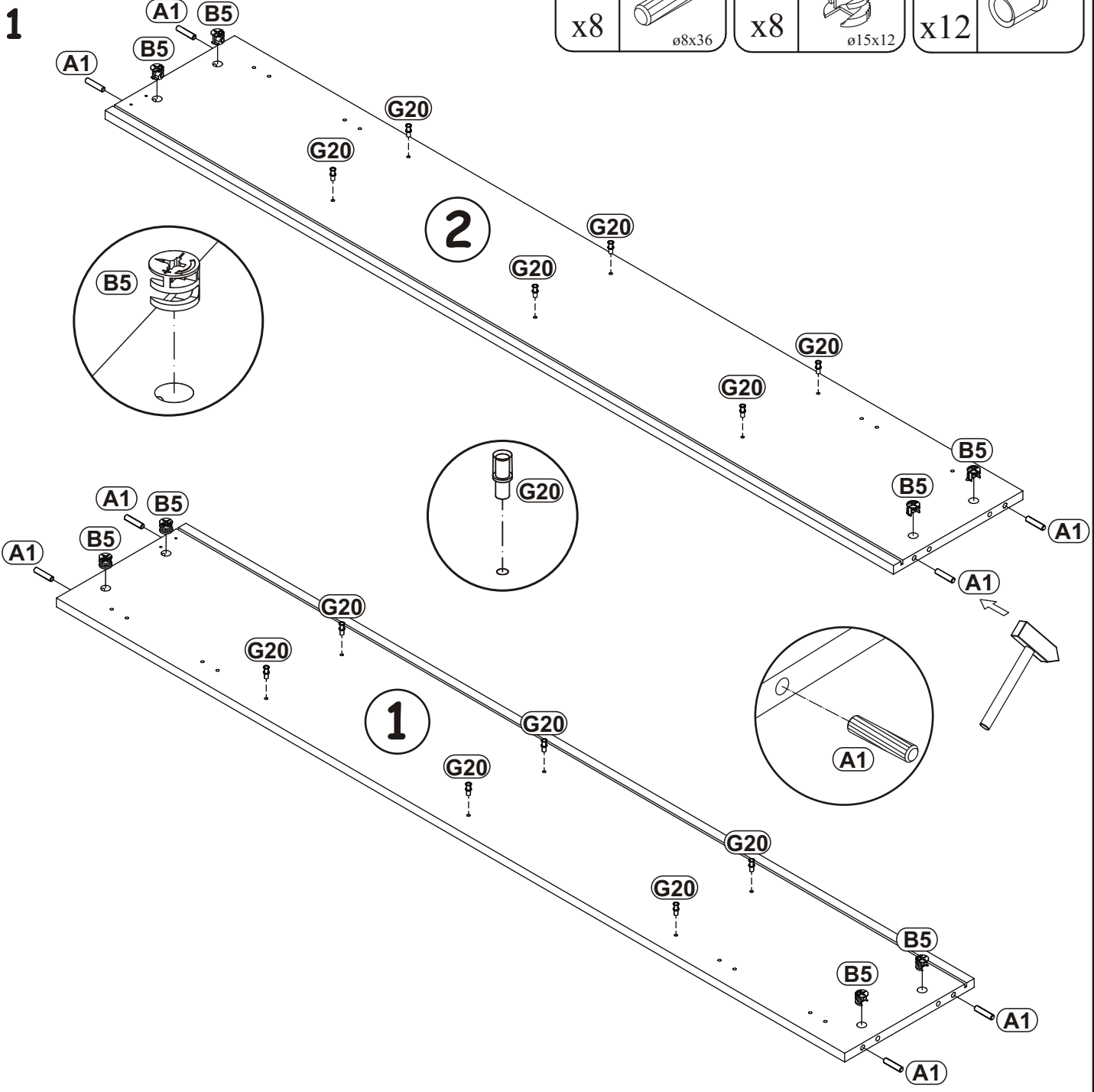

2

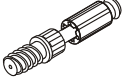
B4	
x8	

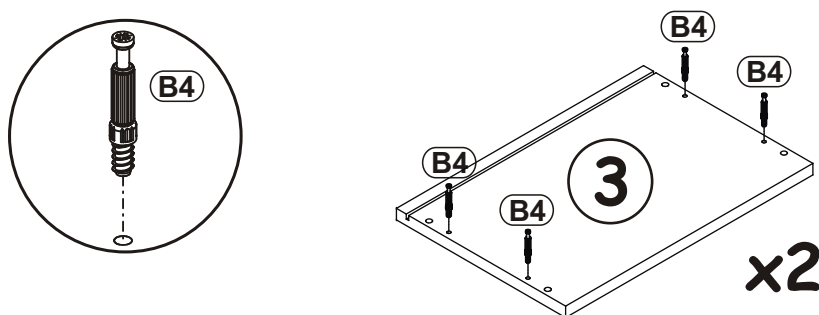

FLY 28--FY 42-C

3

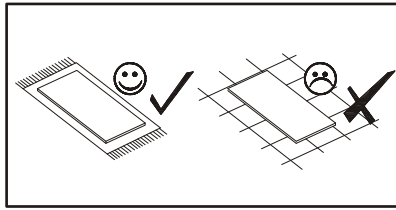

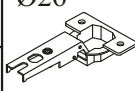
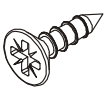
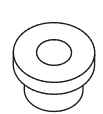
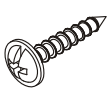

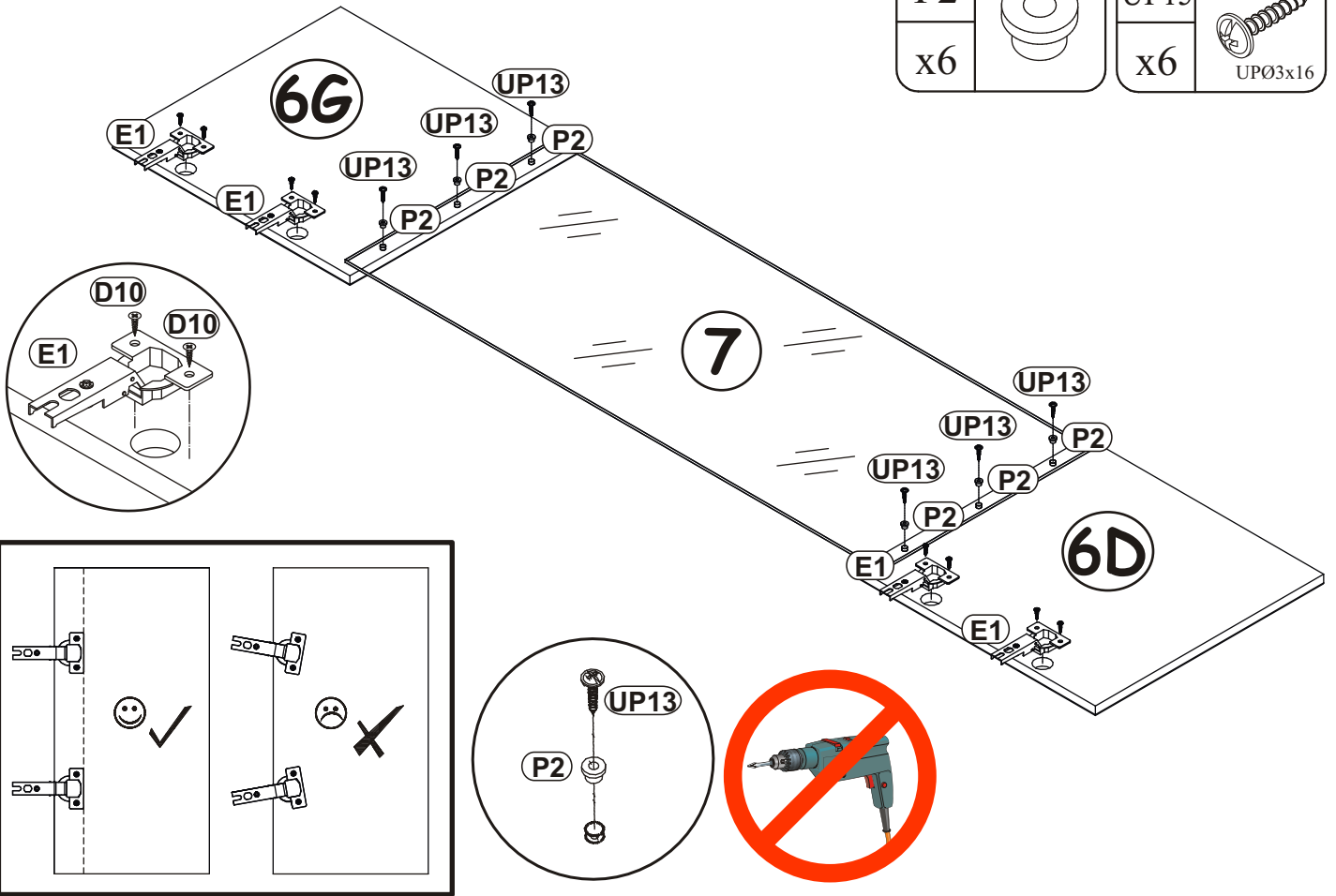
E1	Ø26	D10	
x4	 H=0	x8	 USØ3,5x13
P2		UP13	
x6		x6	 UPØ3x16

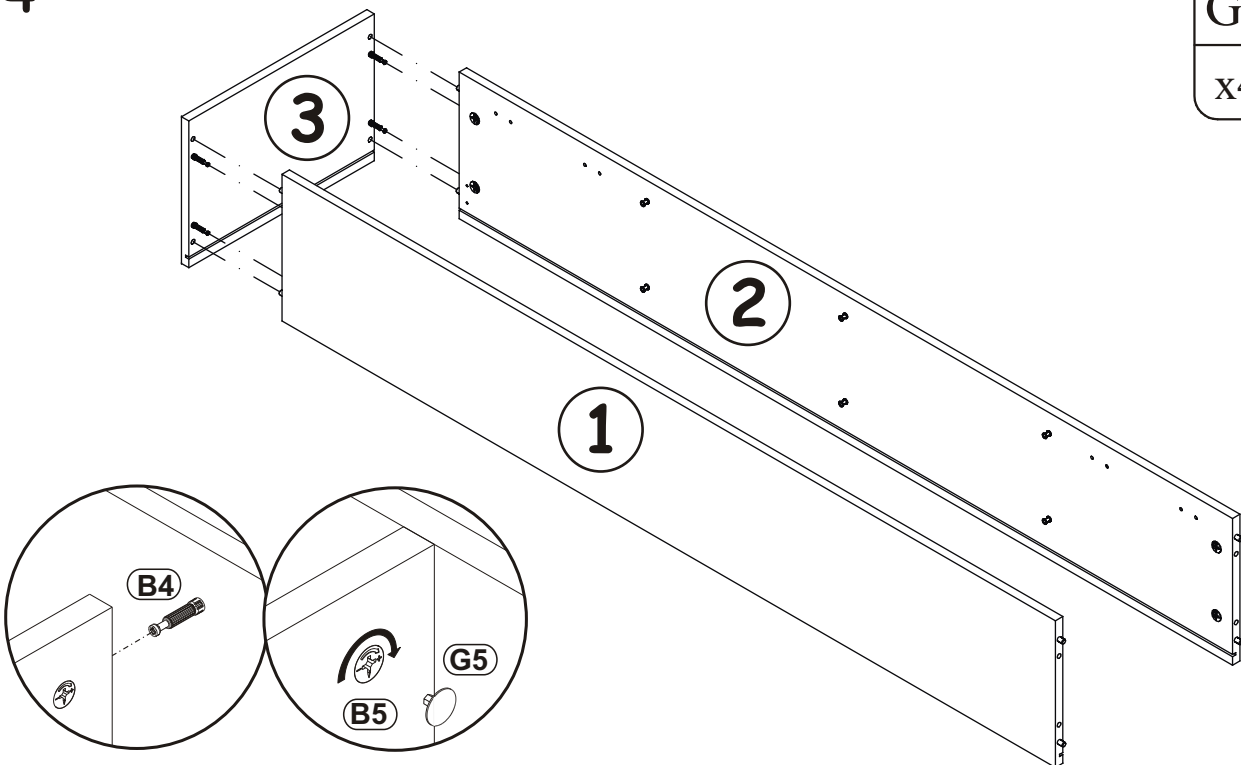

4

G5	
x4	



G5	
x4	

5

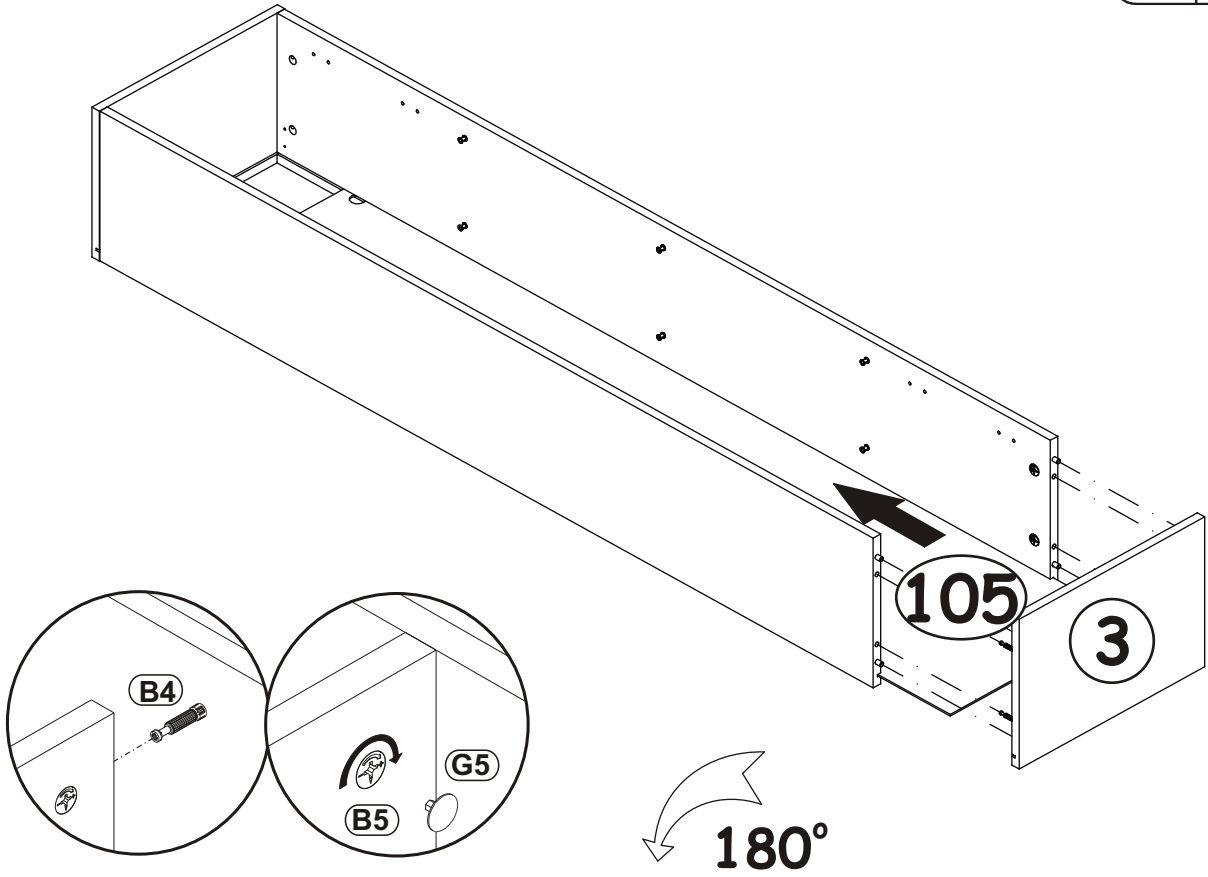

6

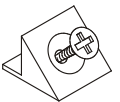

S1	
x12	

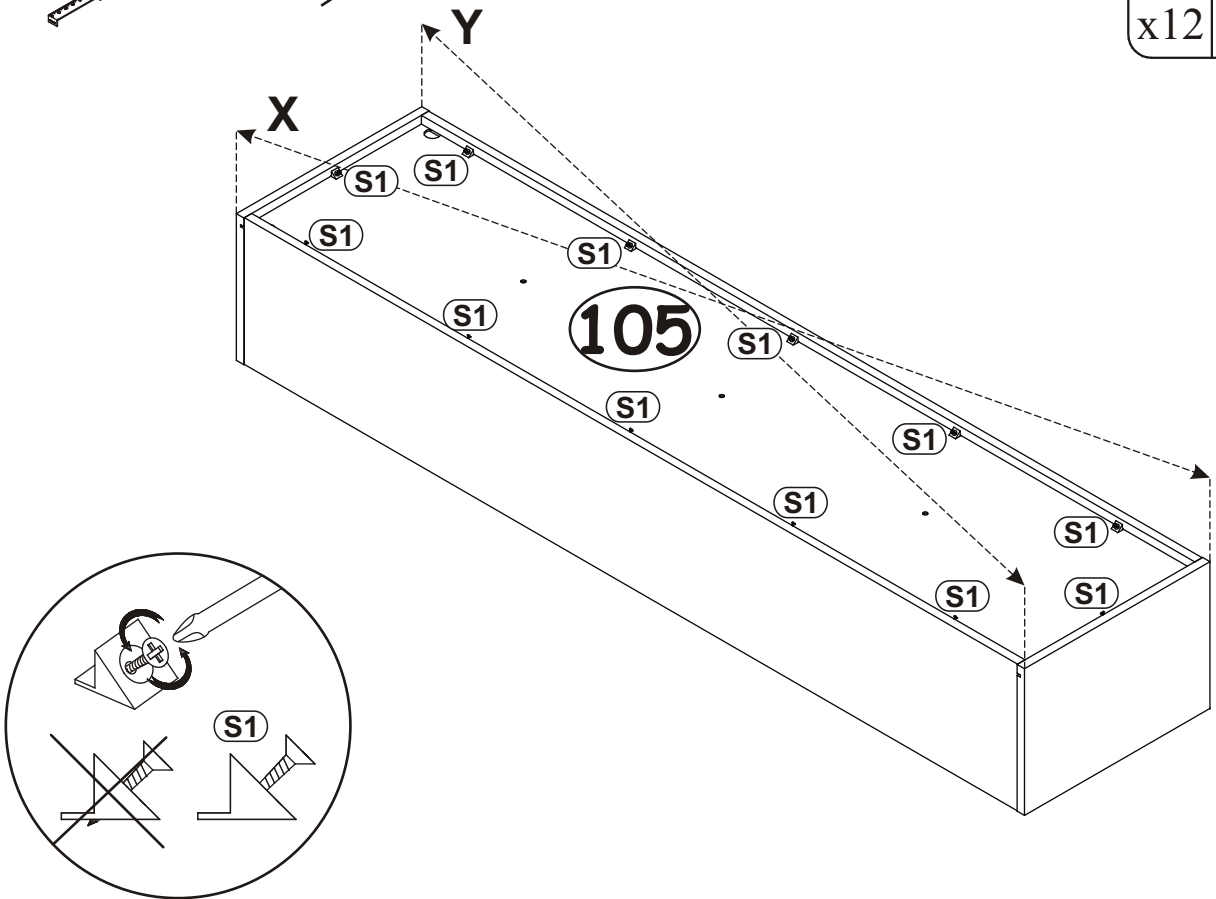

FLY 28--FY 42-C

7

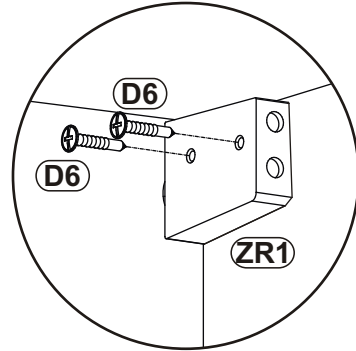
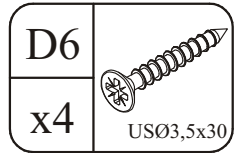
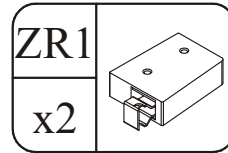
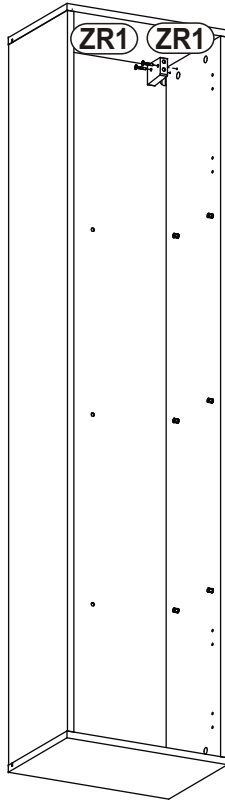
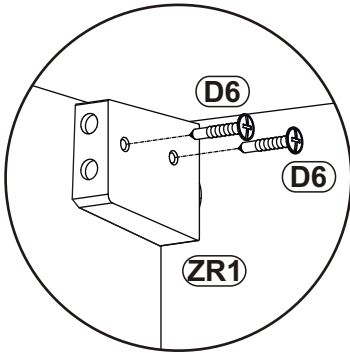

8

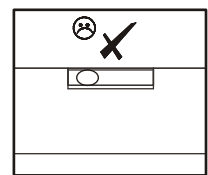
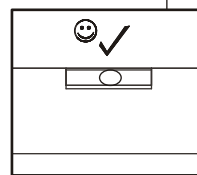
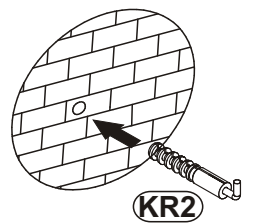
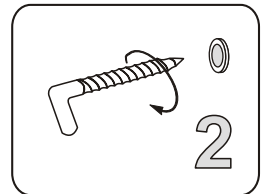
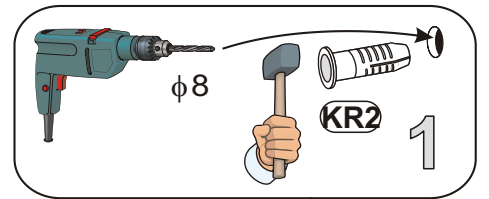
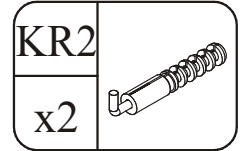
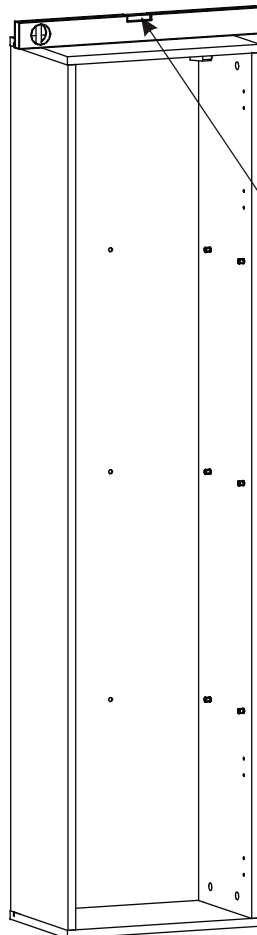
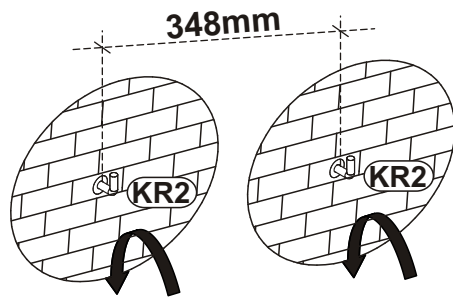
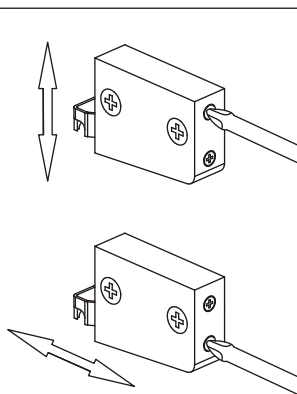
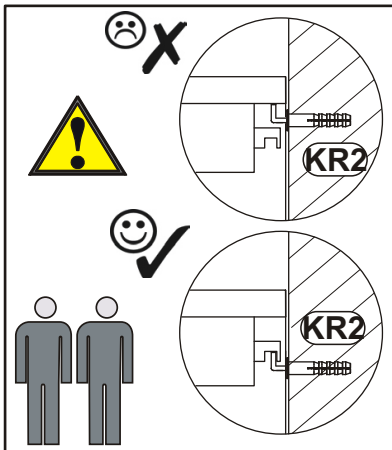
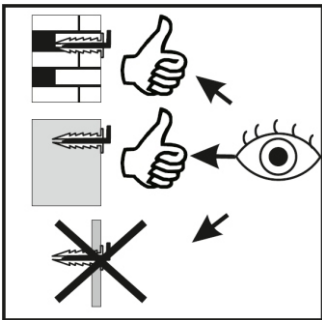

9-10

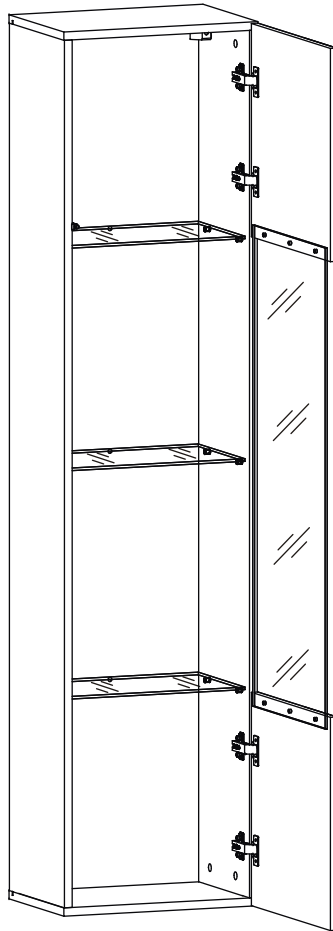

11-12

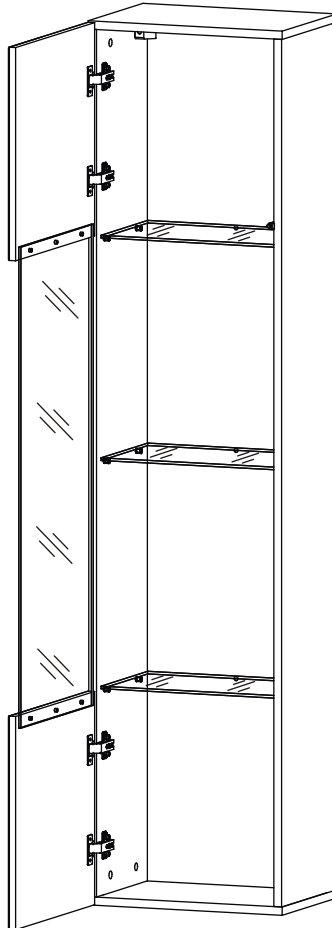

9

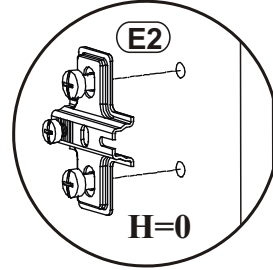
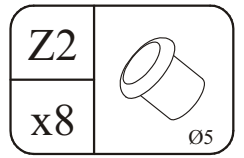
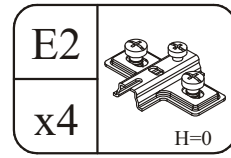
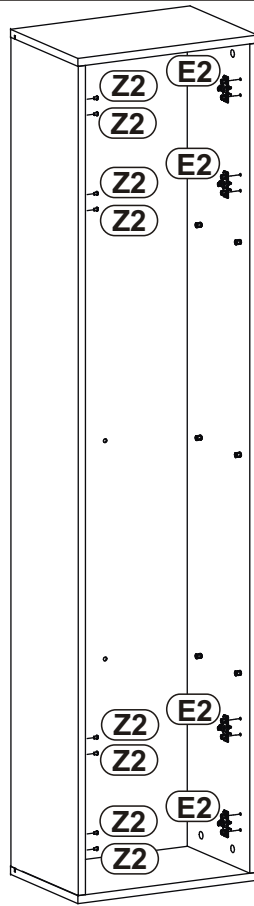
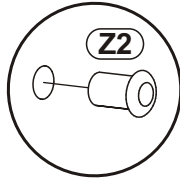
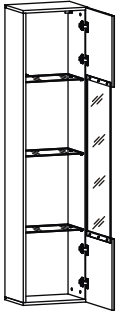

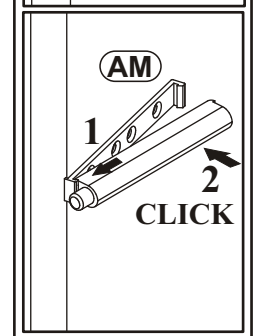
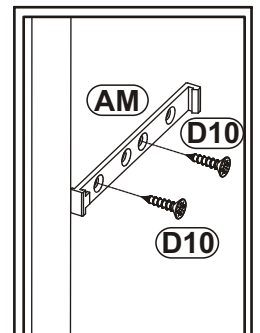
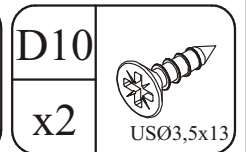
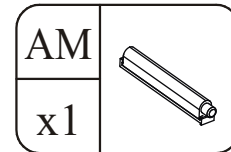
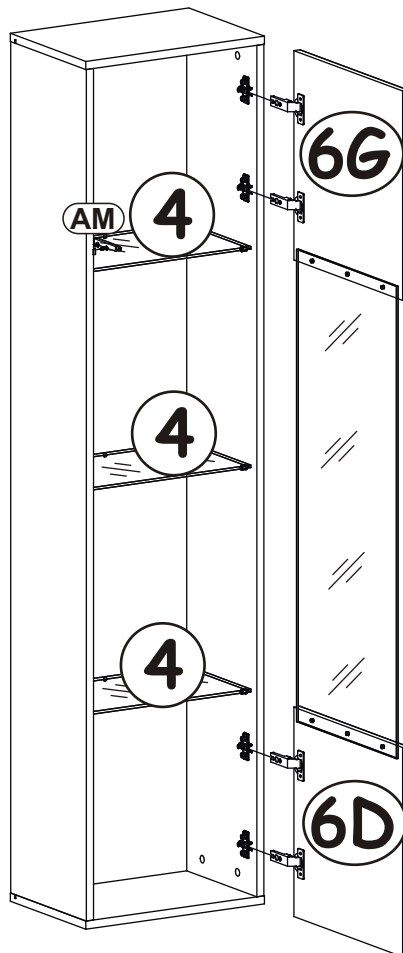
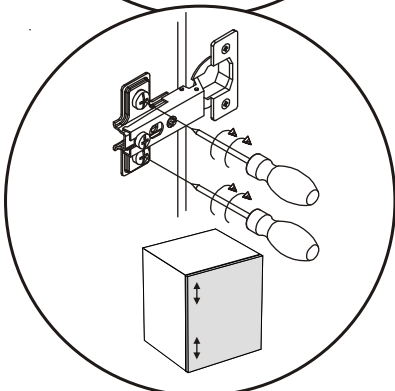
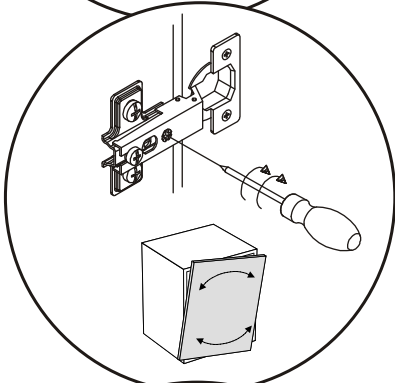
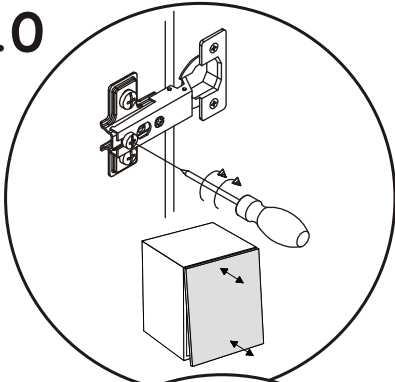

10

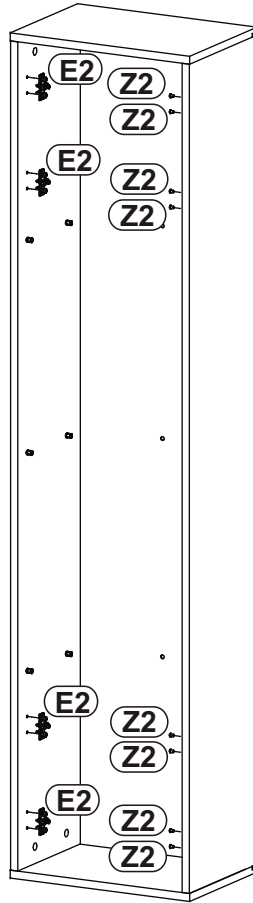
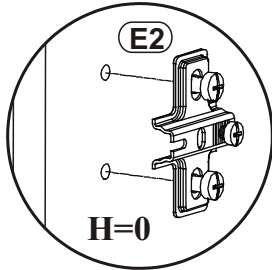
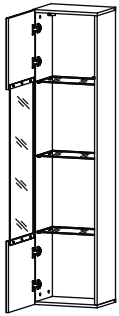

11

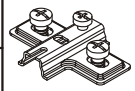

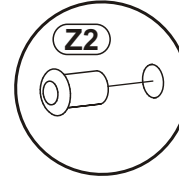

E2		Z2	
x4	H=0	x8	Ø5

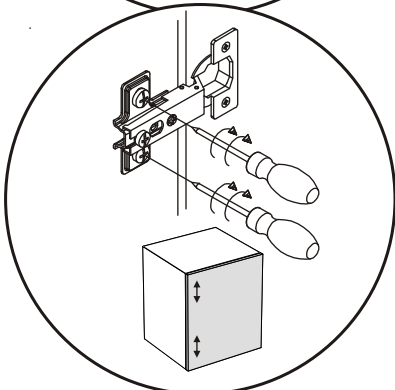
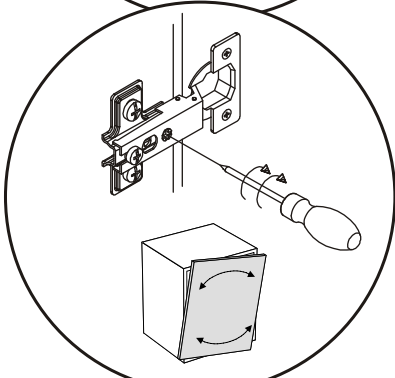
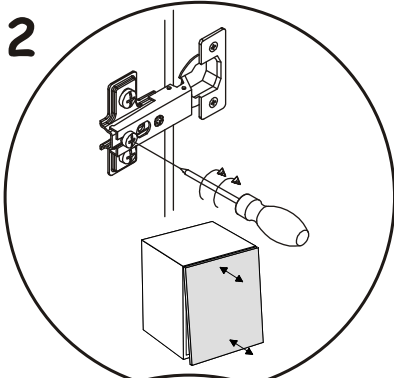

12

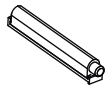

AM		D10	
x1		x2	USØ3,5x13

