

FLY 28 -- FY 34-C

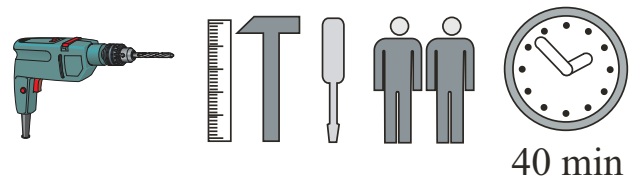

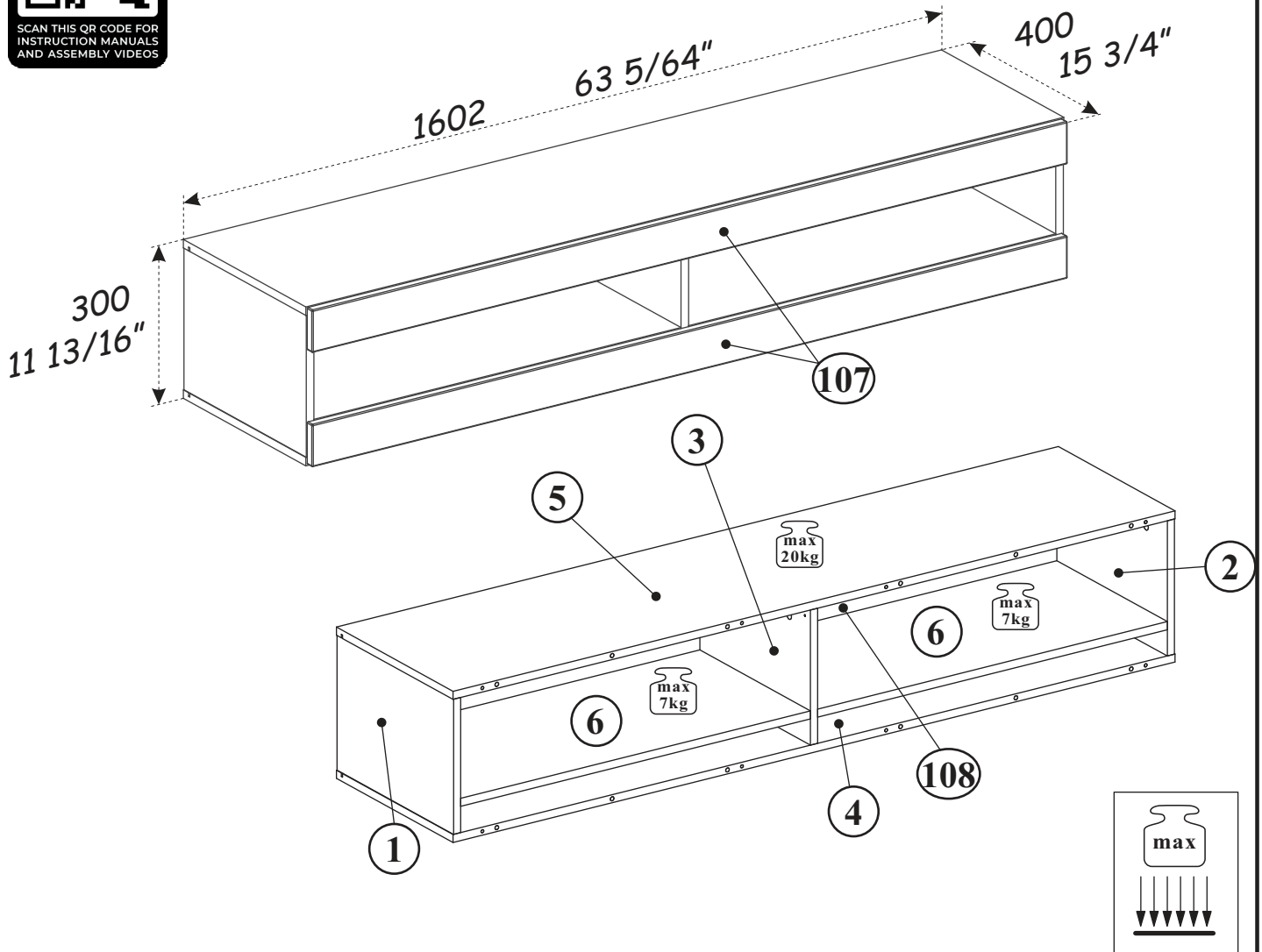

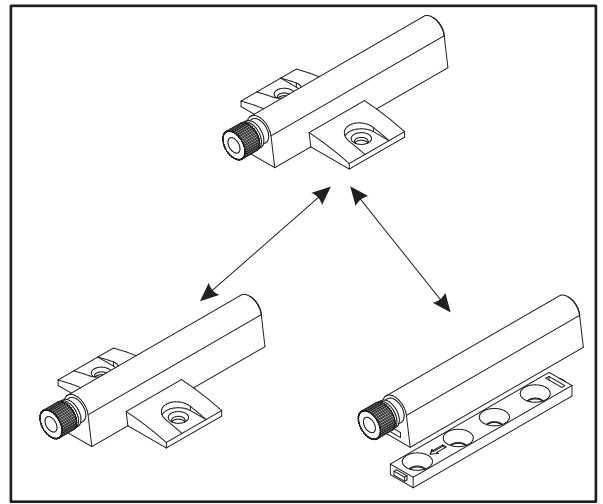

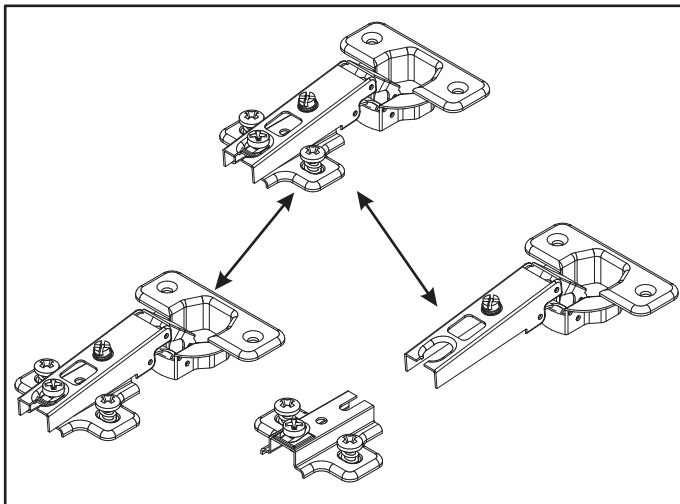
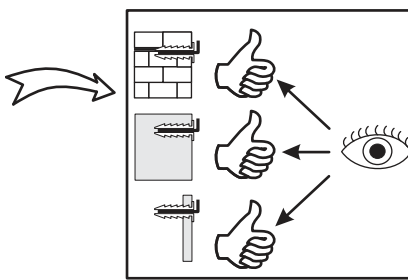
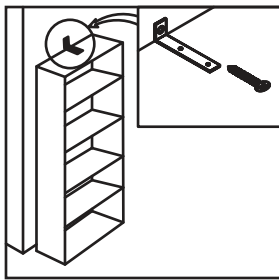
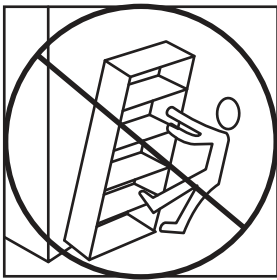
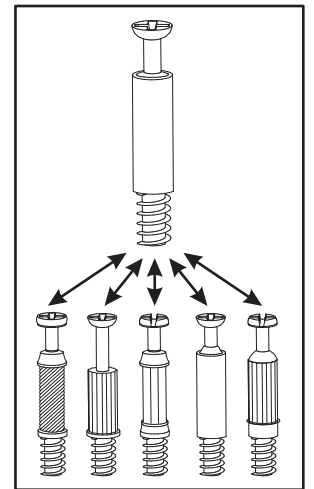
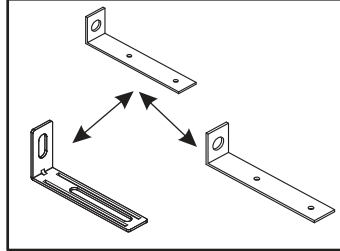
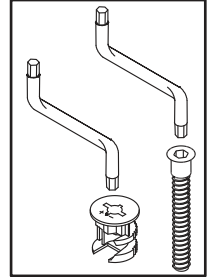
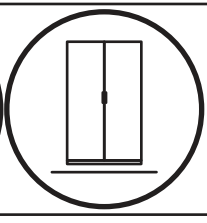
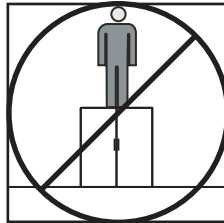
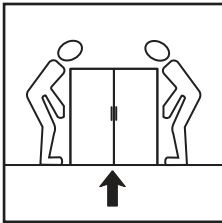
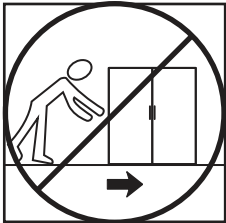
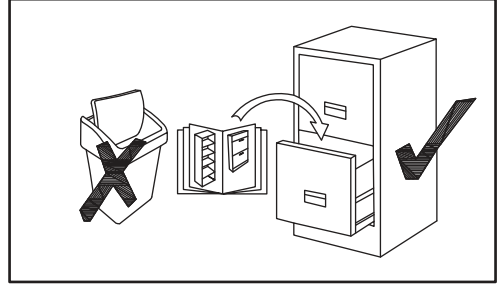
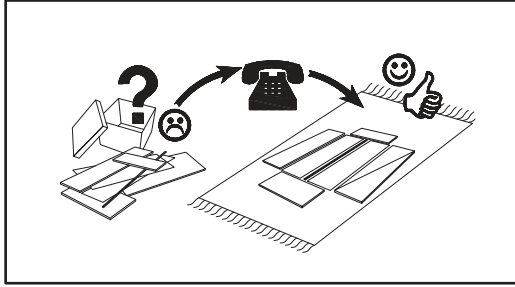
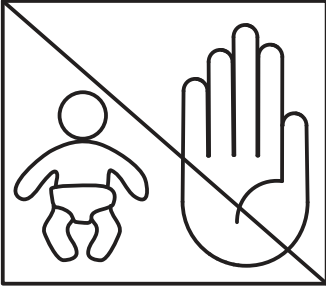
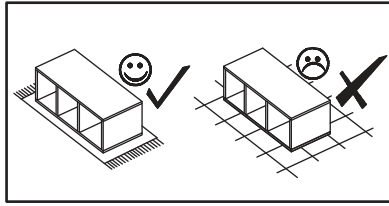
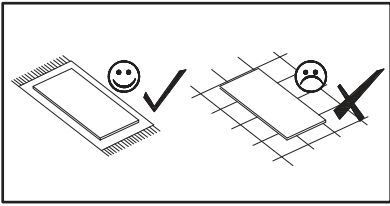



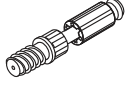

NO	Dim.			Col.-No	Qty
1	268	384	16	1	1
2	268	384	16	1	1
4	1602	384	16	1	1
5	1602	384	16	1	1
3	268	364	16	1	1
6	776	364	16	1	2
108	1580	280	3	1	1
107	1596	80	16	1	2

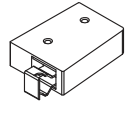
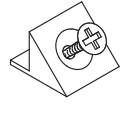
NO	Dim.			Col.-No	Qty
1	10 35/64	15 1/8	5/8	1	1
2	10 35/64	15 1/8	5/8	1	1
4	63 5/64	15 1/8	5/8	1	1
5	63 5/64	15 1/8	5/8	1	1
3	10 35/64	14 21/64	5/8	1	1
6	30 35/64	14 21/64	5/8	1	2
108	62 13/64	11 1/32	1/8	1	1
107	62 53/64	3 5/32	5/8	1	2

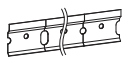

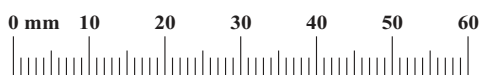
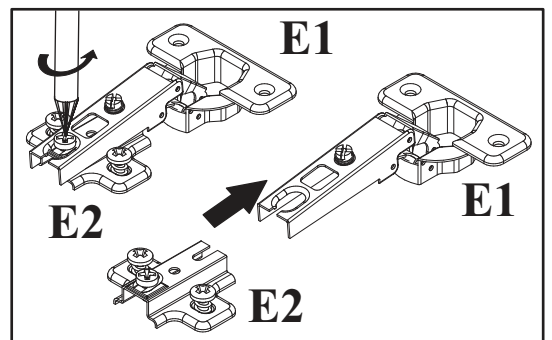

FLY 28--FY 34-C

A1 x20	$\varnothing 5/16'' \times 1 27/64''$  $\varnothing 8 \times 36$	B4 x28		B5 x32	$\varnothing 19/32'' \times 15/32''$  $\varnothing 15 \times 12$	G5 x32		A4 x8	$\varnothing 15/64'' \times 1 27/64''$  $\varnothing 6 \times 36$	G2 x1	
ZR1 x3		S1 x10		KR5 SFXP x4	$\varnothing 25/64'' / 1 31/32'' \times 2 23/64''$  $\varnothing 10 / 50 \times 60$	SZ9 x1	$L = 61 37/64''$  $L = 1564 \text{mm}$	D6 x6	$US \varnothing 9/64'' \times 1 3/16''$  $US \varnothing 3,5 \times 30$	B6 x2	$\varnothing 9/32'' \times 3 5/64''$  $\varnothing 7 \times 78$
LZ3 x1		SQ x2									

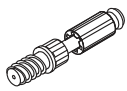

A1	Ø5/16"x1 27/64"
x16	 ø8x36

B4	
x4	

B5	Ø19/32"x15/32"
x16	 ø15x12

1

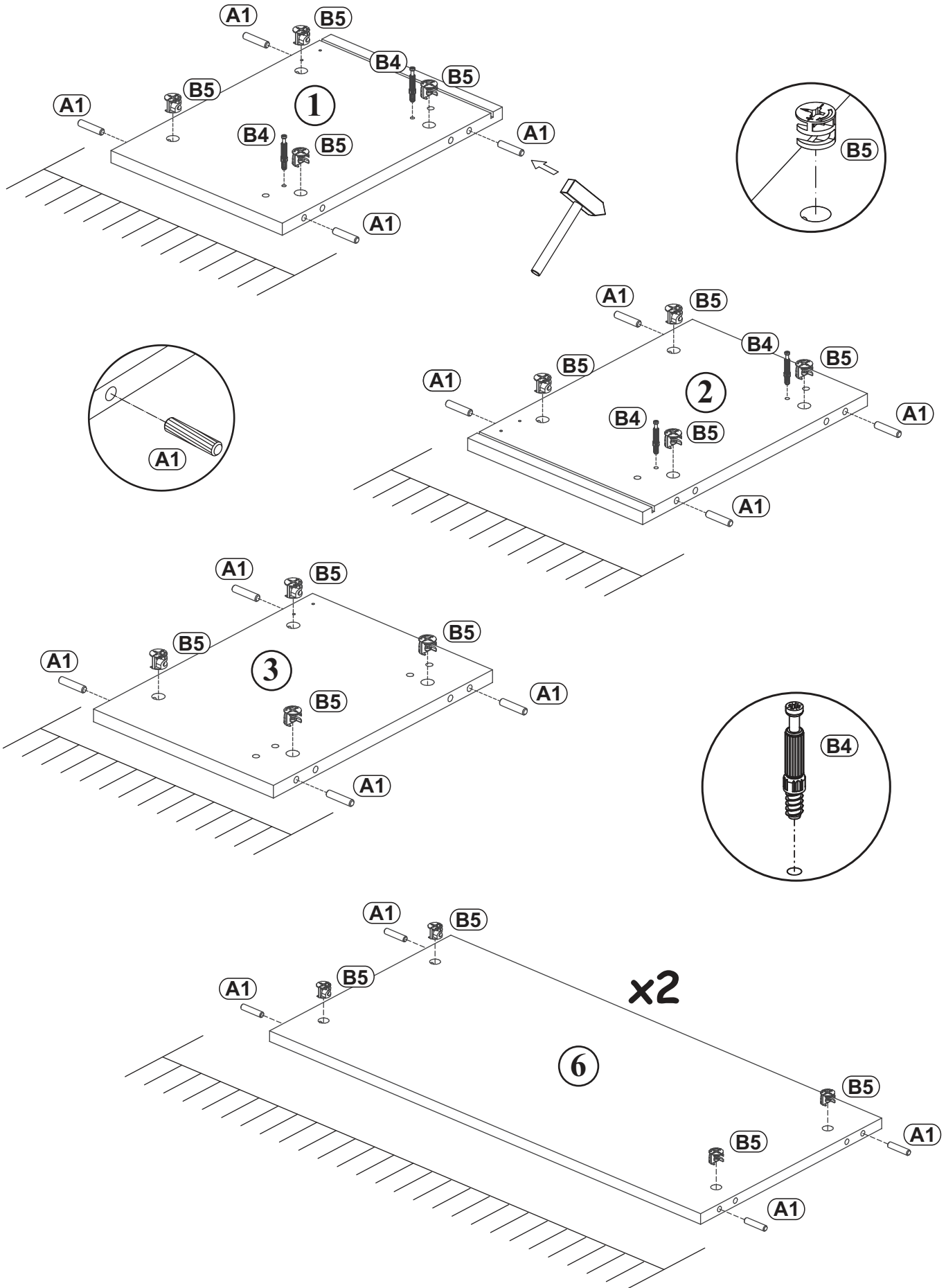

FLY 28--FY 34-C

2

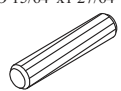

A4	Ø 15/64" x 1 27/64"
x4	Ø6x36

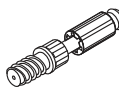

B4
x18

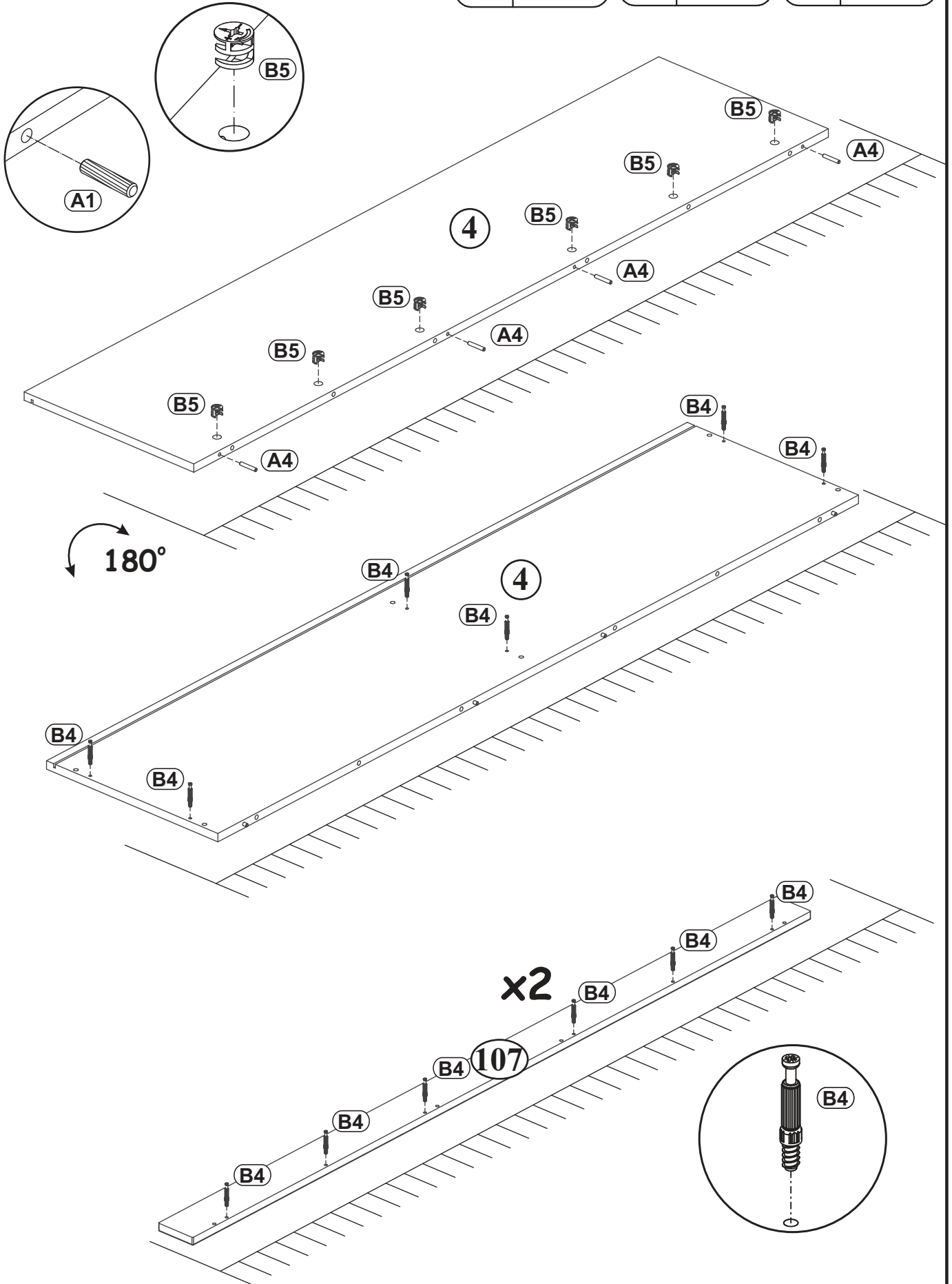

B5	Ø19/32" x 15/32"
x6	Ø15x12





FLY 28--FY 34-C

3

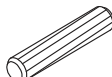
SQ	
x2	

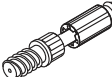
A4	 Ø 15/64" x 1 27/64"
x4	

B4	
x6	

B5	 Ø 19/32" x 15/32"
x6	

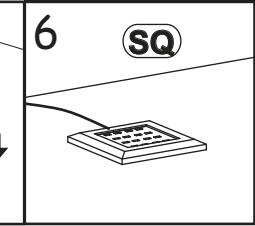
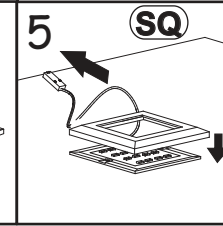
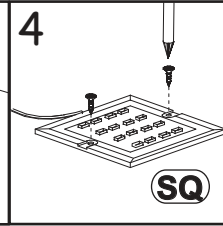
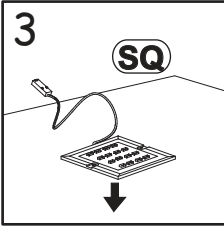
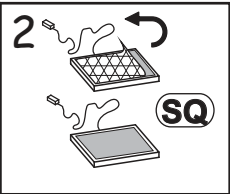
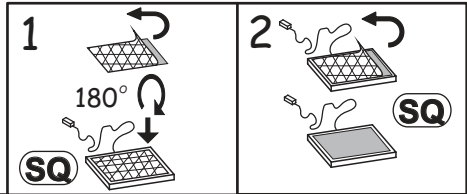
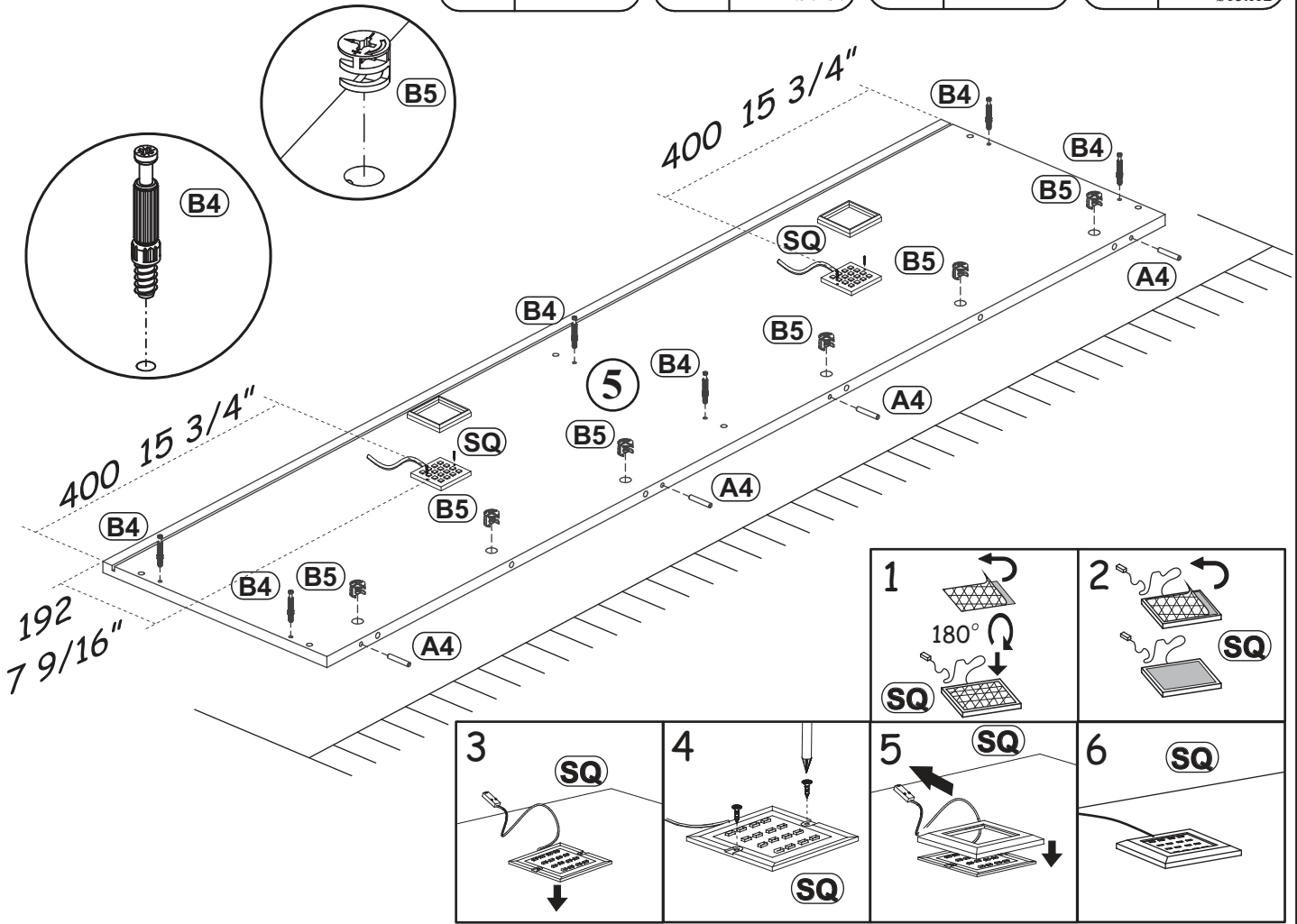

4

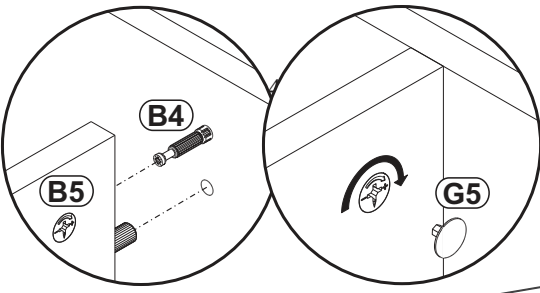

G5	
x8	

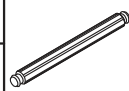
B6	 Ø 9/32" x 3 5/64"
x2	

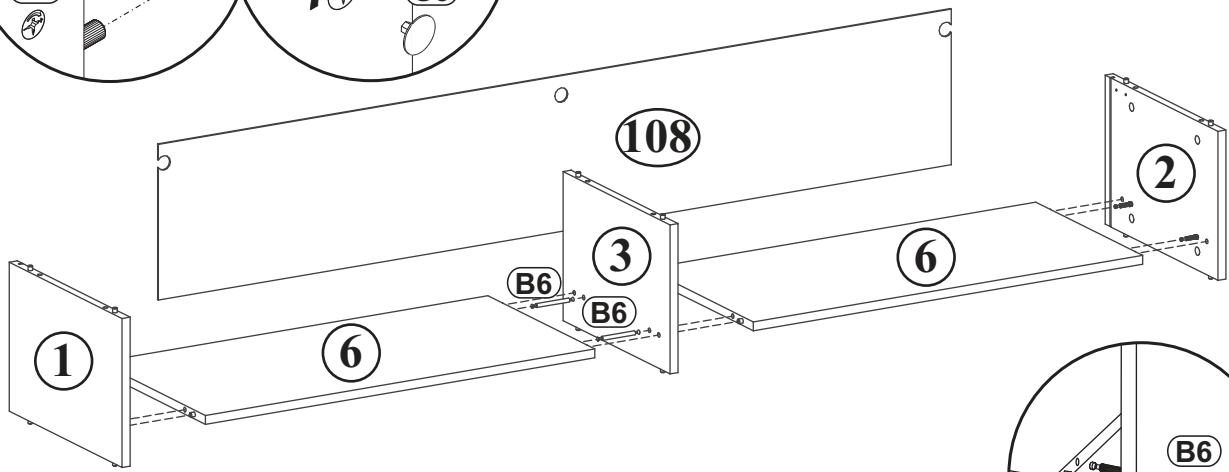

90°

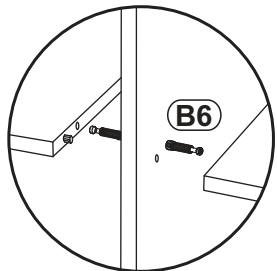

G5

x12



5

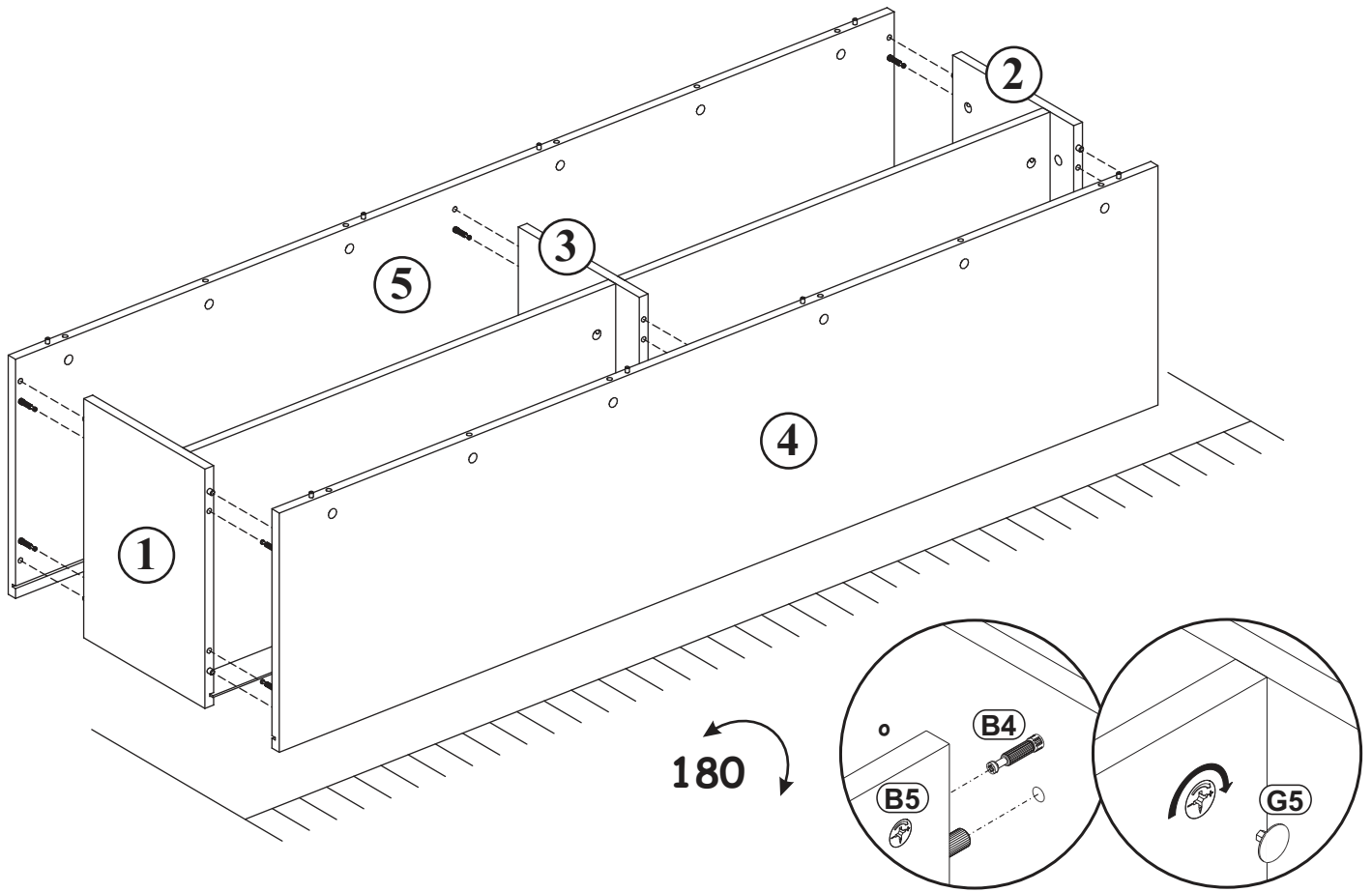

6

S1

x10

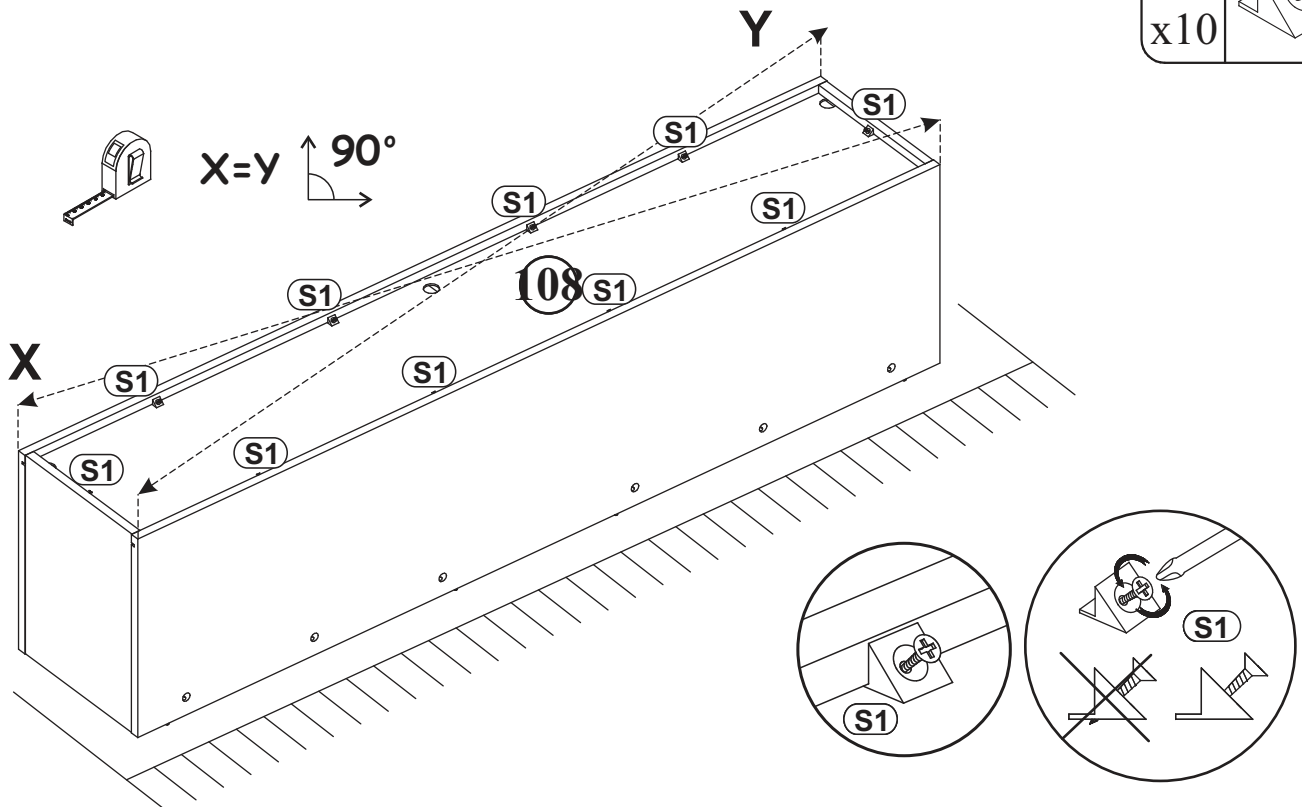
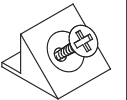

7

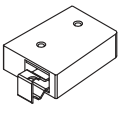
D6		ZR1	
x6	USØ3,5x30	x3	

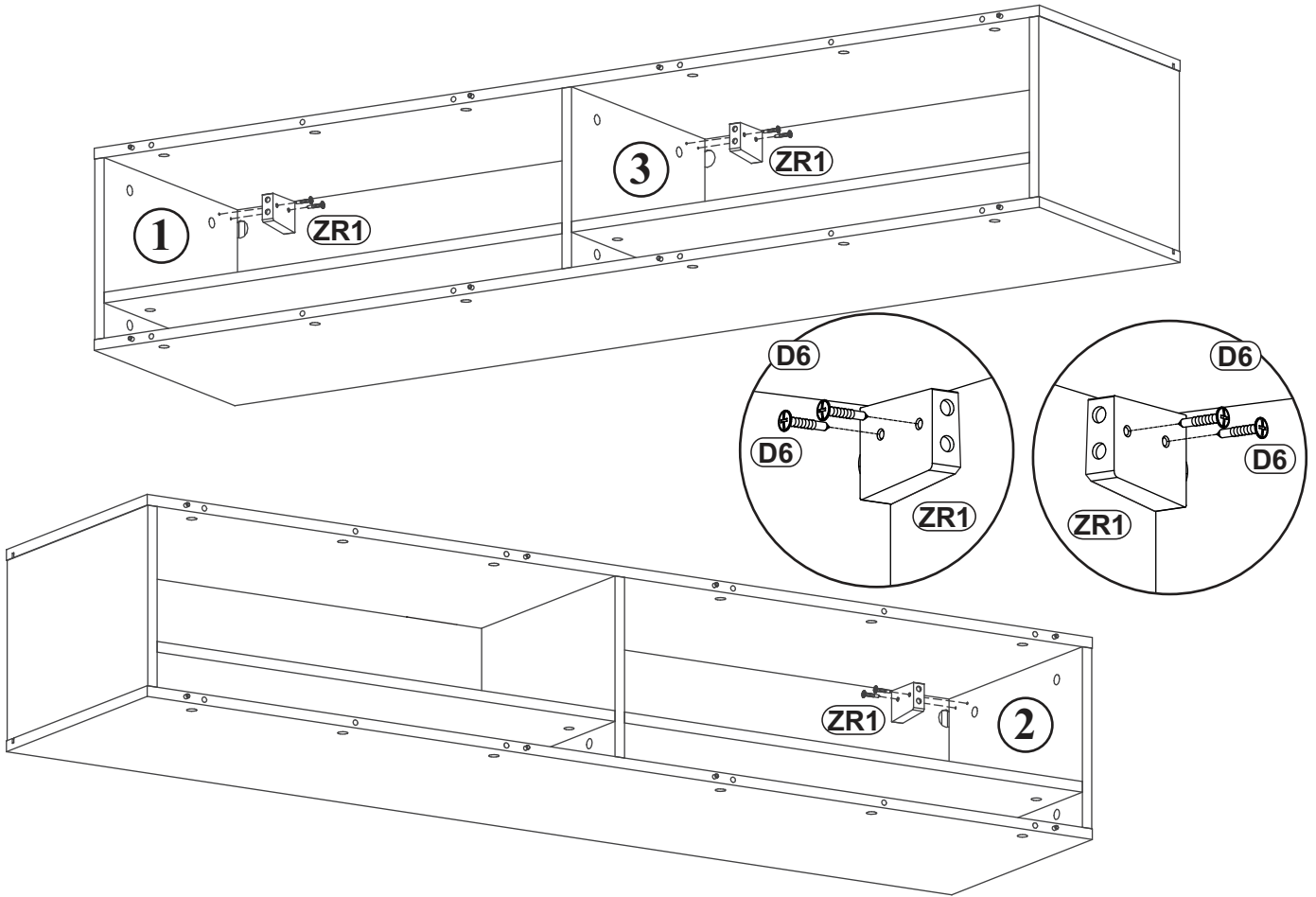

8

G5	
x12	

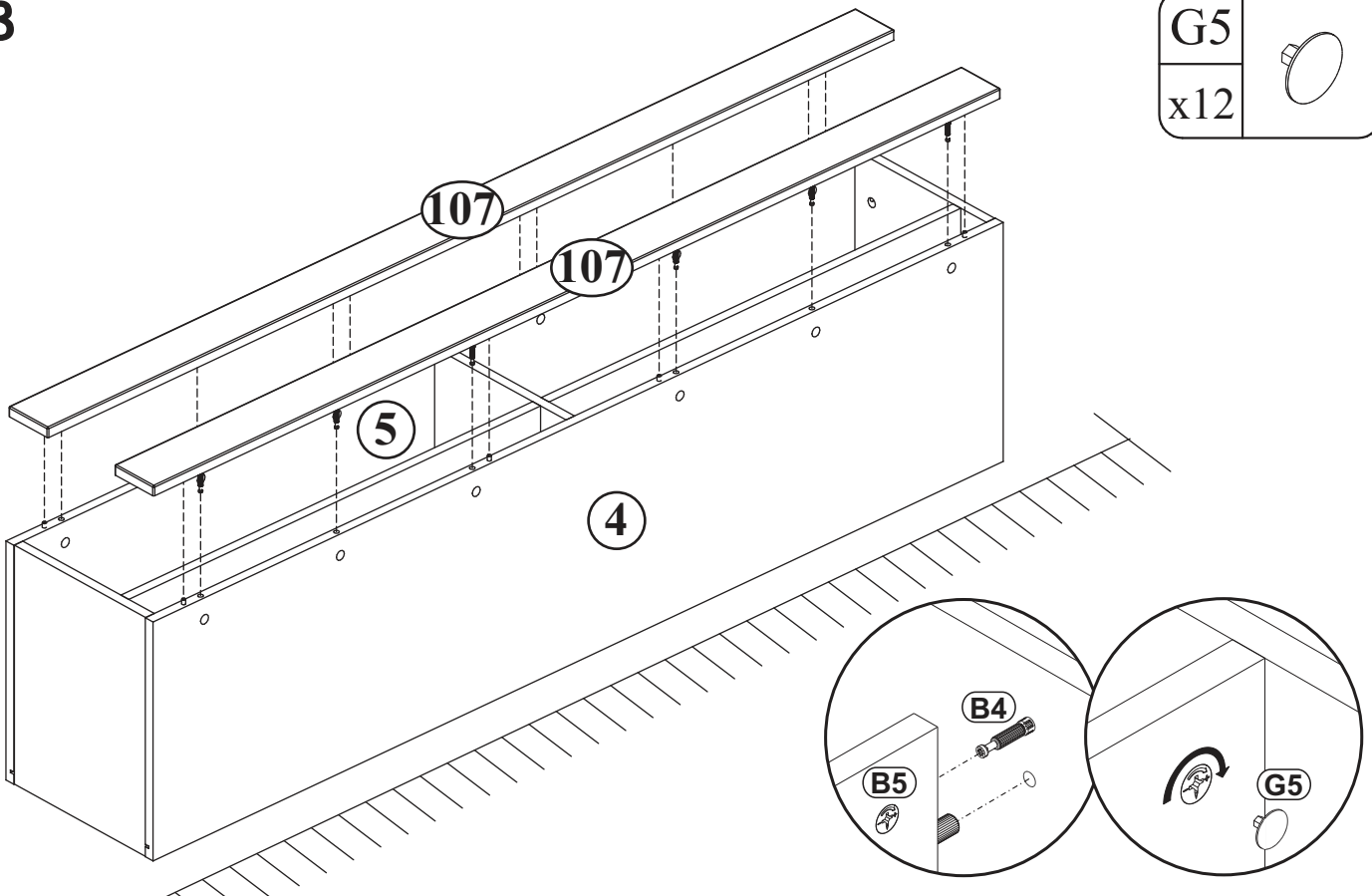

FLY 28--FY 34-C

9

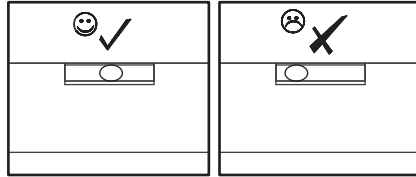

KR5
SFXP
x4

Ø 25/64"/1 31/32"
x2 23/64"
Ø10/50x60

SZ9
x1

L=61 37/64"
L=1564mm

LZ3
x1

