

# FLY 28 -- FY 21-C

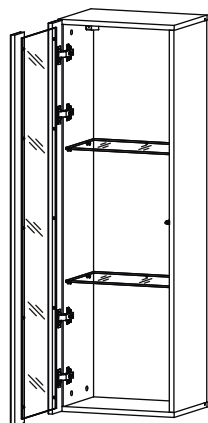

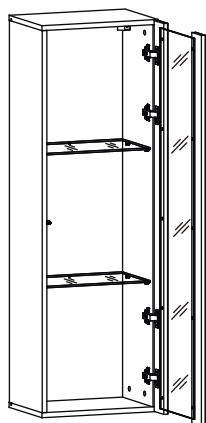

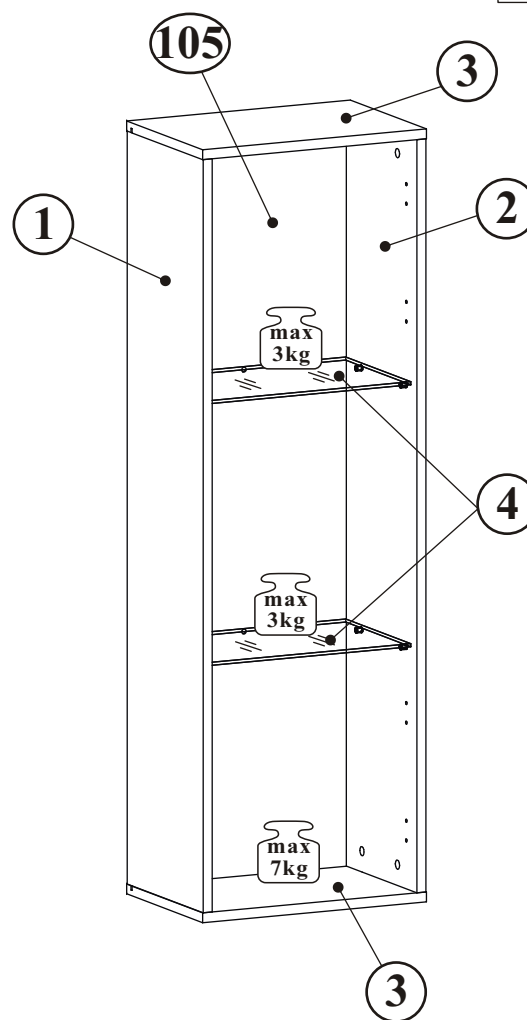

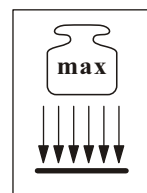
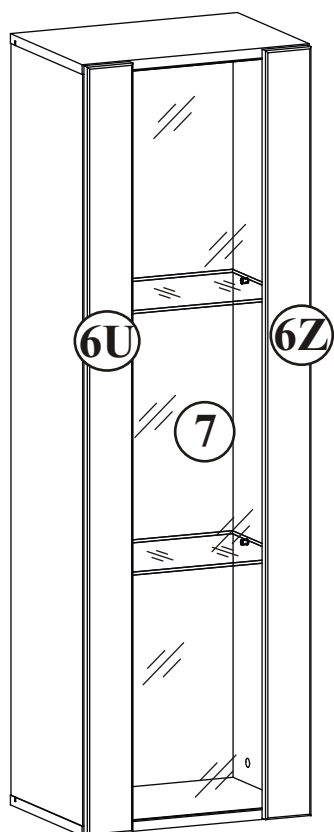
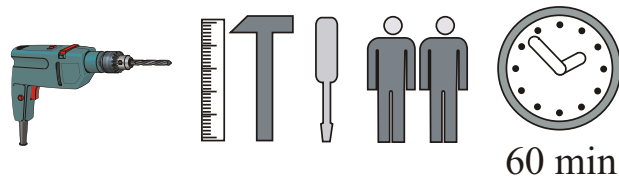



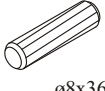
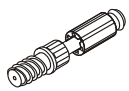

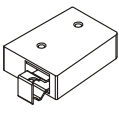

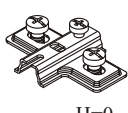
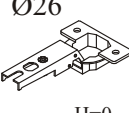
NO	Dim.		Col.-No	Qty
1	1228	274	1	1
2	1228	274	1	1
3	400	274	1	2
4	364	234	1	2
105	1240	378	1	1
6Z	80	1256	1	1
6U	80	1256	1	1
7	1224	283	1	1

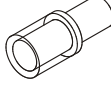

60 min

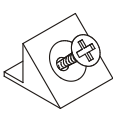
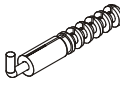
FLY 28--FY 21-C

A1 x8  ø8x36	B4 x8 	B5 x8  ø15x12	G5 x8 	ZR1 x2 	D6 x4  USØ3,5x30
E2 x4  H=0	E1 x4  Ø26 H=0	D10 x10  USØ3,5x13	AM x1 	G20 x8 	Z2 x8  Ø5
P2 x10 	UP13 x10  UPØ3x16	S1 x10 	KR2 x2 	G2 x1 	

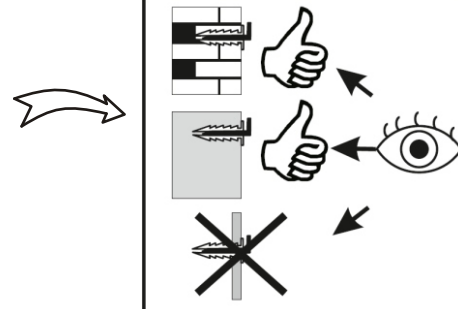
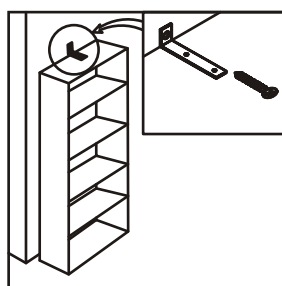
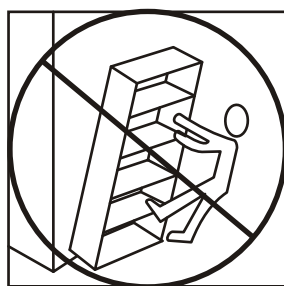
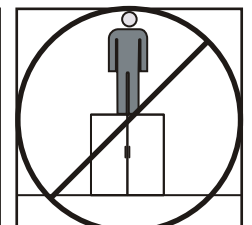
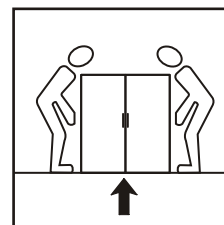
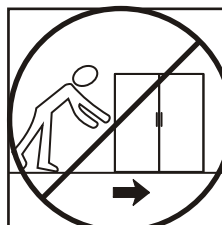
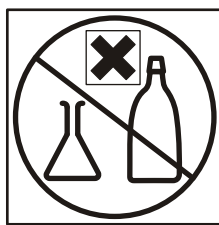
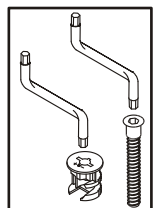
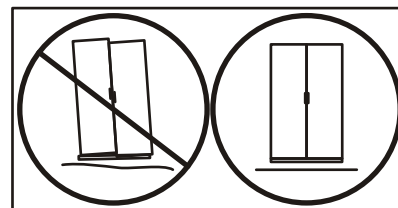
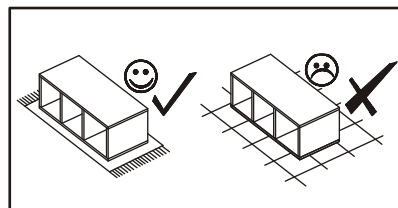
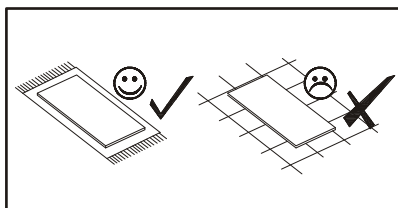
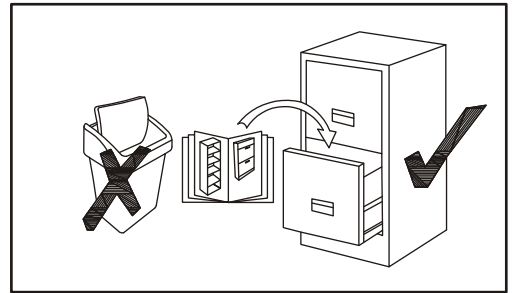
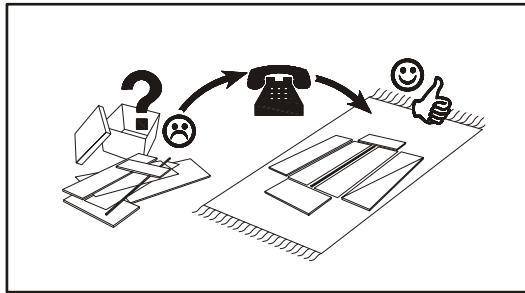
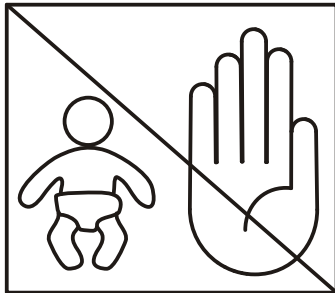
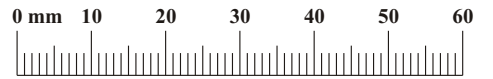

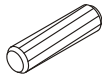
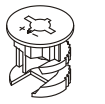
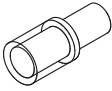
A1		B5		G20	
x8	ø8x36	x8	ø15x12	x8	

1

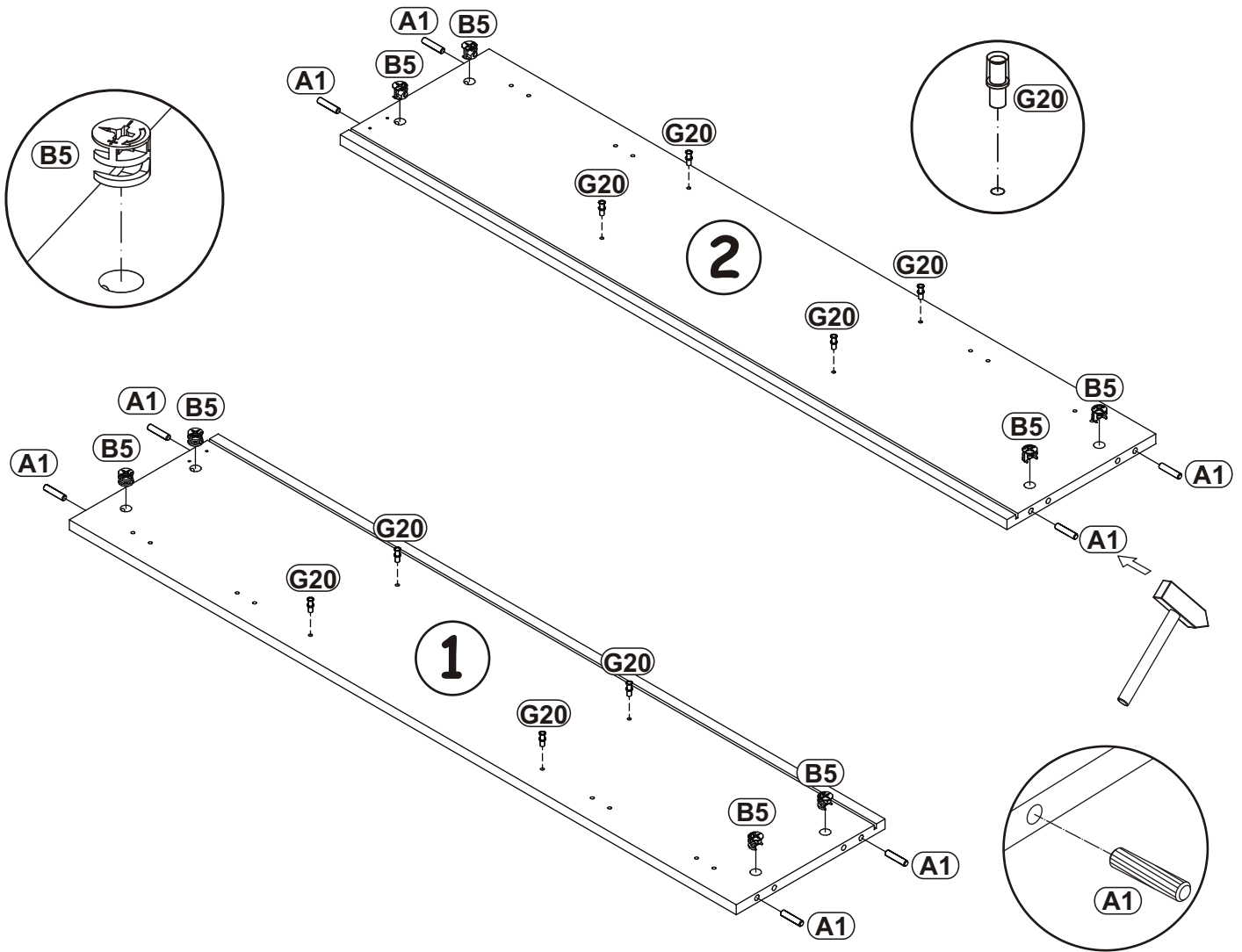

2

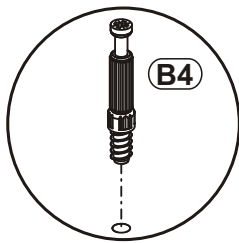

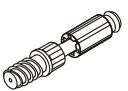

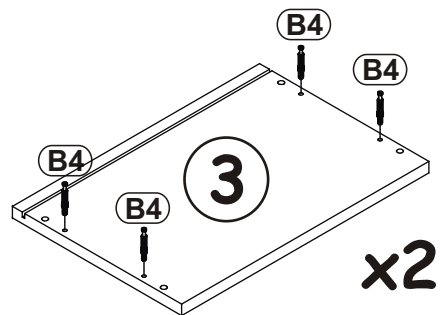
B4	
x8	

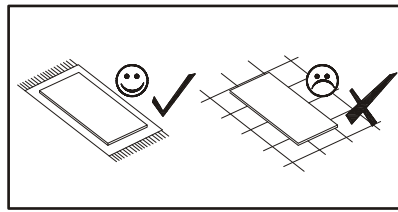

FLY 28--FY 21-C

3

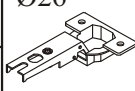
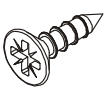

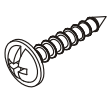

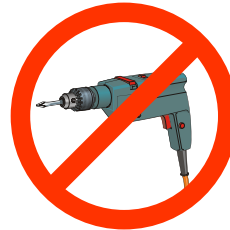
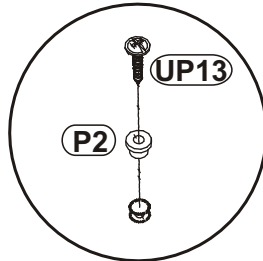
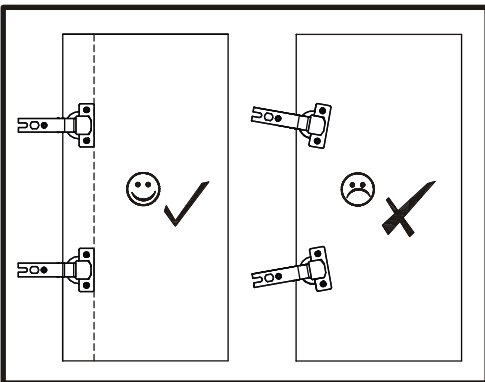
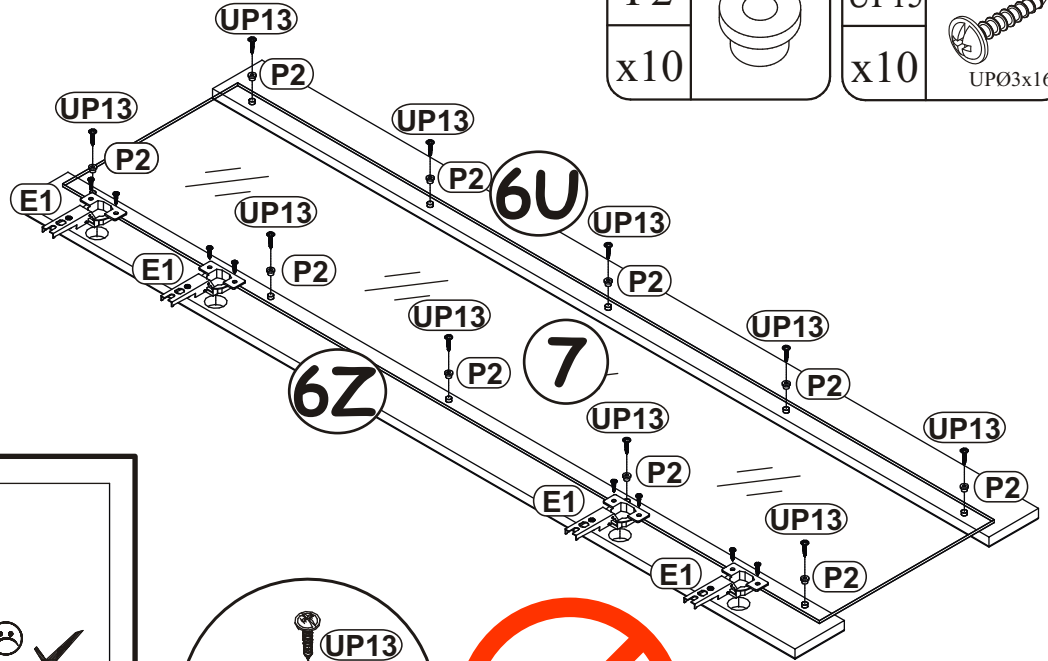
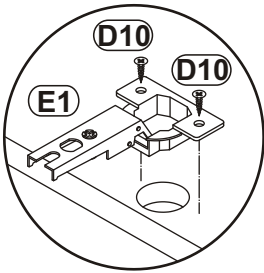
E1	Ø26	D10	
x4	 H=0	x8	 USØ3,5x13
P2		UP13	
x10		x10	 UPØ3x16

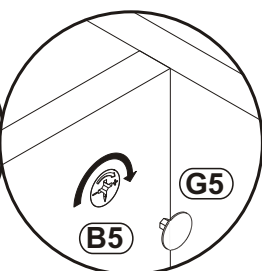
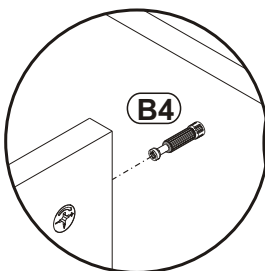
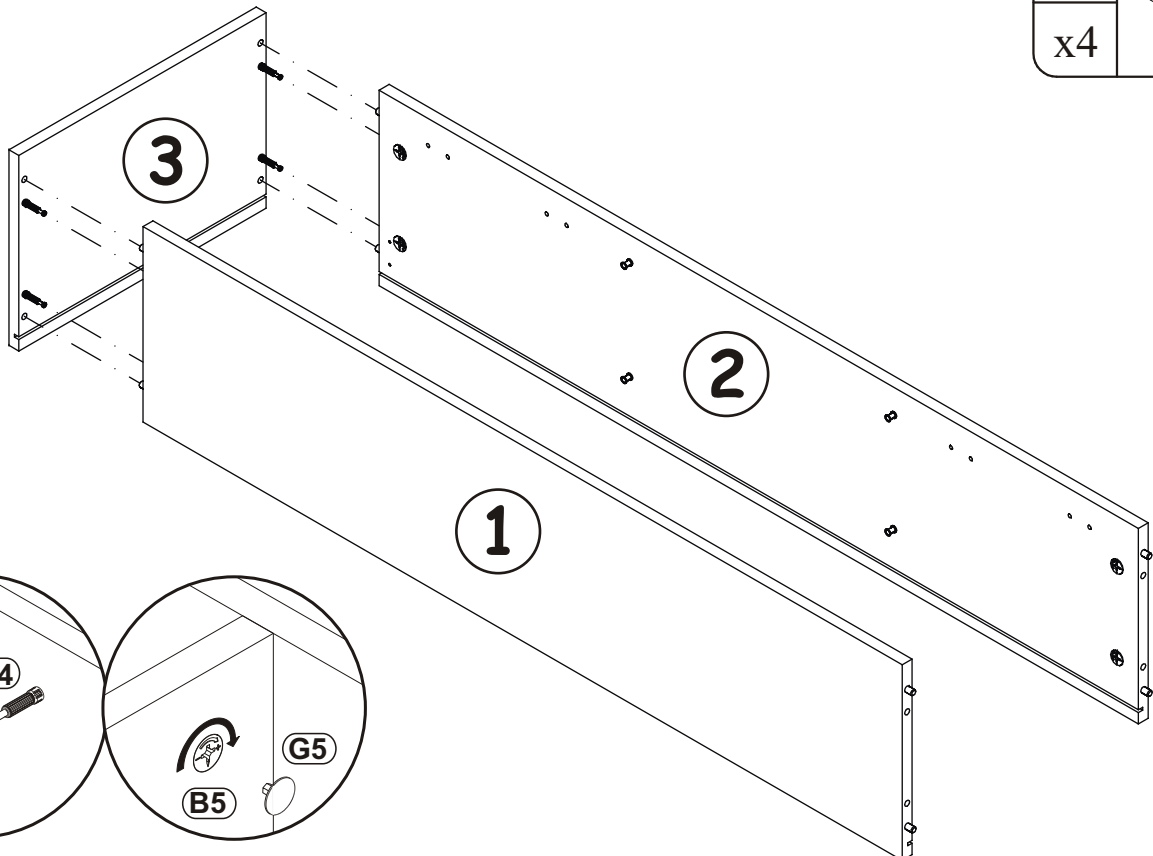

4

G5	
x4	



G5	
x4	

5

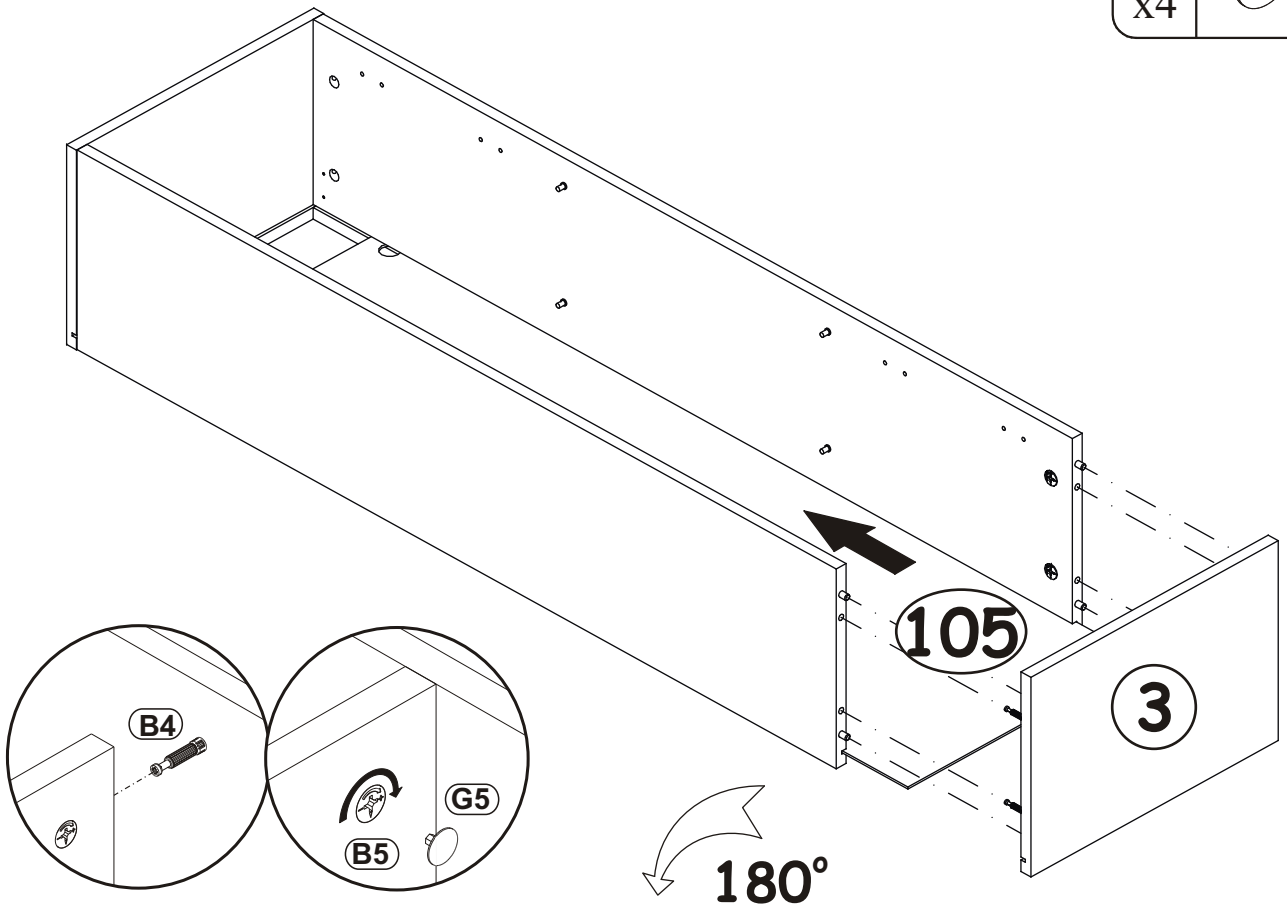

6

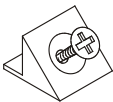

S1	
x10	

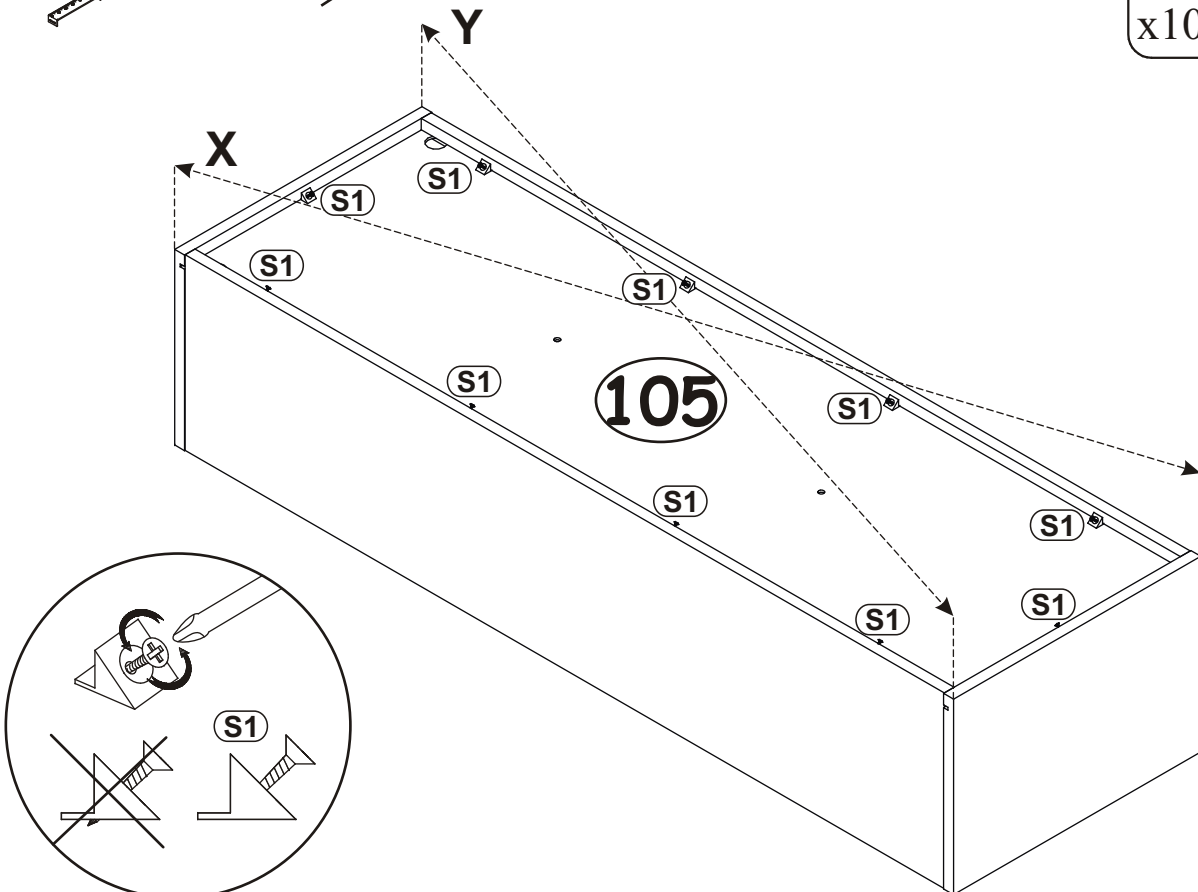

FLY 28--FY 21-C

7

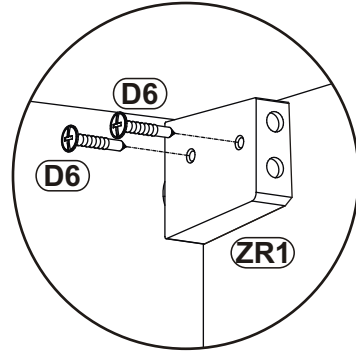
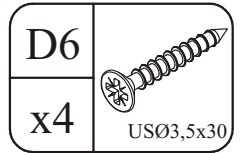
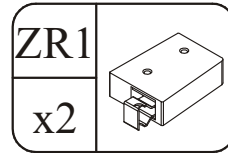
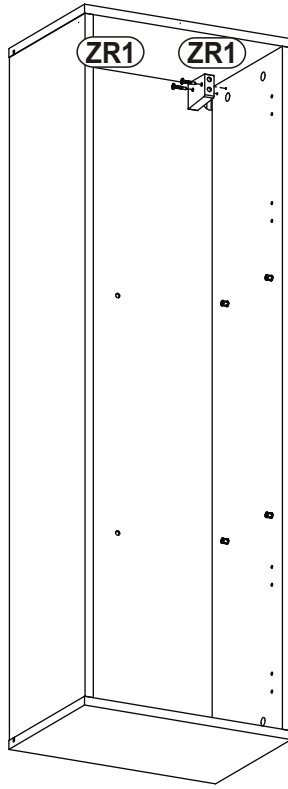
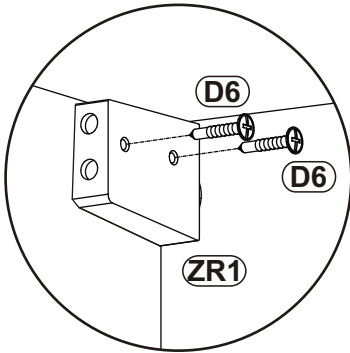

8

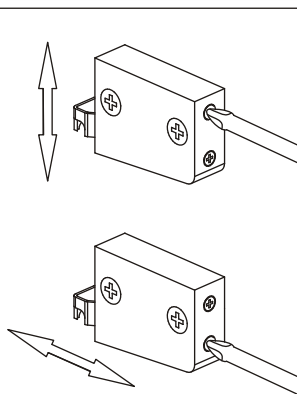
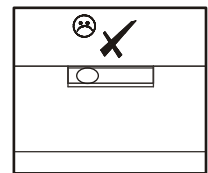
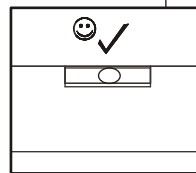
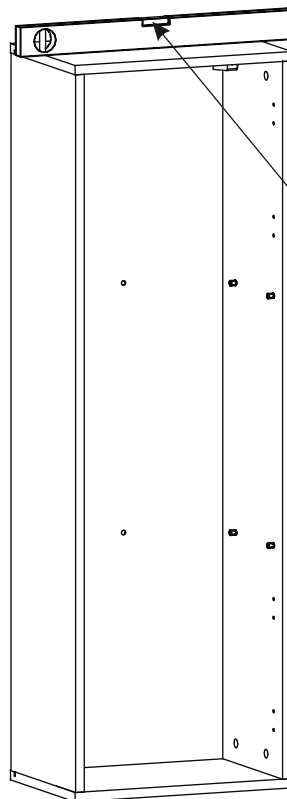
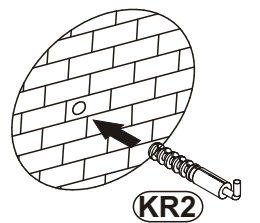
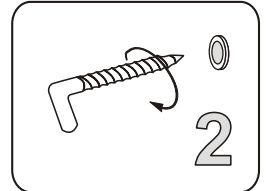
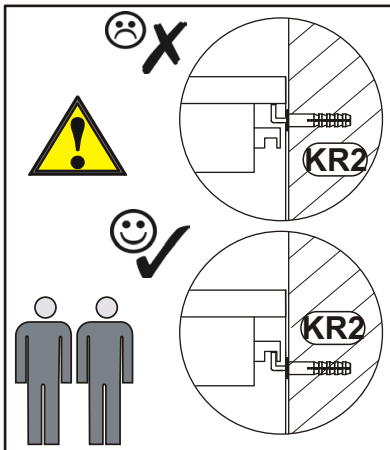
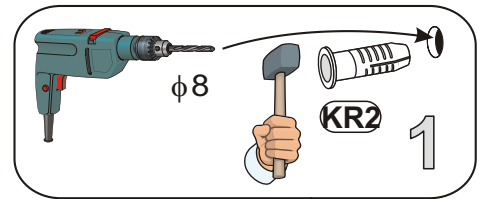
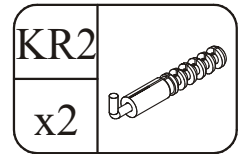
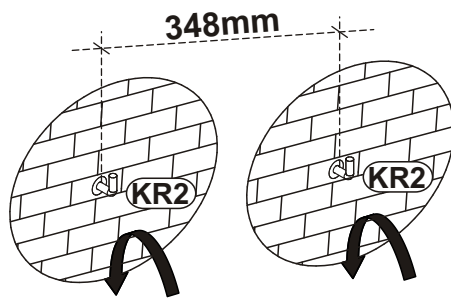
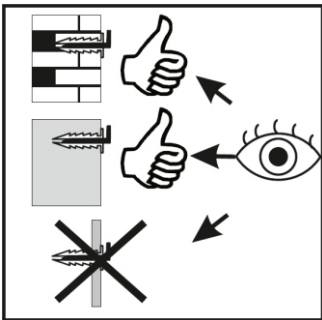

**9-10**

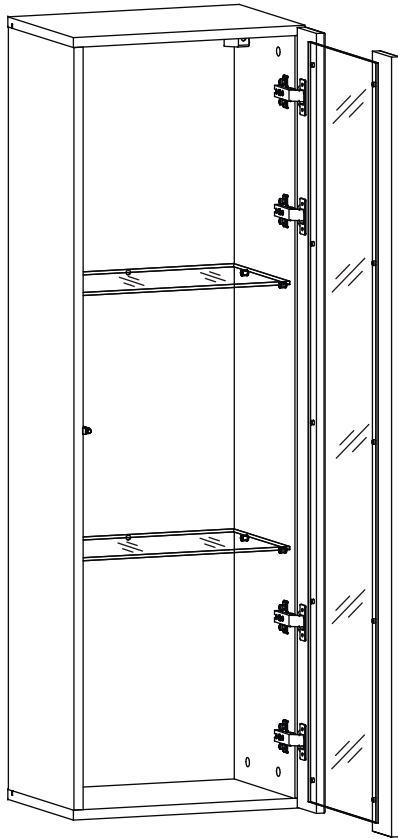

**11-12**

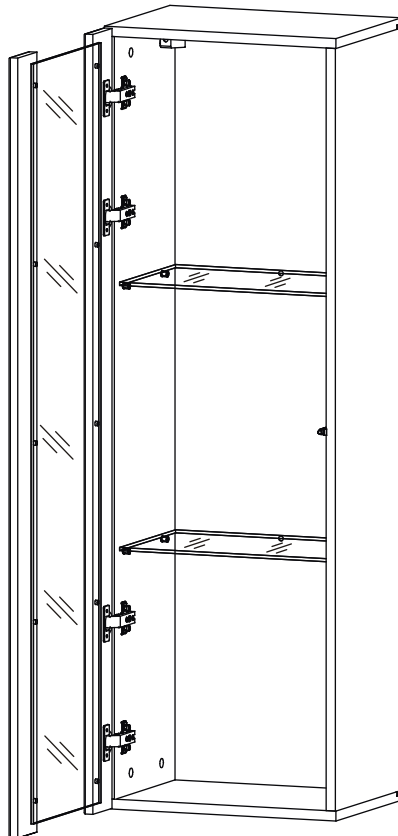

9

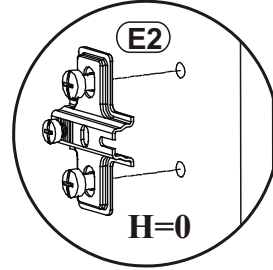
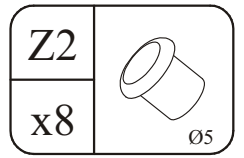
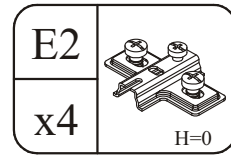
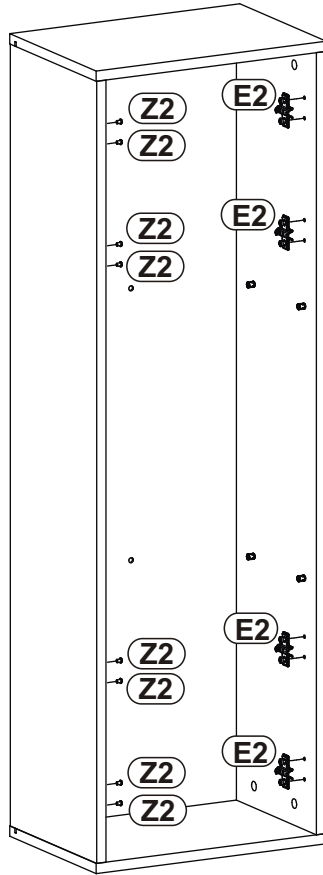
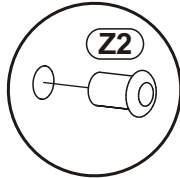

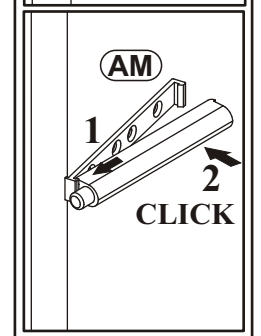
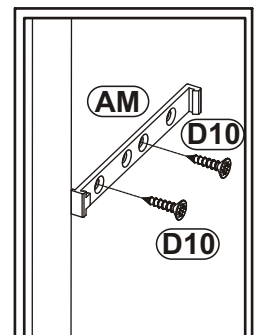
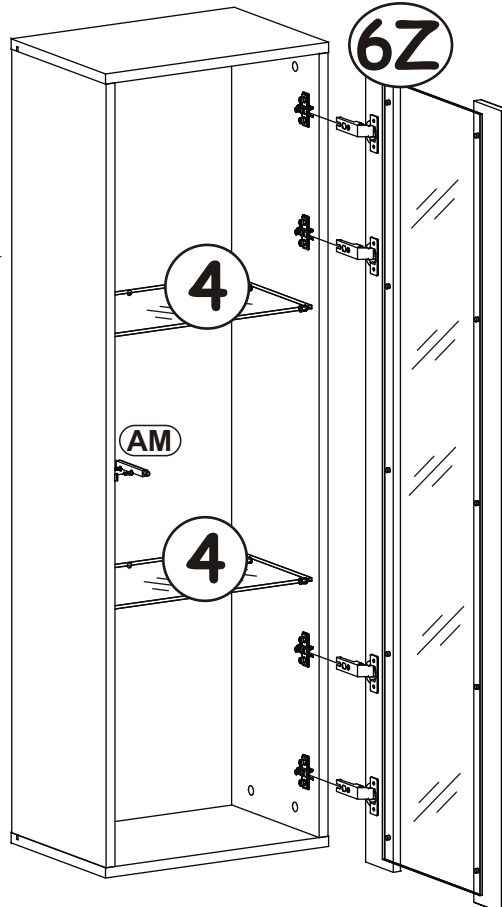
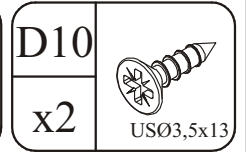
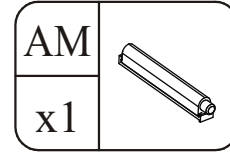
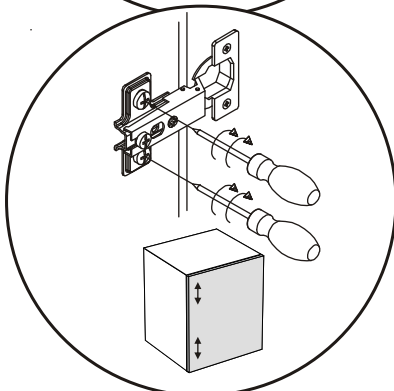
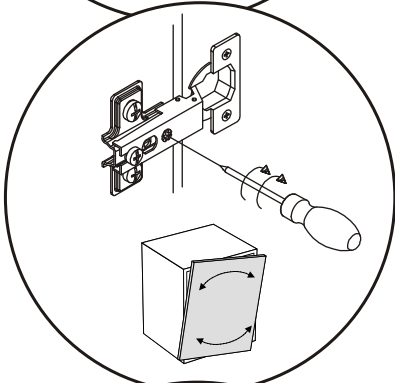
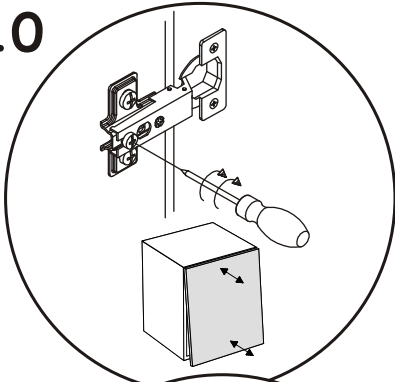

10



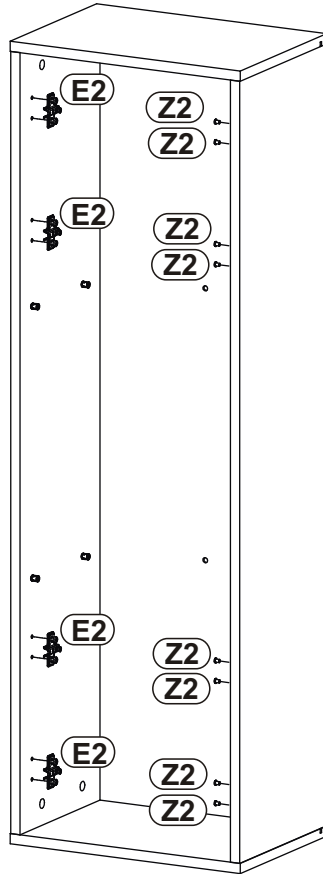
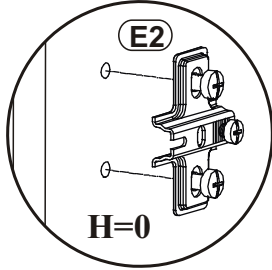

11

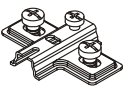

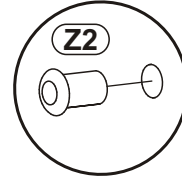

E2		Z2	
x4	H=0	x8	Ø5

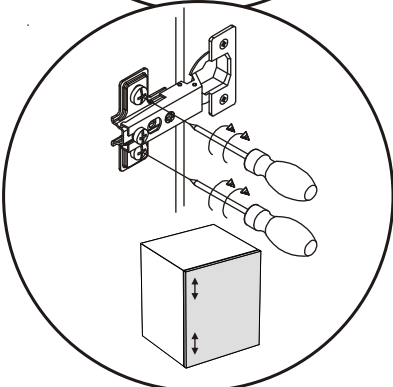
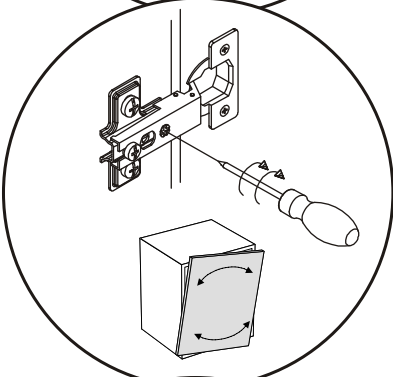
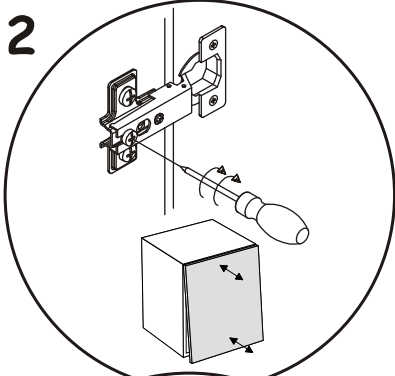

12

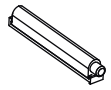

AM		D10	
x1		x2	USØ3,5x13

