

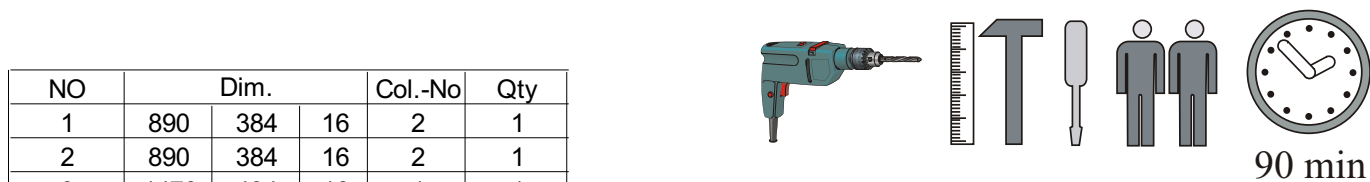

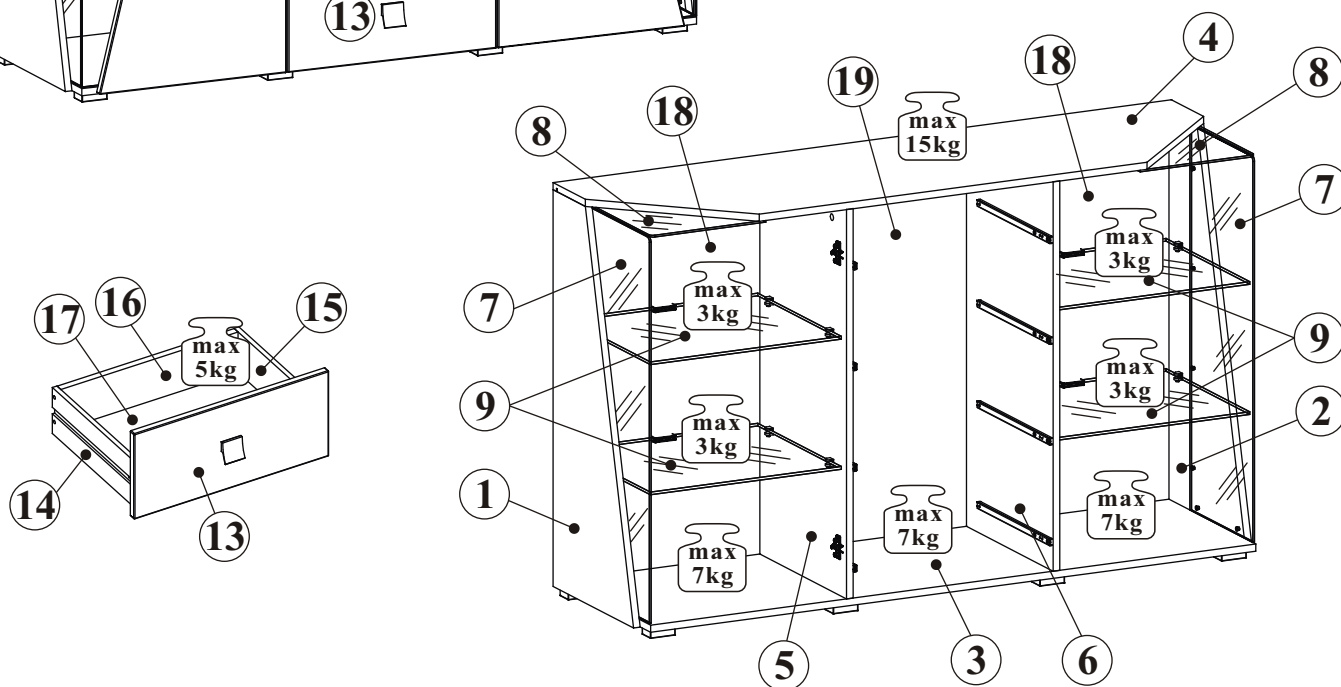

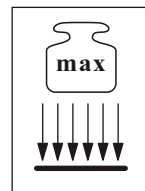

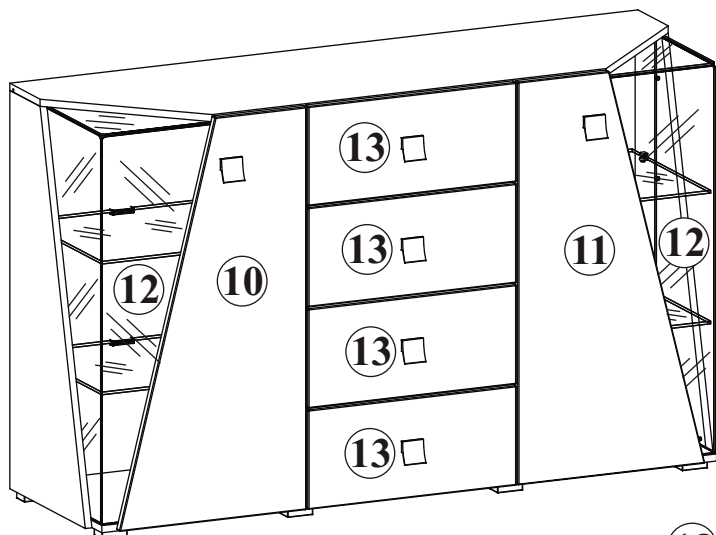

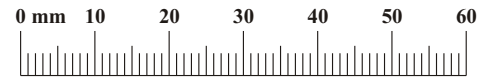
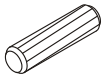
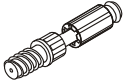

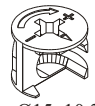

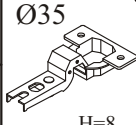
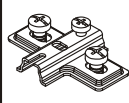

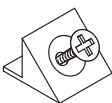
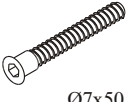

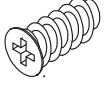

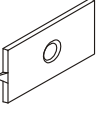

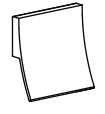
EDGE 29--EE SB

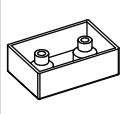

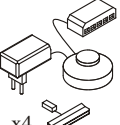
NO	Dim.			Col.-No	Qty
1	890	384	16	2	1
2	890	384	16	2	1
3	1470	434	16	1	1
4	1502	434	16	1	1
5	874	414	16	3	1
6	874	414	16	3	1
7	865	300	4	2	2
8	279	305	4	2	2
9	464	399	6	2	4
10	446	900	16	3	1
11	446	900	16	1	1
12	865	280	4	2	2
13	498	222	16	3	4
14	350	120	12	1	4
15	350	120	12	1	4
16	453	106	16	1	4
17	355	463	3	1	4
18	885	489	3	3	2
19	885	400	3	3	1

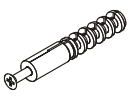
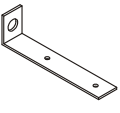

A1 x24  ø8x36	B4 x18 	B5 x10  ø15x12	G5 x10 	B7 x8  Ø15x10,3	G8 x8  Ø20
E23 x4  Ø35 H=8	E2 x4  H=0	D10 x12  USØ3,5x13	S1 x22 	B11 x20  Ø7x50	G4 x20 
H6 x4  L-342mm	D21 x16  ESØ6x9,5	D18 x8  M4x9	G16 x12 	UP13 x60  UPØ3x16	P2 x32 
U19 x6 	DS4 x4  WSM4x22	D26 x8  M4x22	ST17 x8 	UP11 x16  UPØ4x20	LED x1 x4 
G31 x12 	D20 x12  ESØ6,3x9,5	KR1 x2 	L1 x2 	G2 x1 	

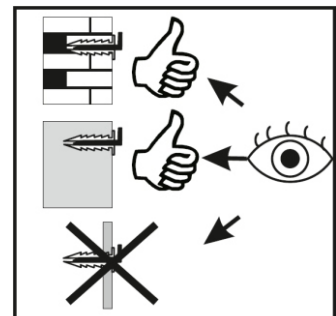
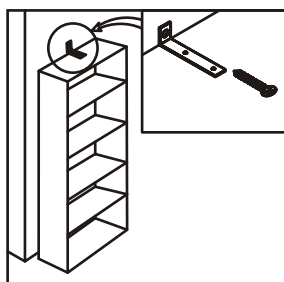
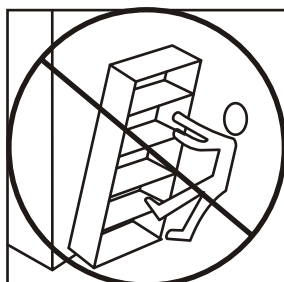
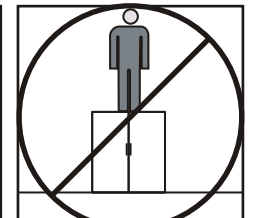
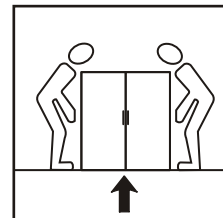
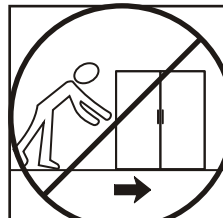
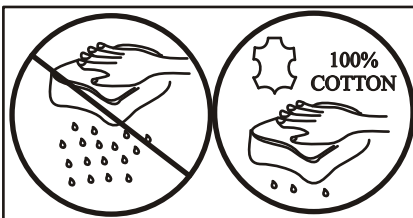
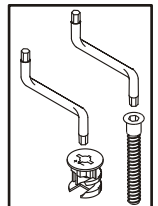
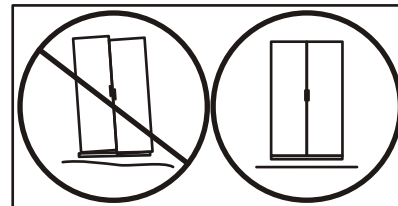
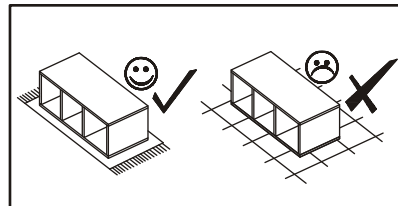
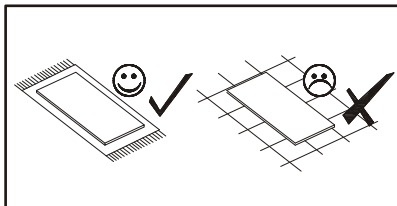
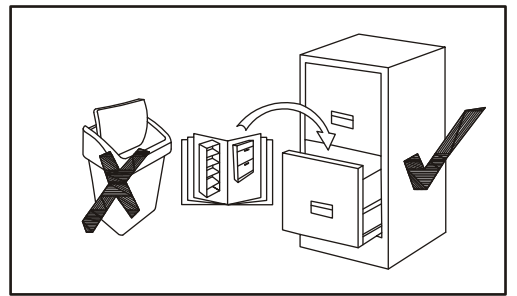
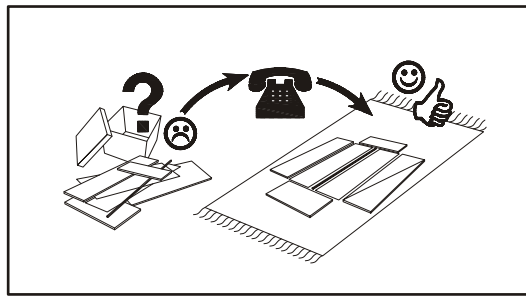
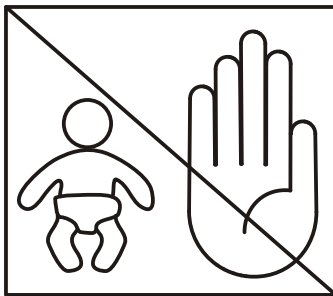



EDGE 29--EE SB

1

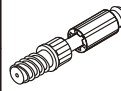
A1	
x4	ø8x36

B4	
x4	



B5	
x2	ø15x12

P2	
x12	

G31	
x4	

D20	
x4	ESØ6,3x9,5

UP13	
x12	UPØ3x16

10,3mm		B7
12mm		B5

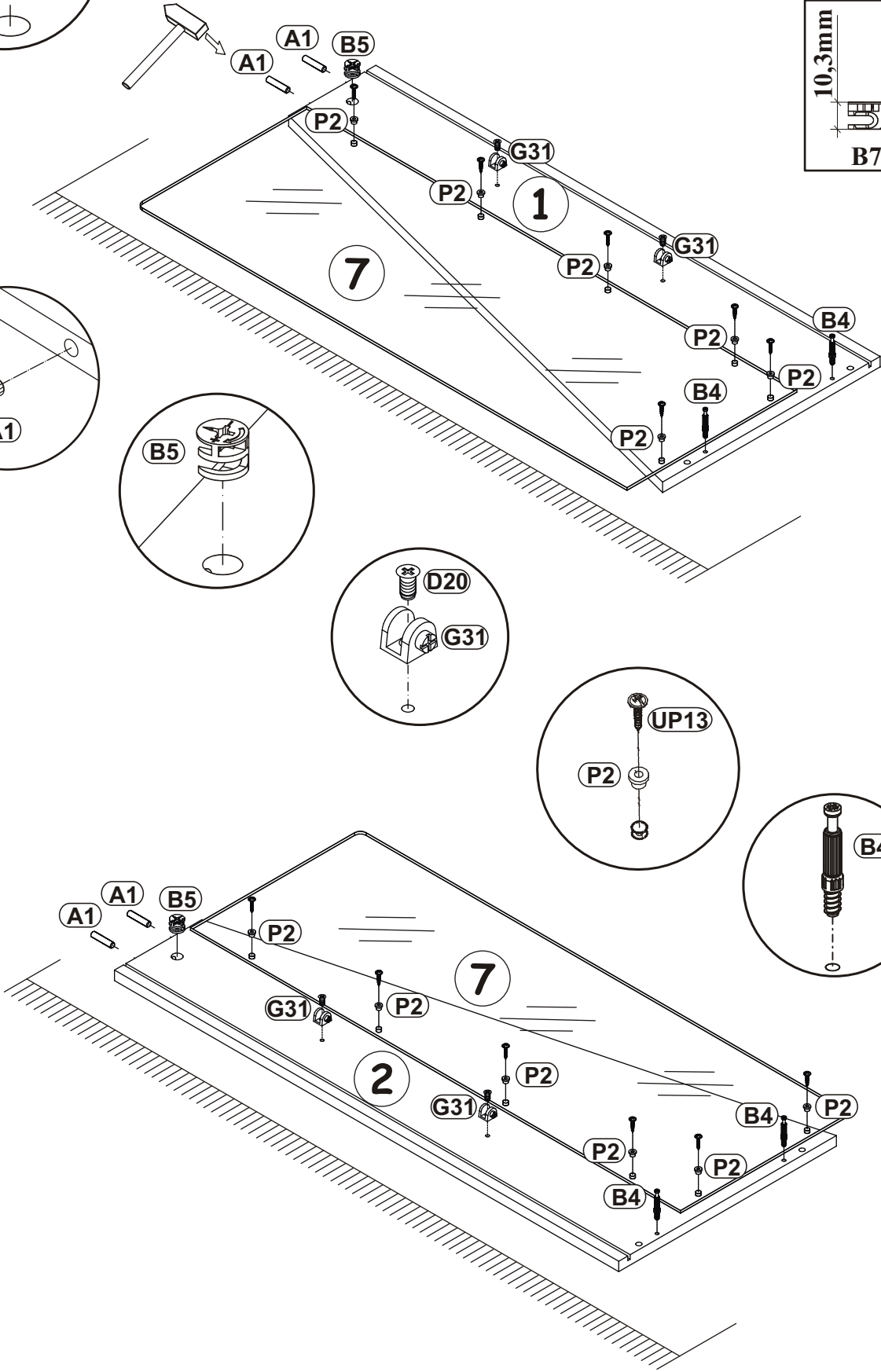
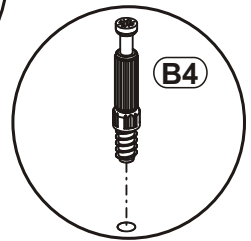
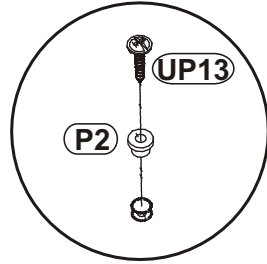
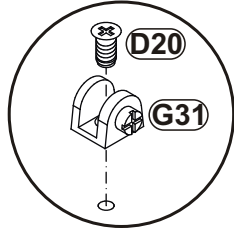
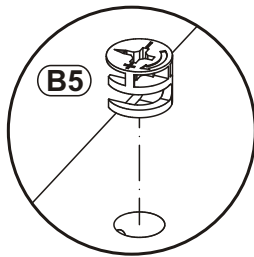
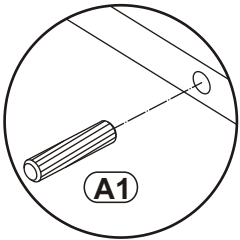
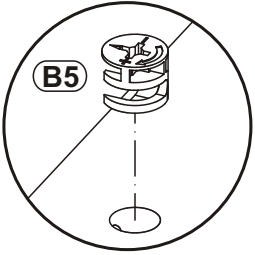

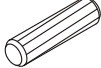

EDGE 29--EE SB

2

A1	
x4	ø8x36

B5	
x2	ø15x12

G31	
x4	

D20	
x4	ES06,3x9,5

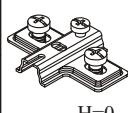
E2	
x2	H=0

H6	
x2	L-342mm

D21	
x8	ES06x9,5

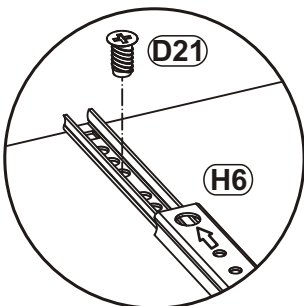
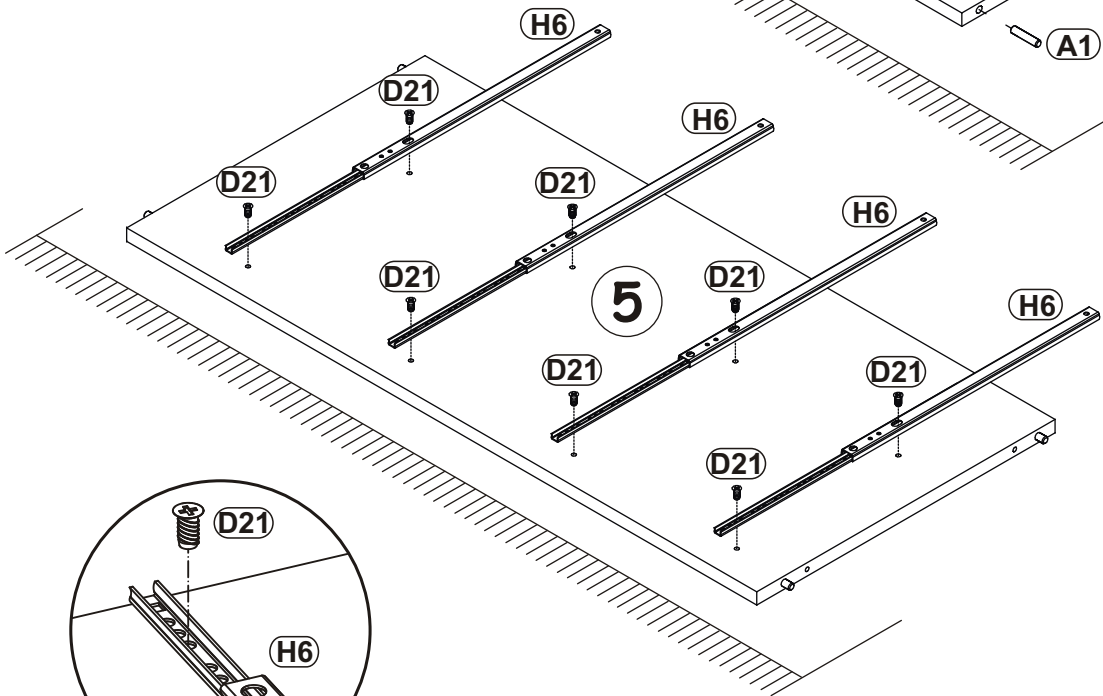
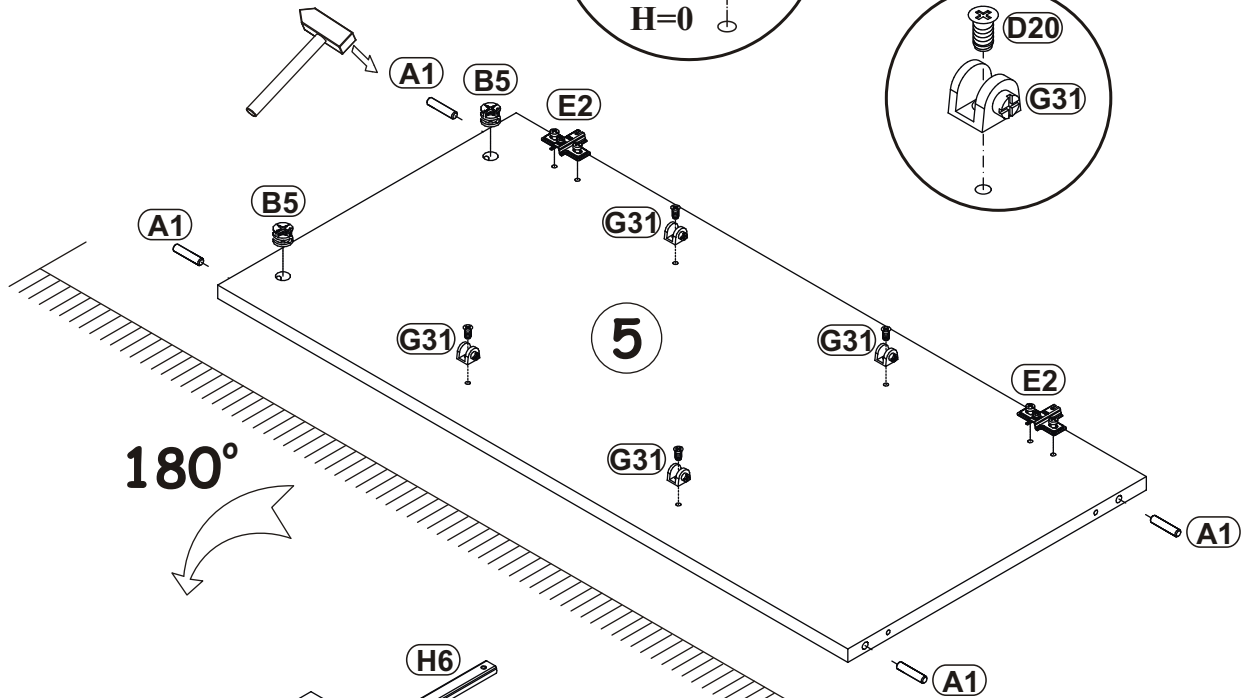
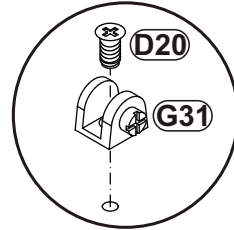
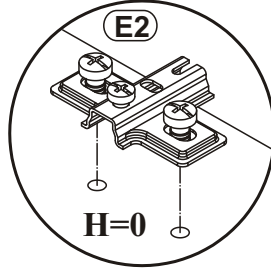
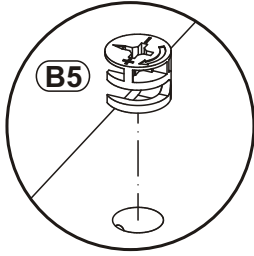
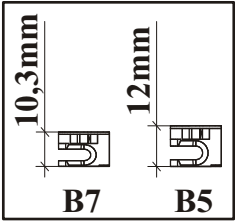

EDGE 29--EE SB

3

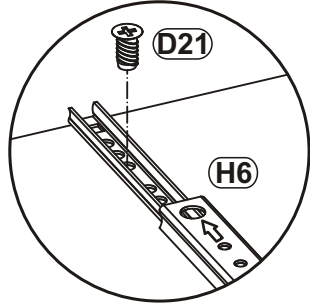
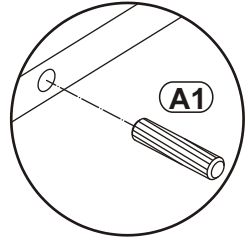
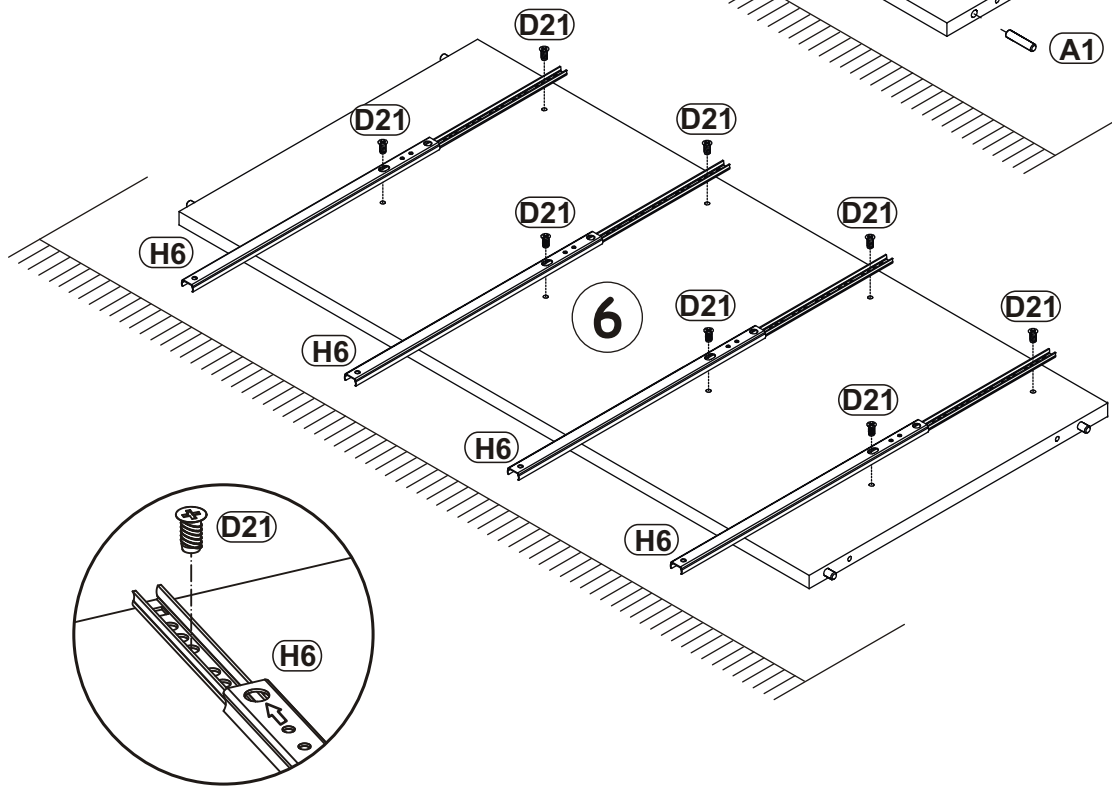
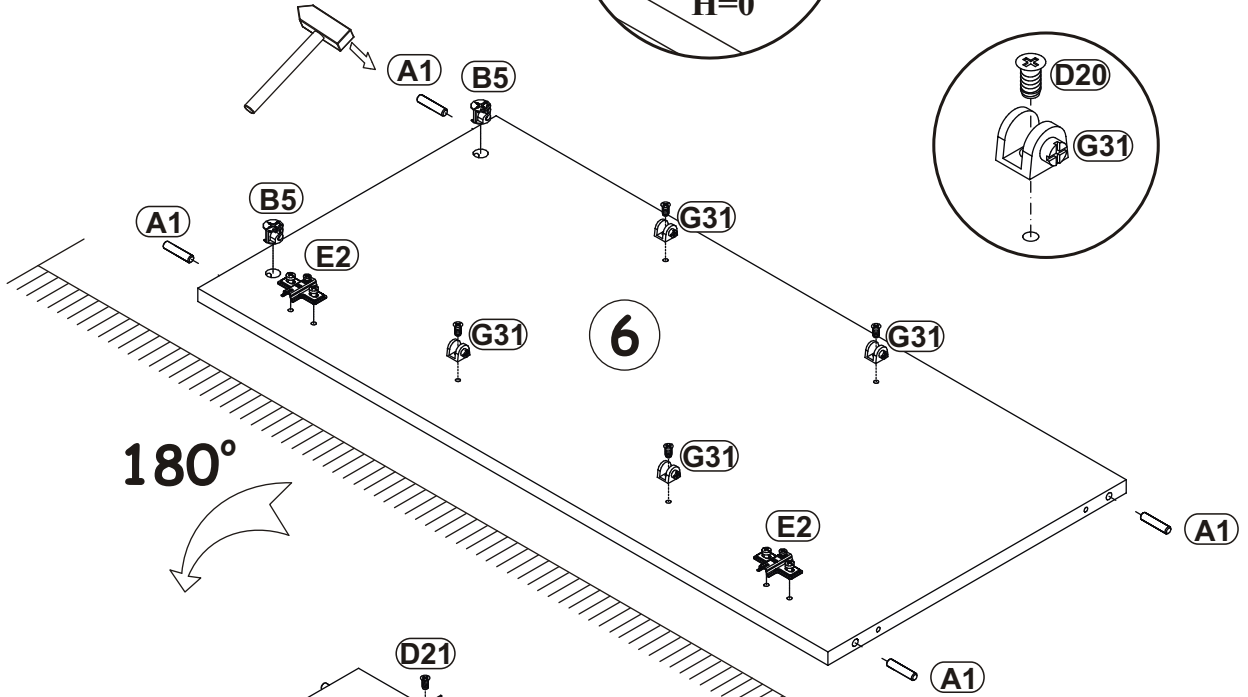
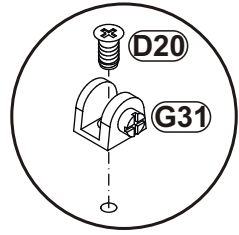
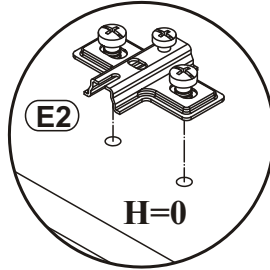
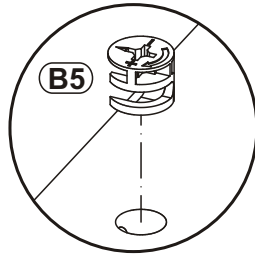
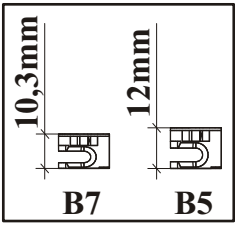
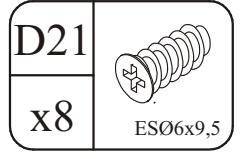
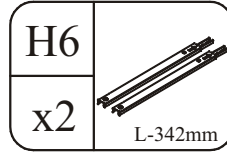
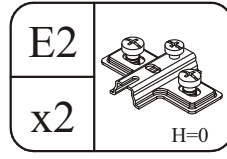
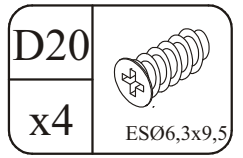
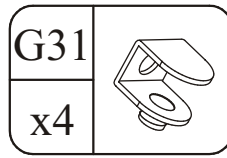
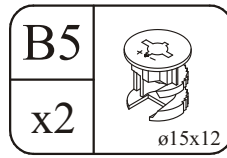
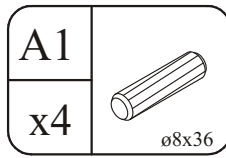

EDGE 29--EE SB

4

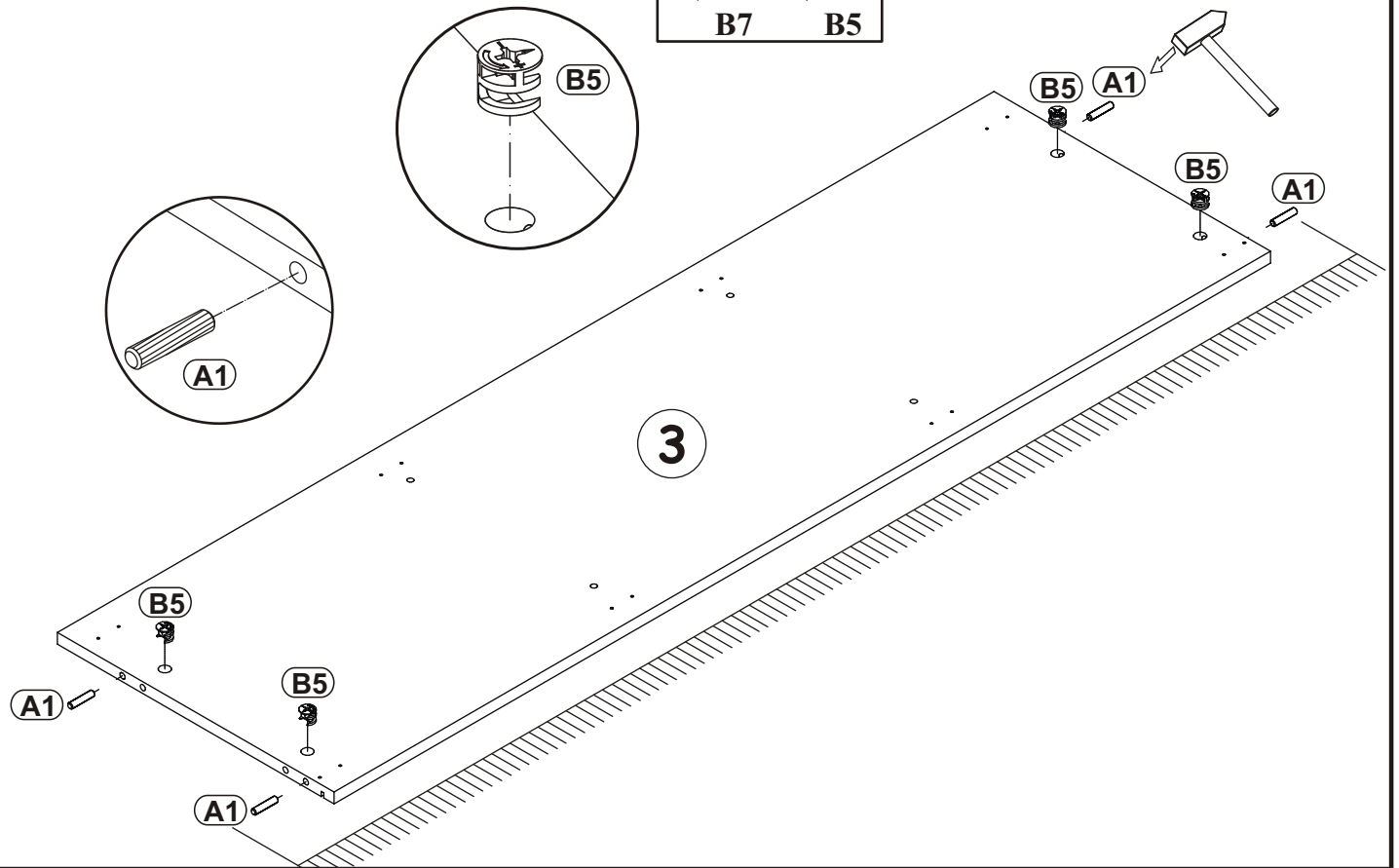
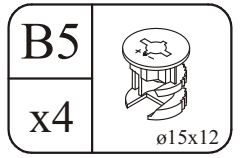
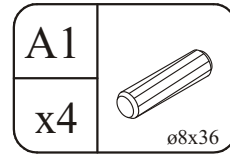
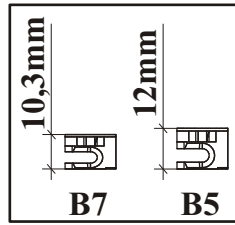

5

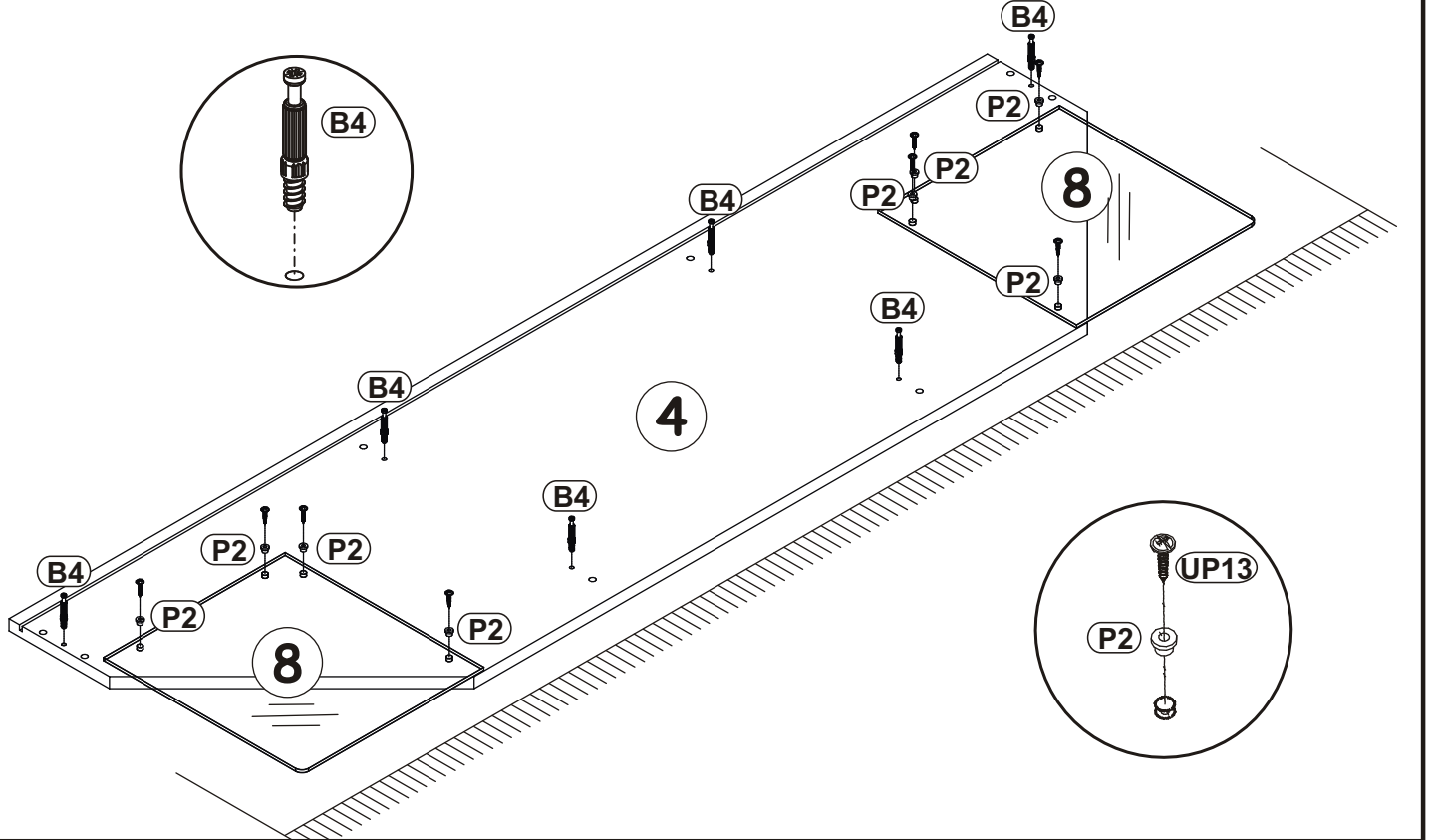
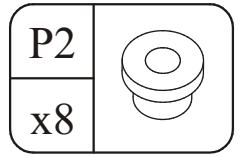
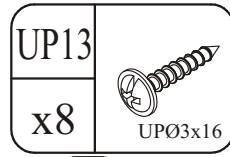
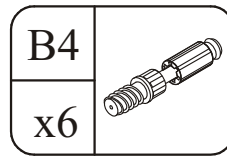

6

U19		DS4	
x2		x4	WSM4x22

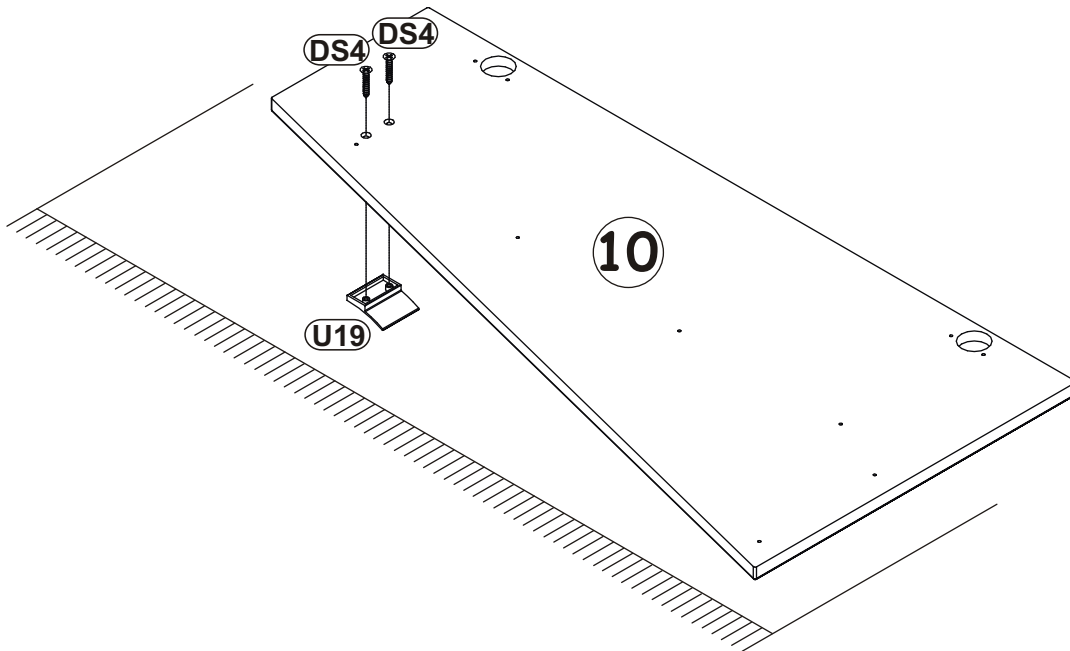
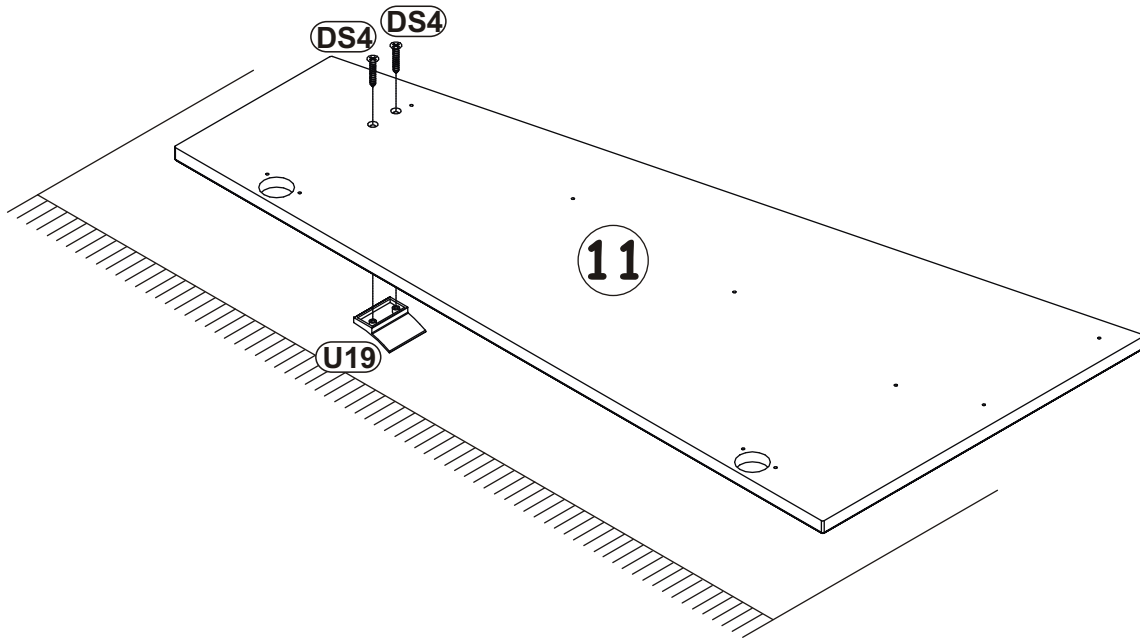

7

E23	Ø35
x4	H=8

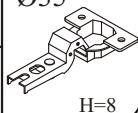

D10
x8



USØ3,5x13

P2
x12



UP13
x12



UPØ3x16

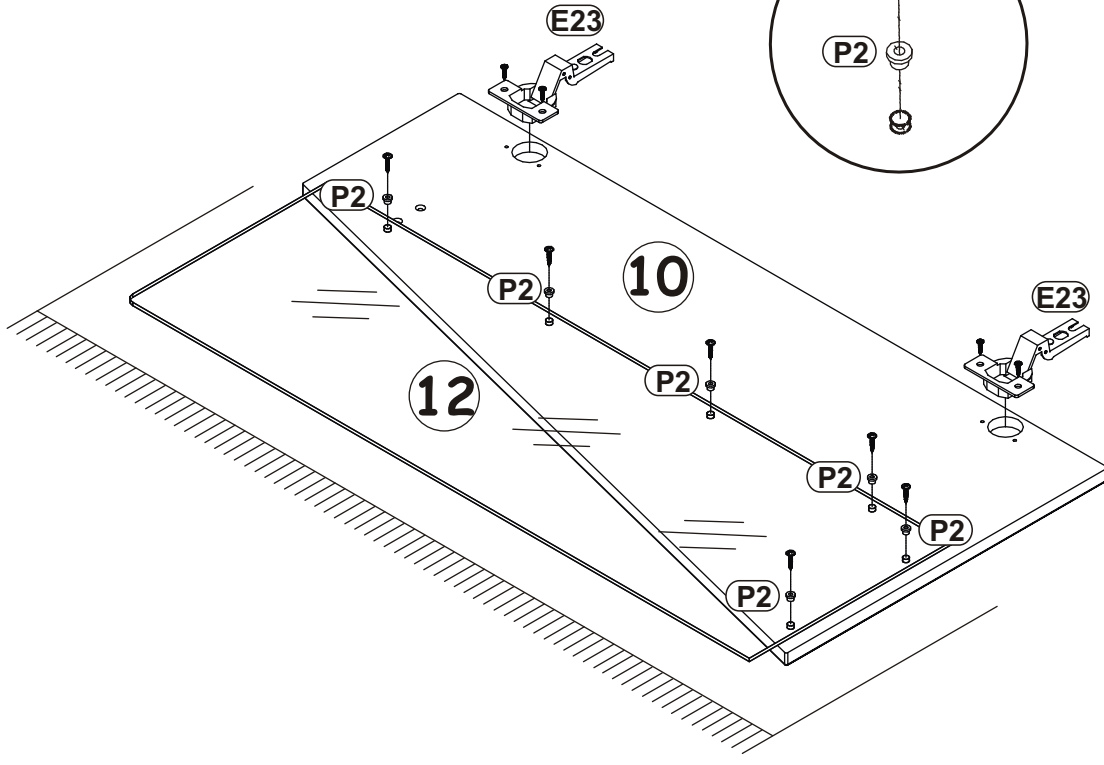
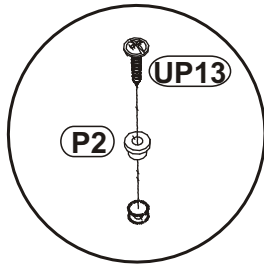
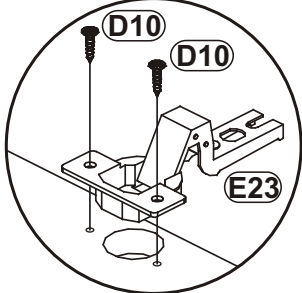
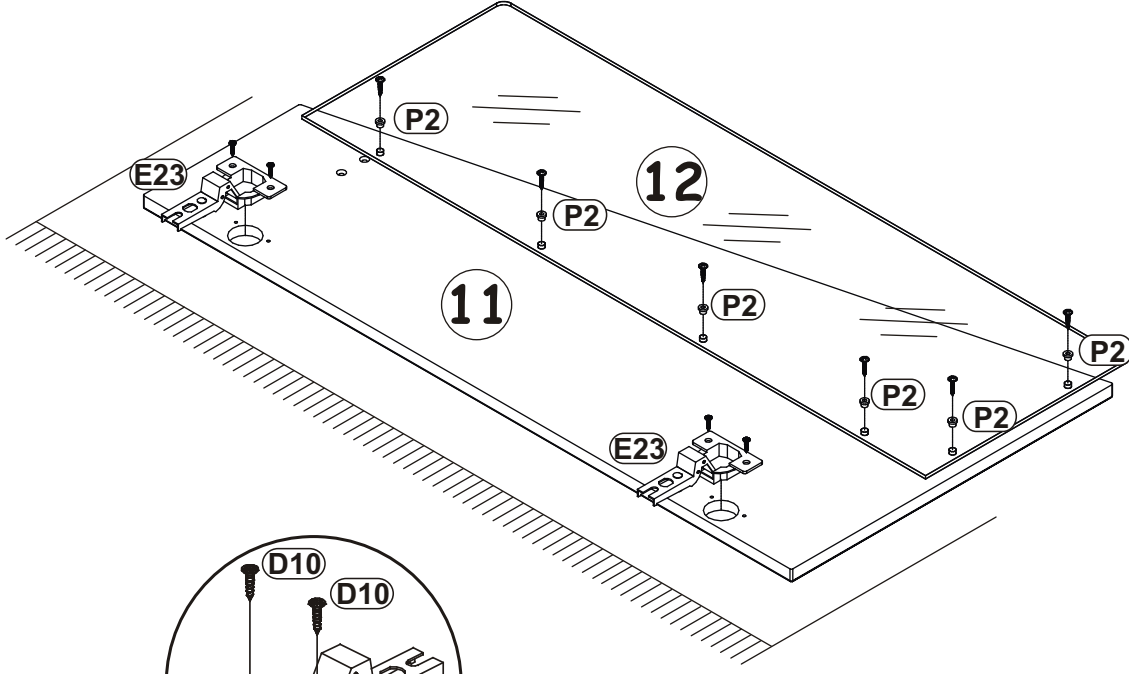

8

B4

x8

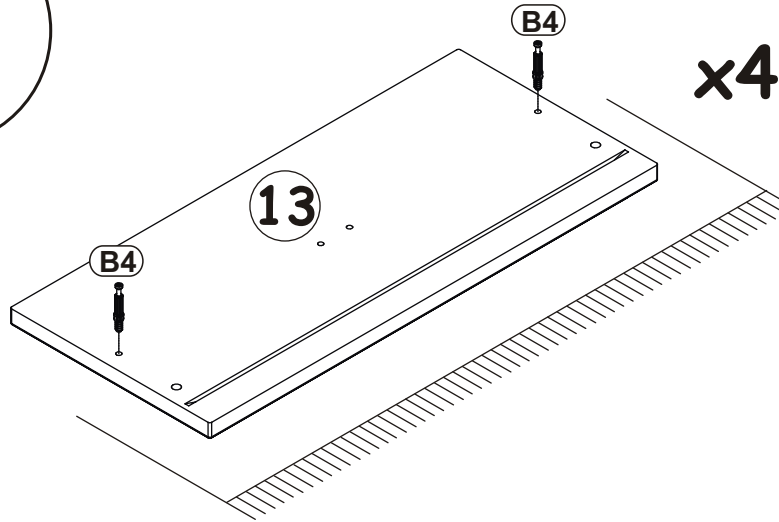
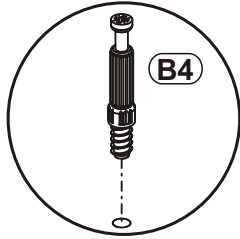
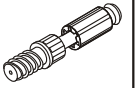

9

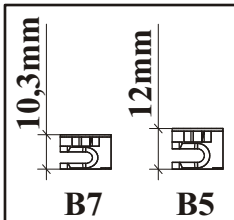

A1

x8

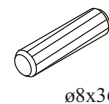

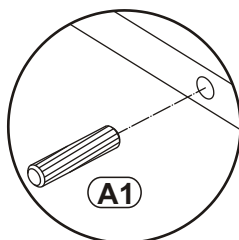
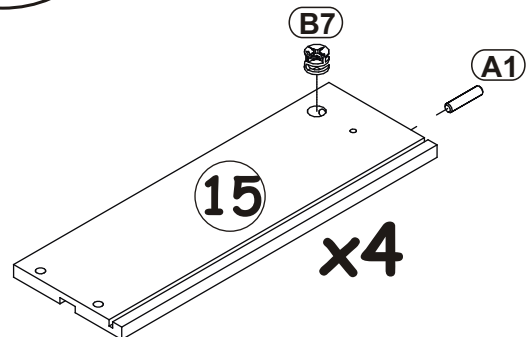
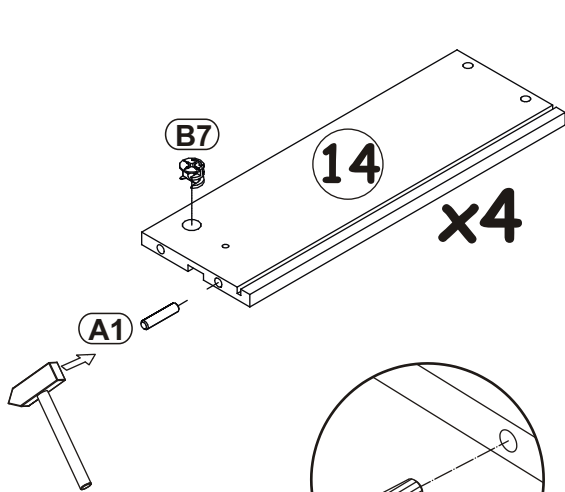
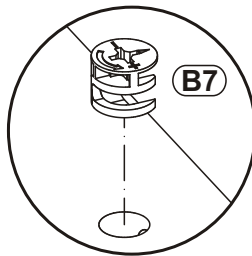

B7

x8

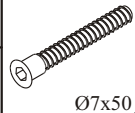

10

B11		G4	
x16	Ø7x50	x16	

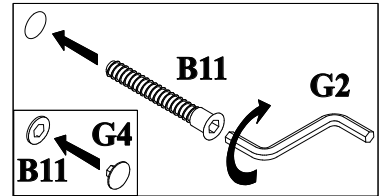
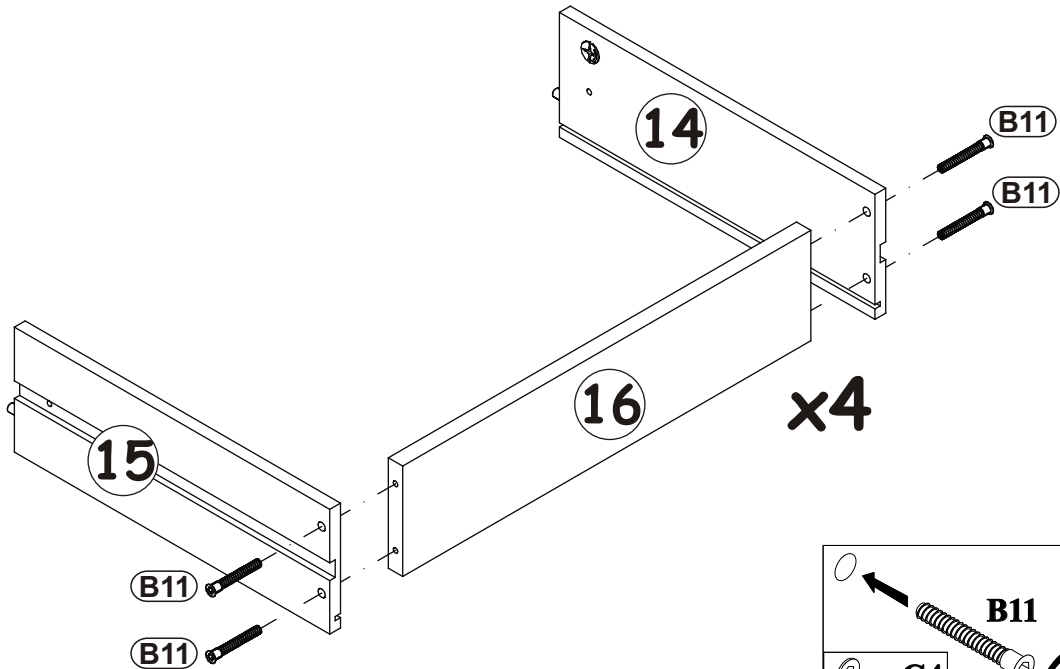

11

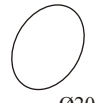
G8	
x8	Ø20

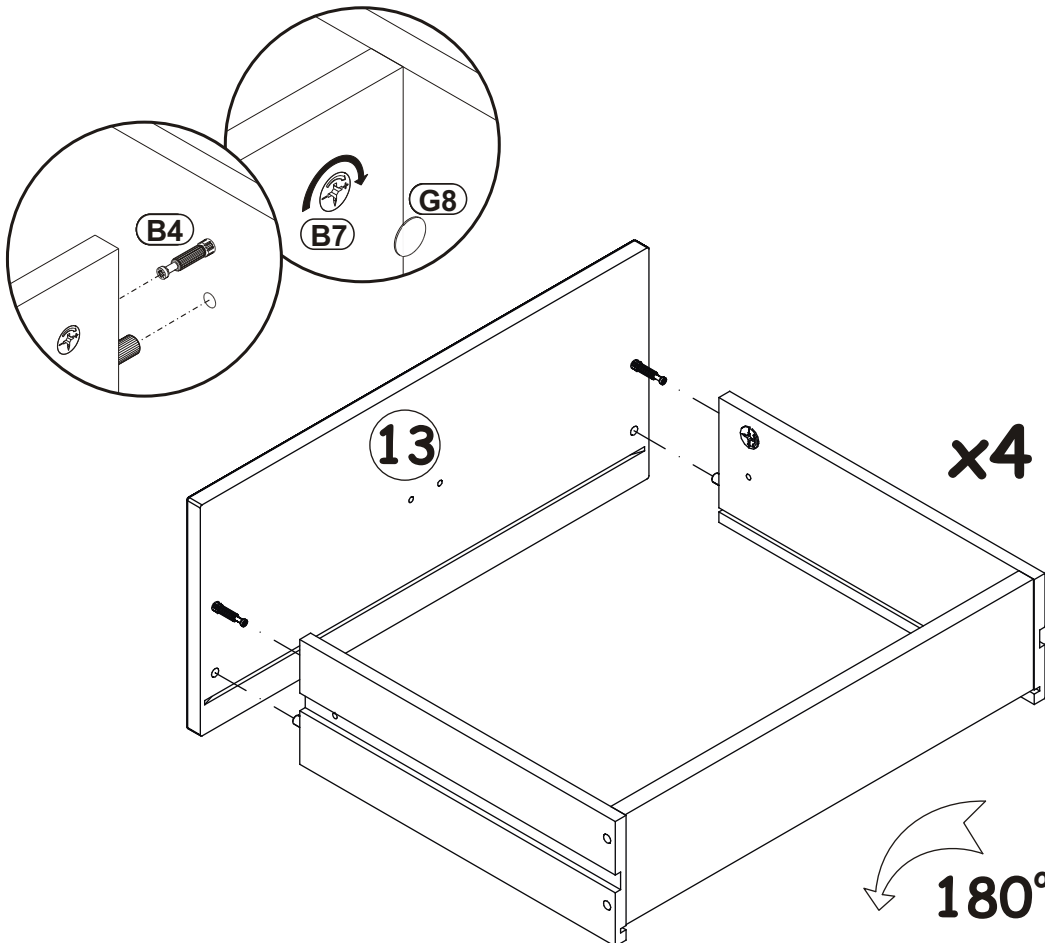

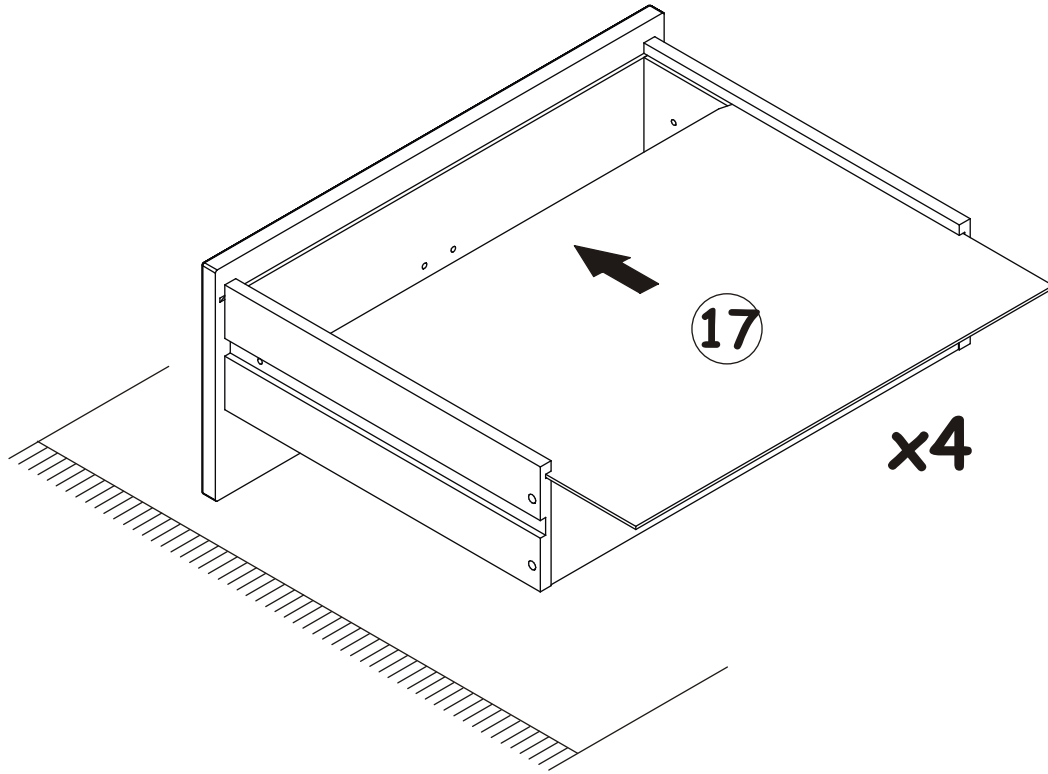

12

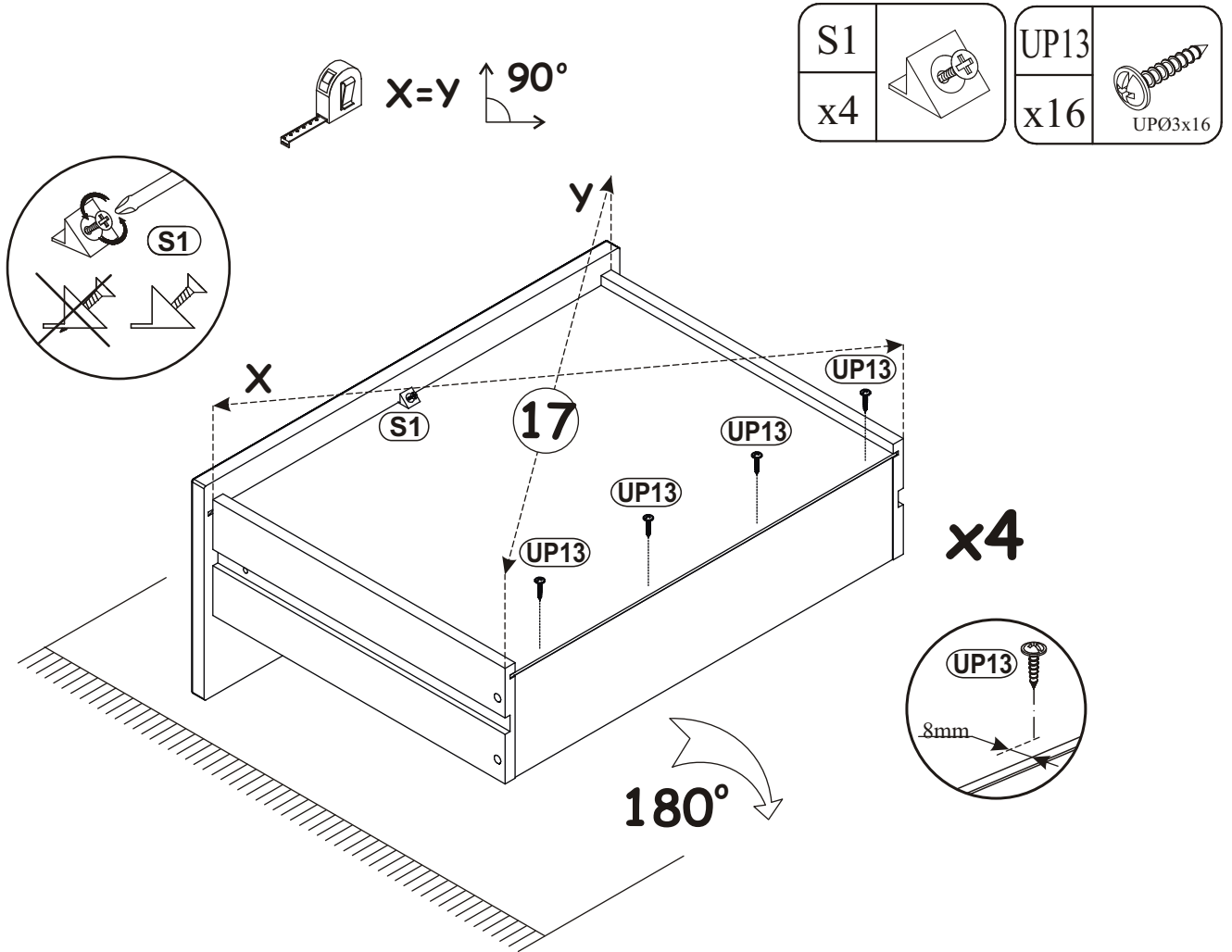

13



14

U19		D26	
x4		x8	M4x22

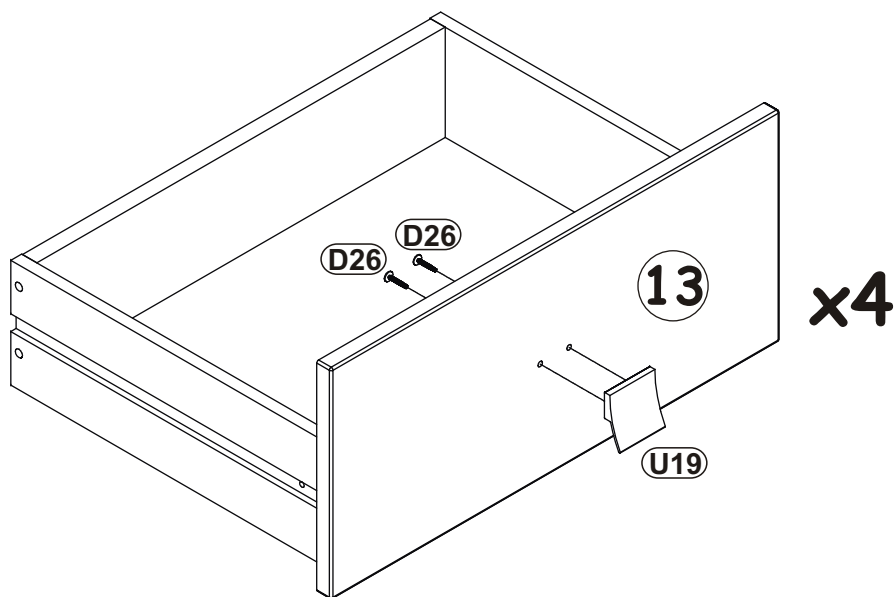

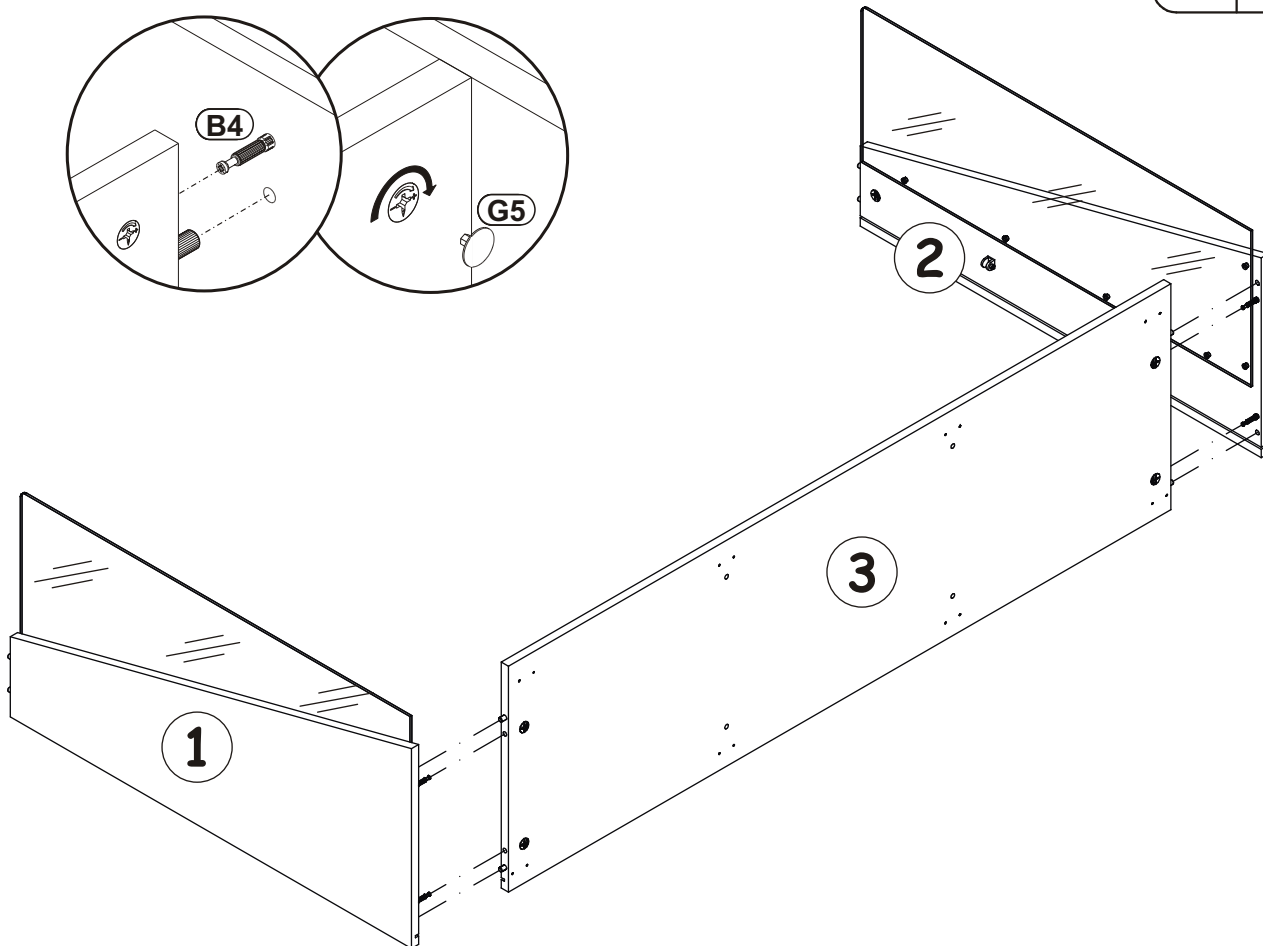

15

G5	
x4	



16

B11		G4	
x4	Ø7x50	x4	

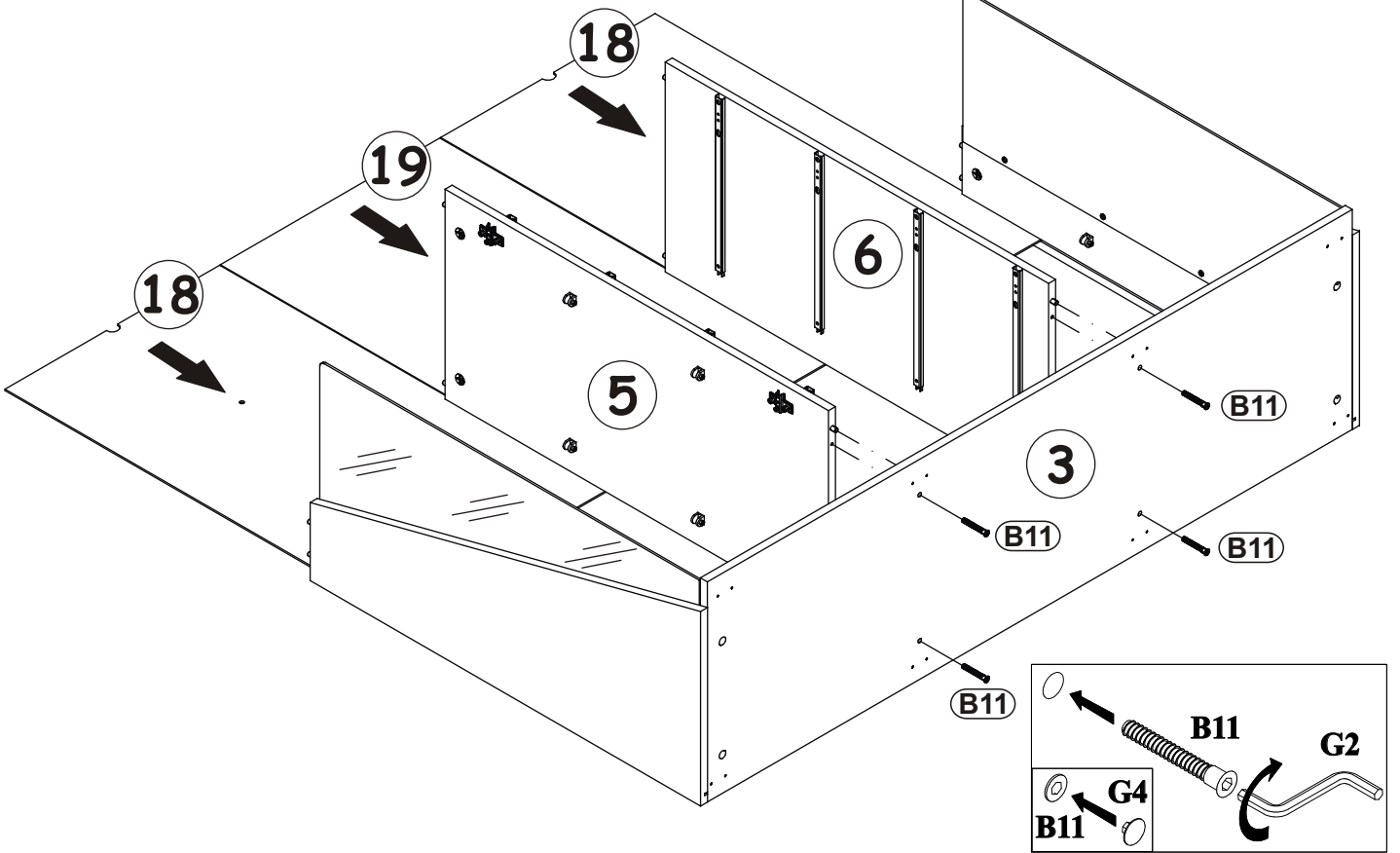

17

G5	
x6	

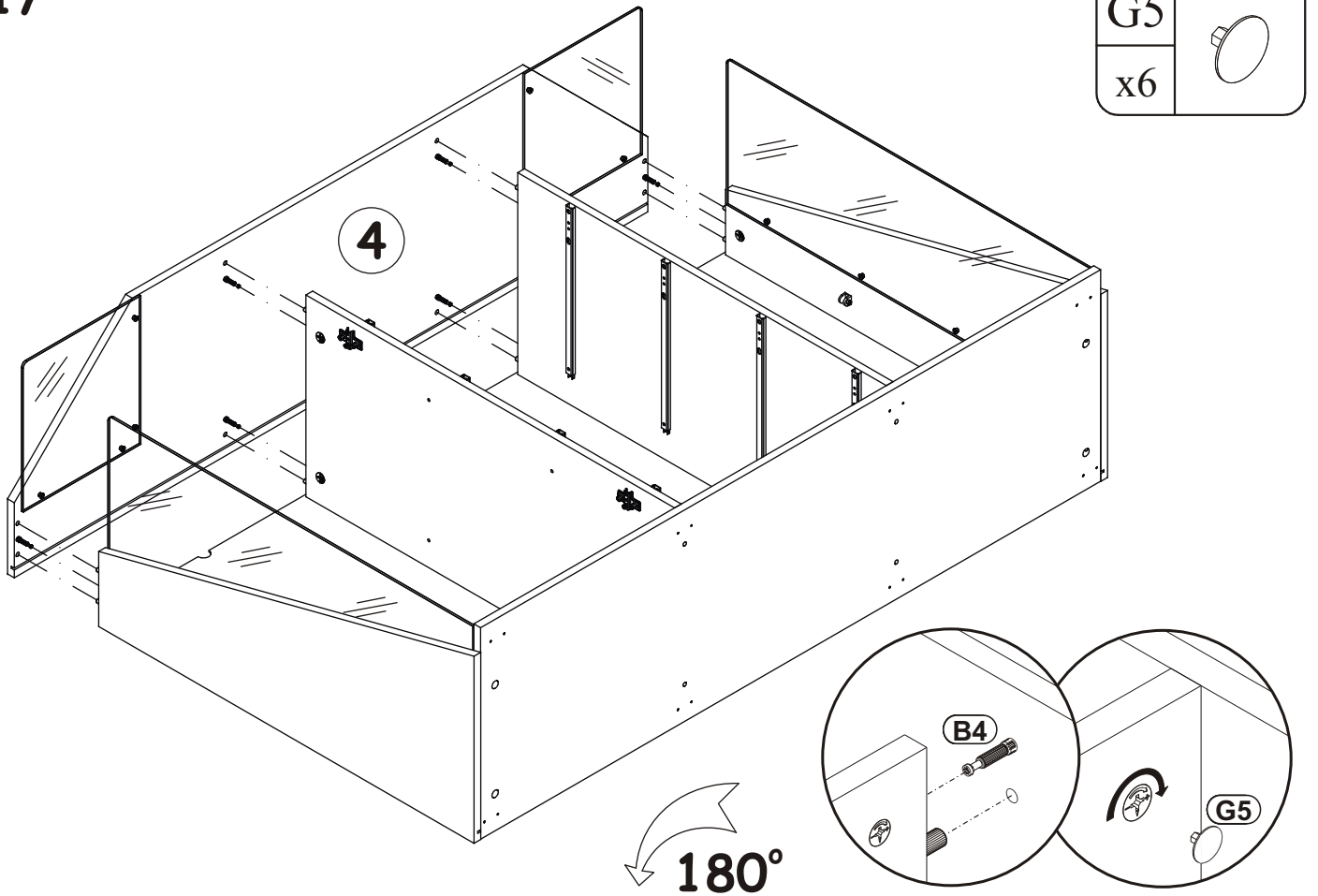

18

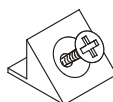
S1	
x18	

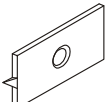
G16	
x12	

UP13	
x12	UPØ3x16

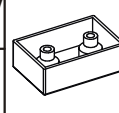

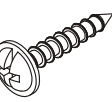
ST17	
x8	

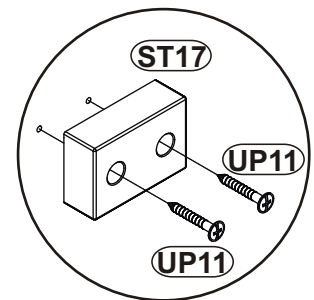
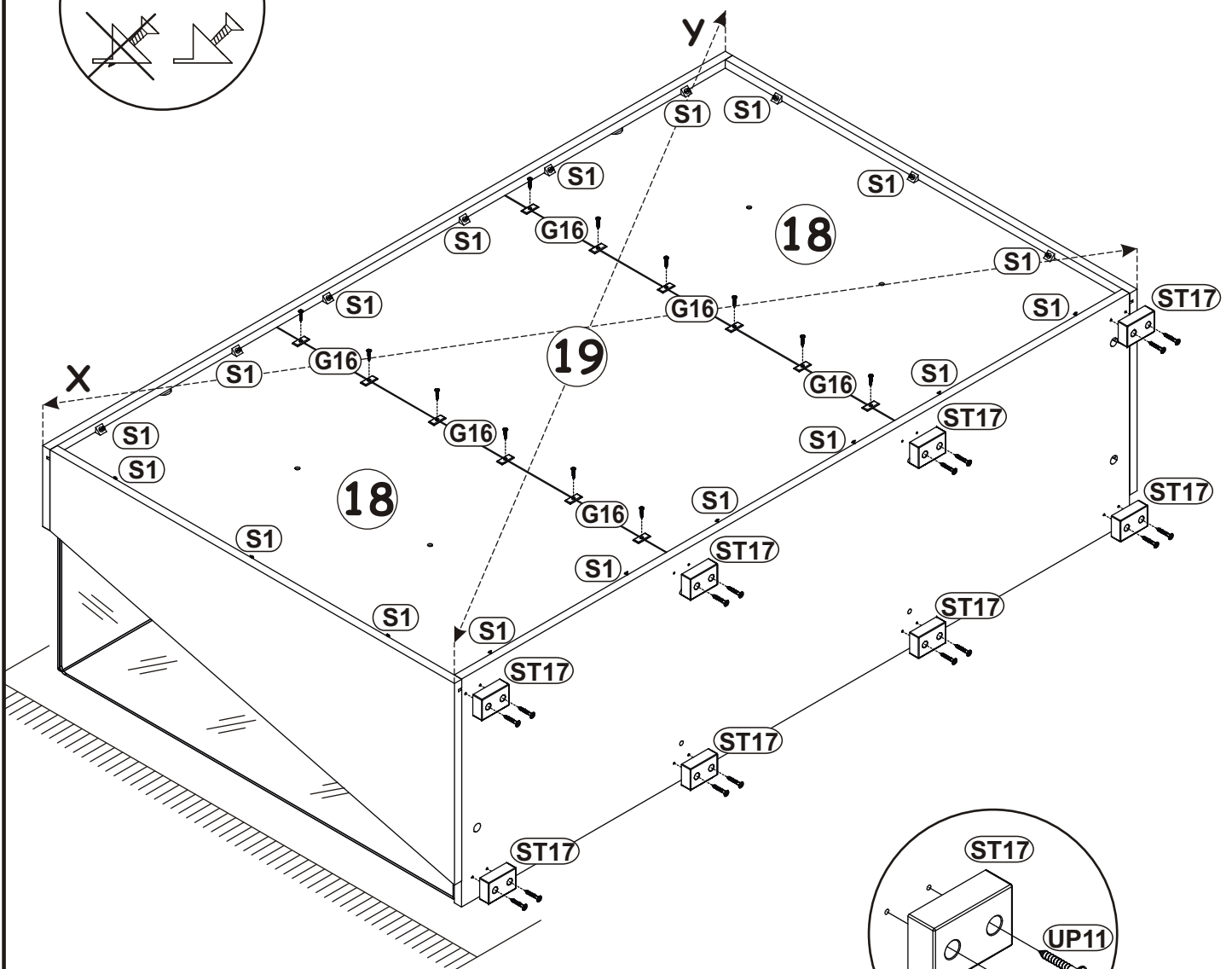
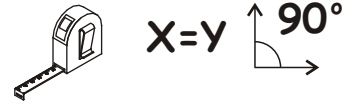
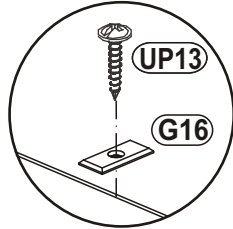
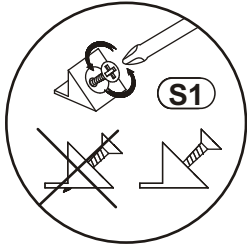
UP11	
x16	UPØ4x20

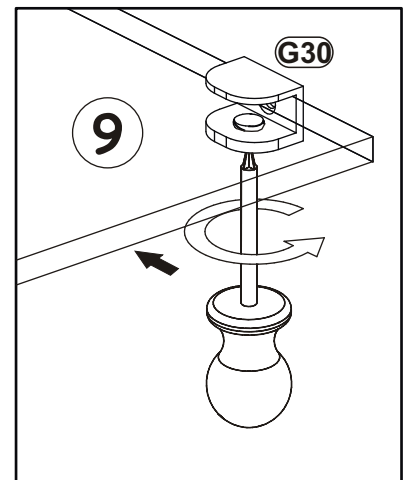
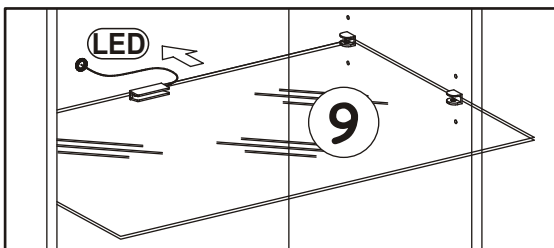
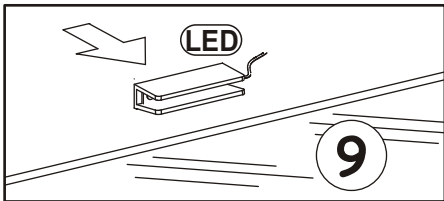
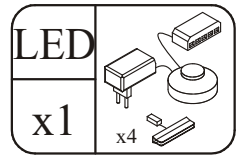

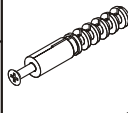
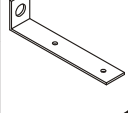

20

KR1		L1		D10	
x2		x2		x4	USØ3,5x13

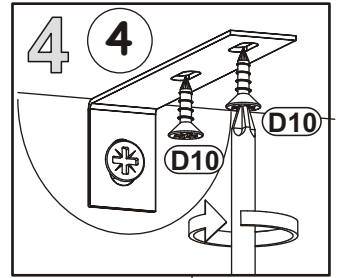
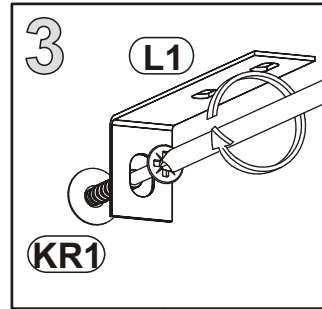
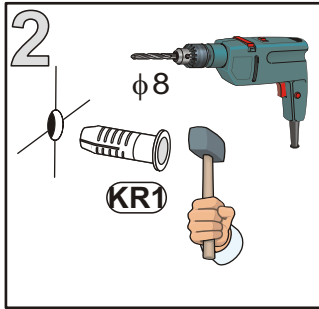
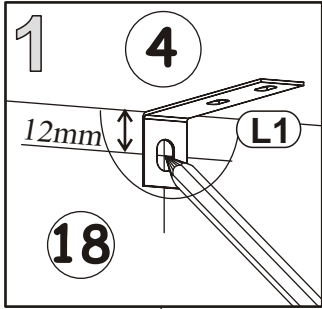
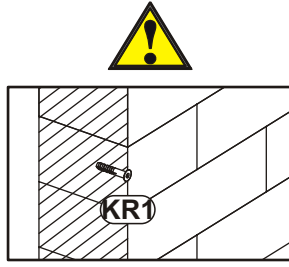
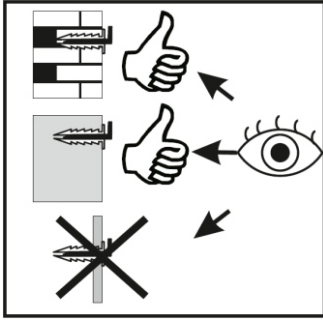

21

D18	
x8	M4x9

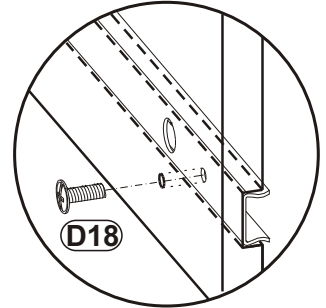
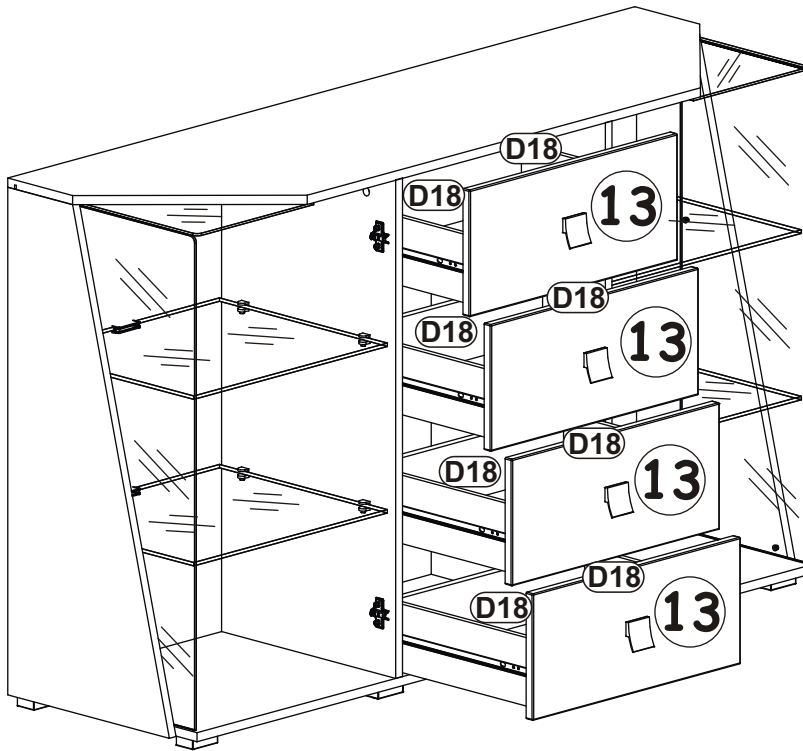

22

