

AUSTIN

AUSTIN01

OP-99

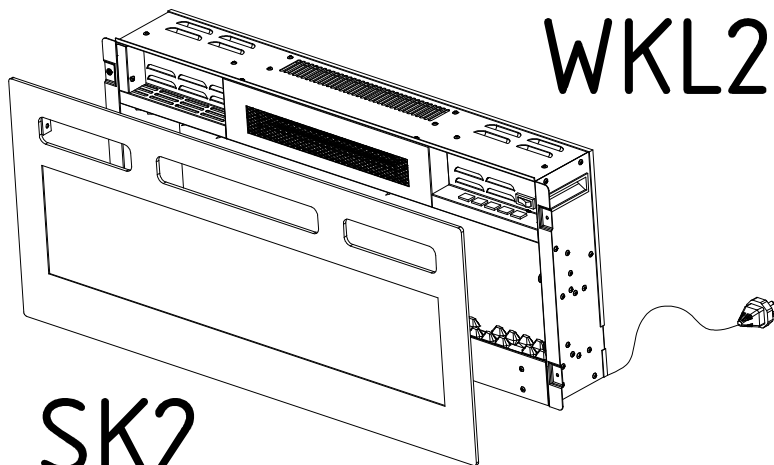
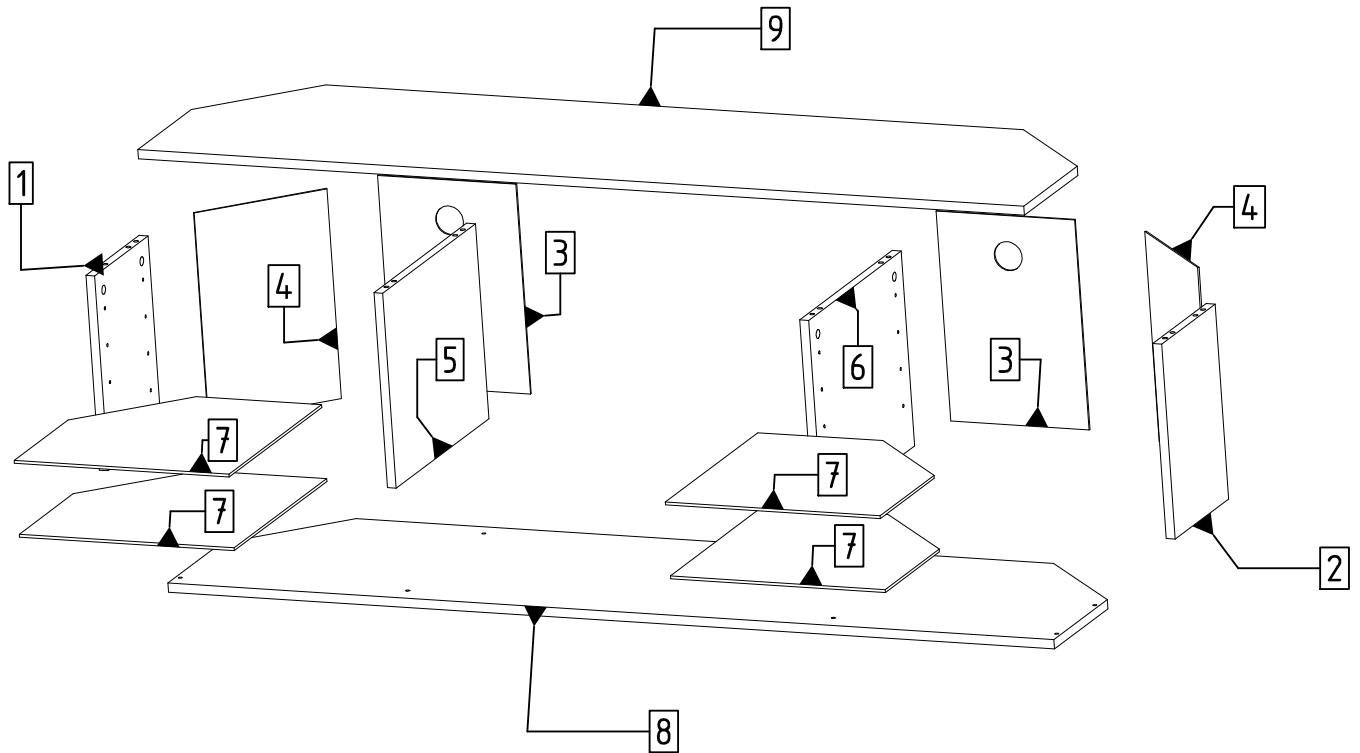
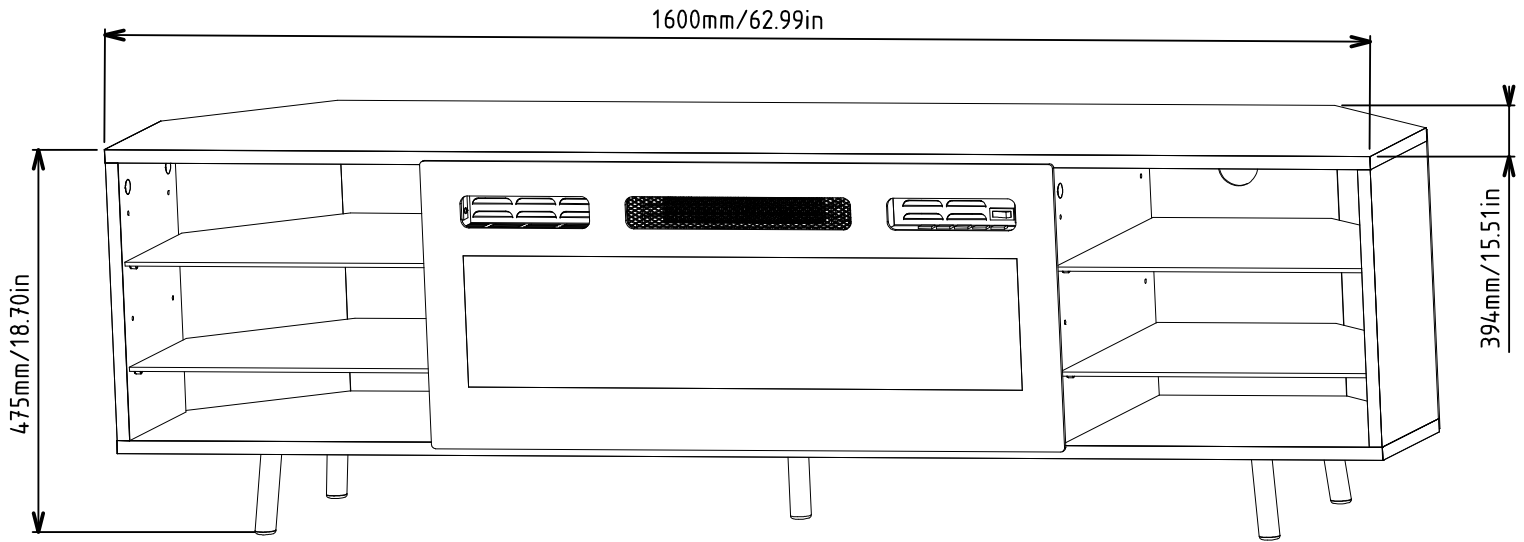
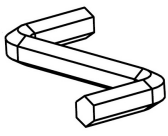
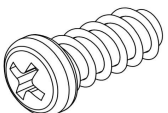
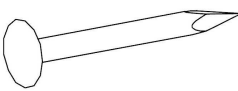
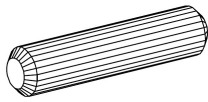
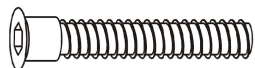

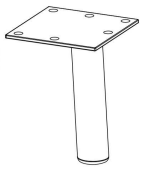
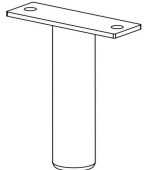
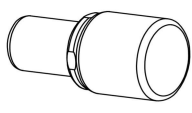
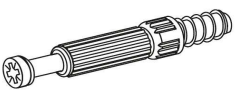
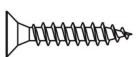
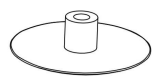
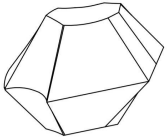
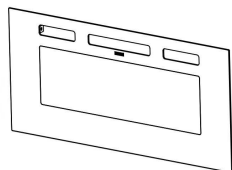
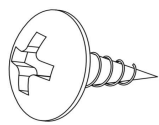
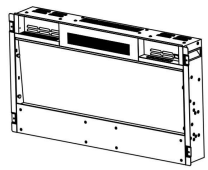
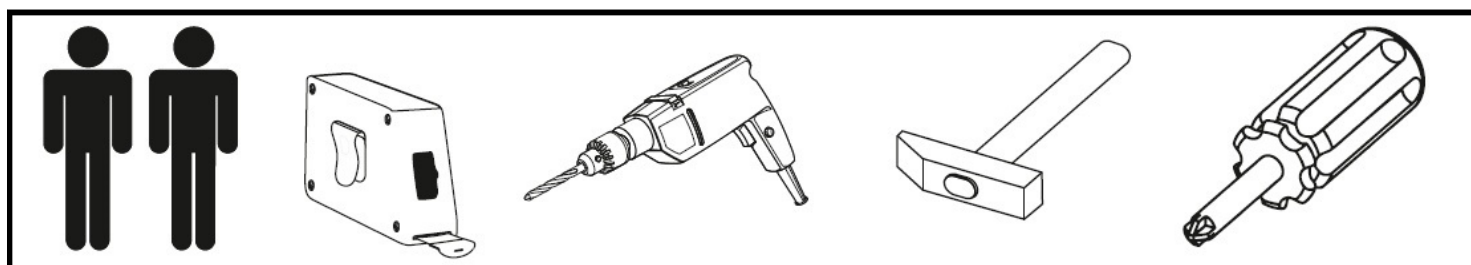

Table accessories

AUSTIN01

 A1	6,3 X 13  E13	 G	8 x 30  K	6,3 X 50  KN
15 x 12  M	 N6	 N7	 PP3	6 x 34 mm  T
4 X 25mm  W4	 Z			
 KRD	 SK2	 WK	 WKL2	

Elements				Accessories	
SYMBOL	LENGTH	WIDTH	QUANTITY	SYMBOL	QUANTITY
BL [1]	13.31	8.82	1	A1	1
BP [2]	13.31	8.82	1	E13	14
PC1 [3]	14.33	9.84	2	G	32
PC2 [4]	14.33	9.33	2	K	8
PPI01 [5]	15.28	13.31	1	KN	8
PPI02 [6]	15.28	13.31	1	KRD (attached to the electric fireplace)	62
PS [7]	15.28	15.28	4	M	8
WD [8]	62.99	15.51	1	N6	4
WG [9]	62.99	15.51	1	N7	1
				PP3	16
				SK2 (attached to the electric fireplace)	1
				T	8
				W4	4
				WK (attached to the electric fireplace)	6
				WKL2 (attached to the electric fireplace)	2
				Z	8



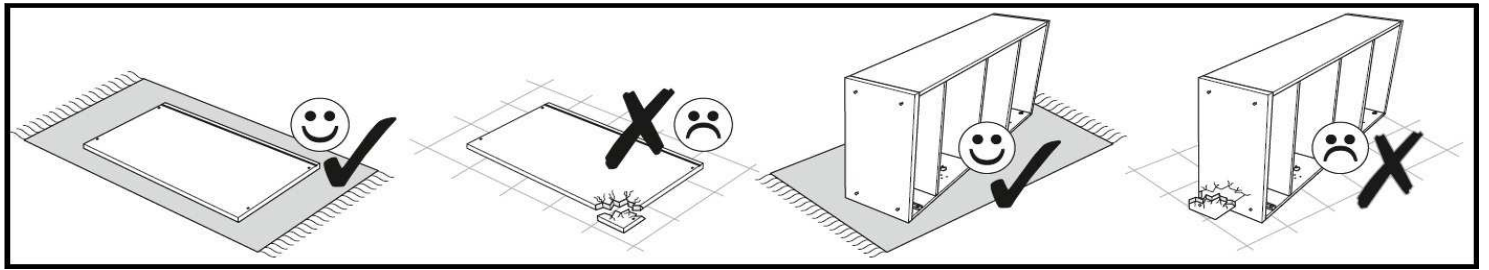

1.

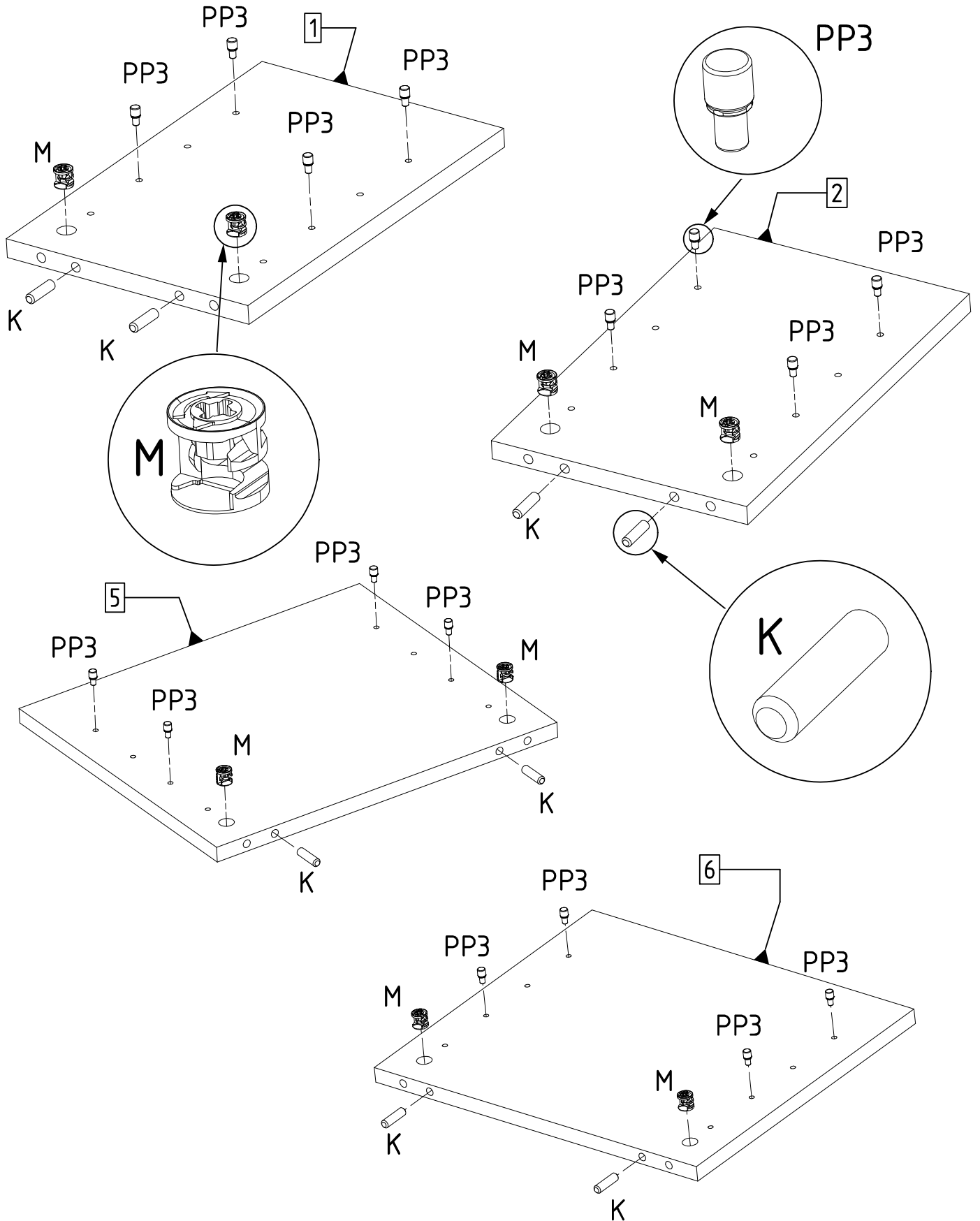

2.

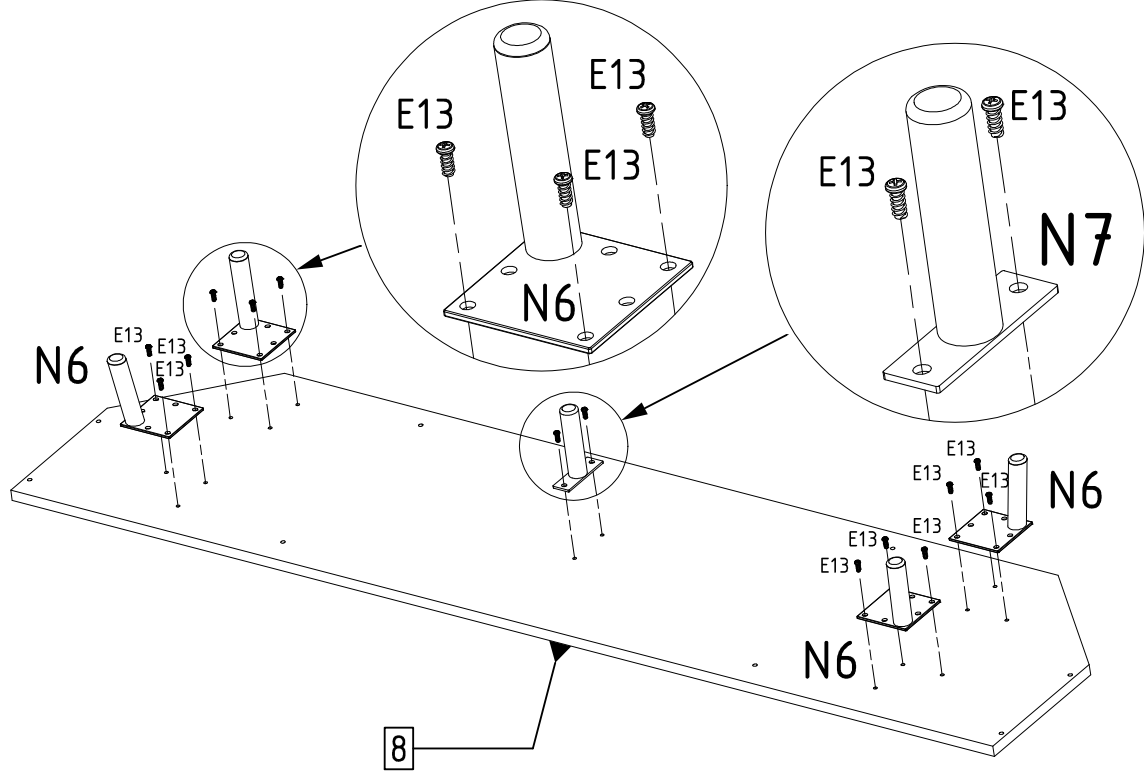

3.

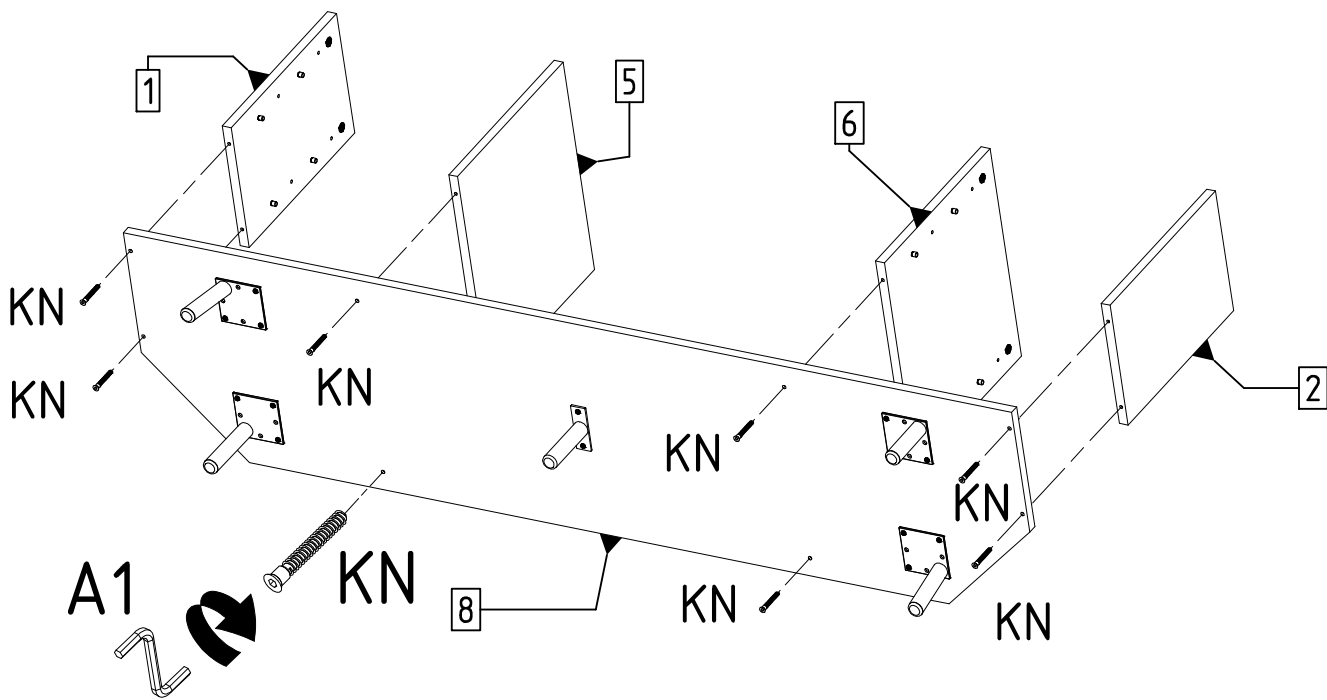

4.

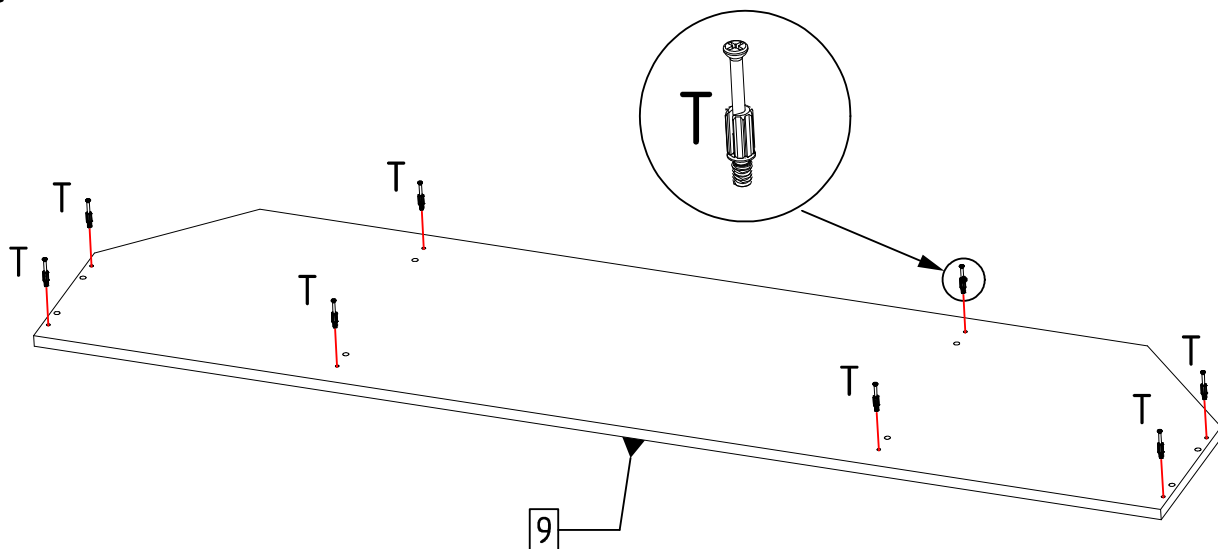

5.

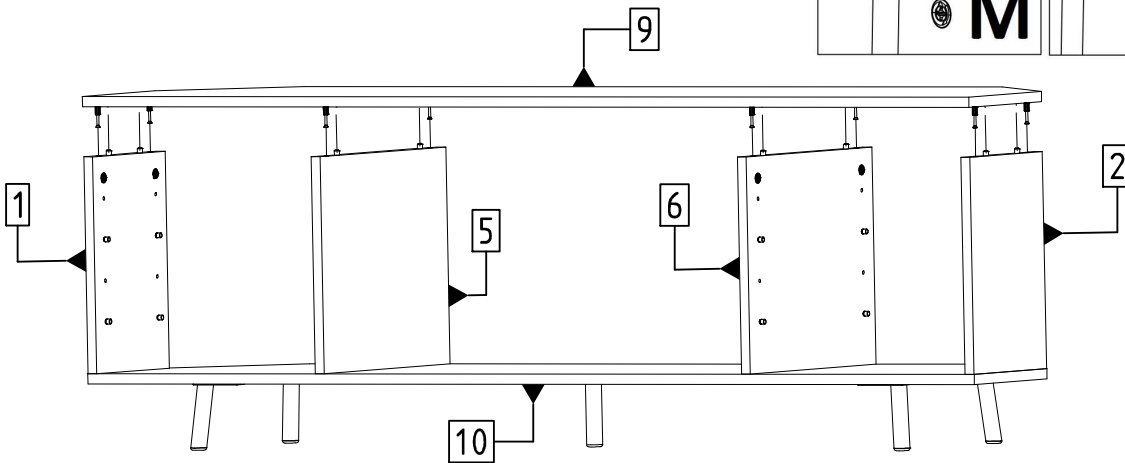
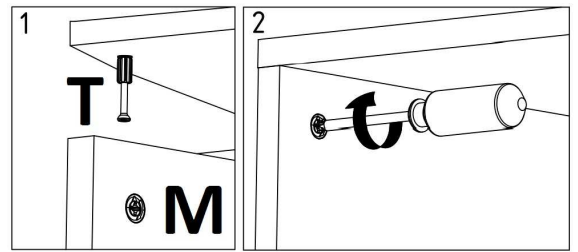

6.

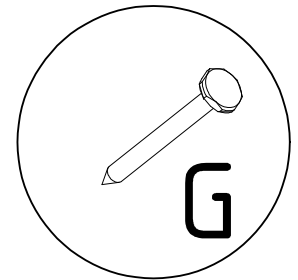
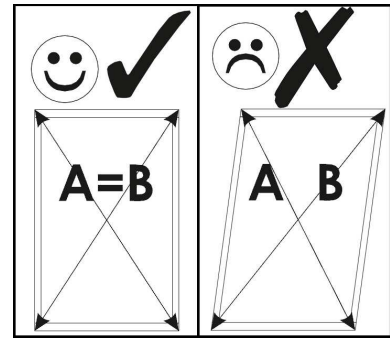
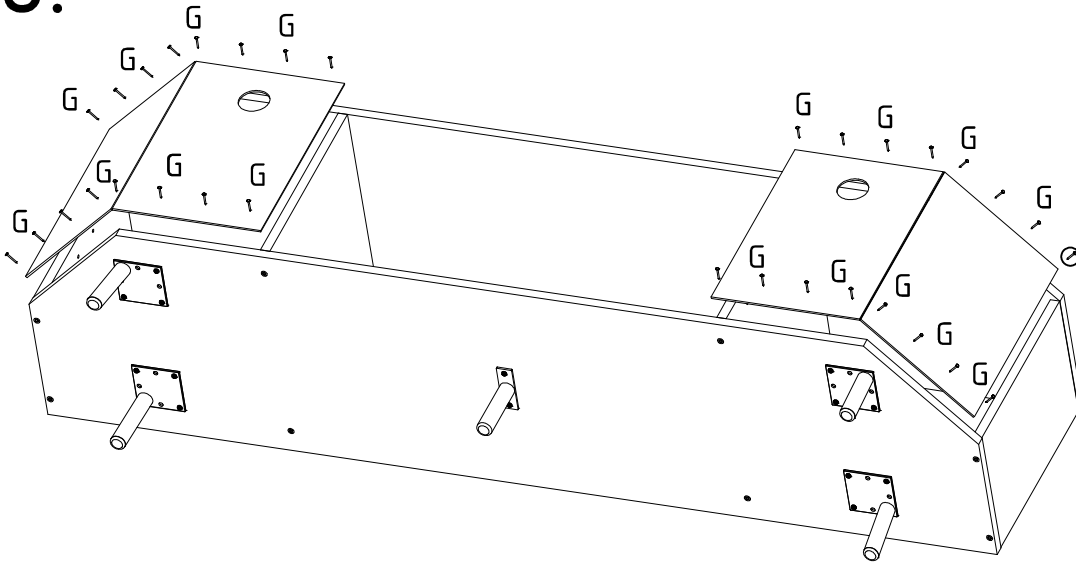

7.

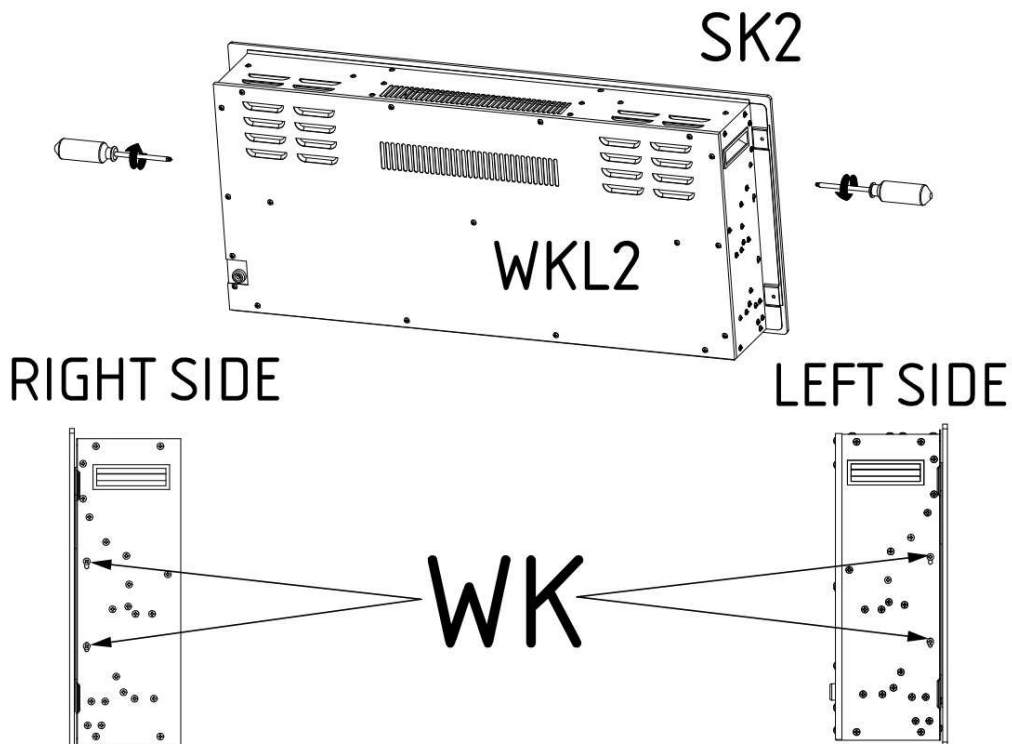

8.

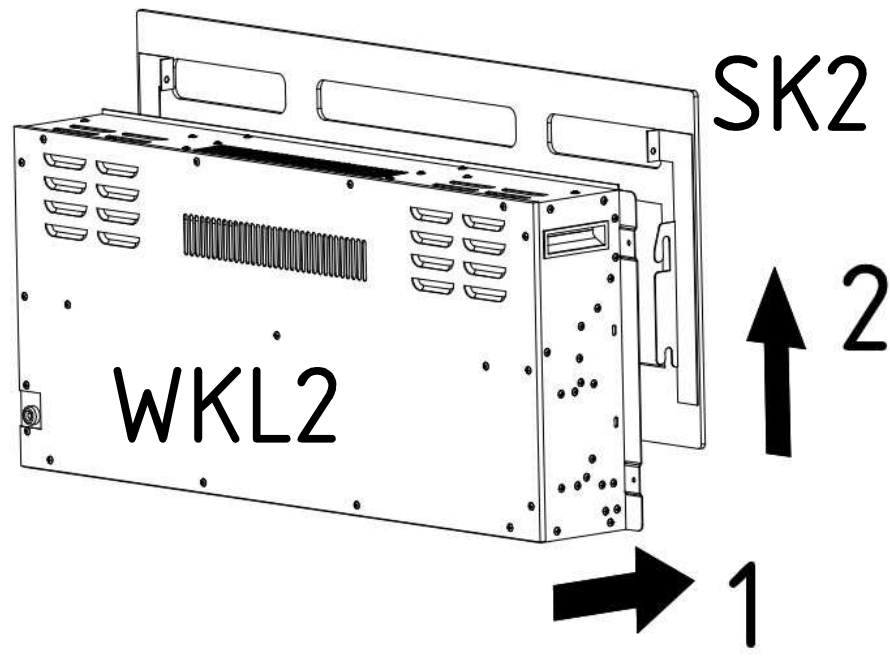

9.

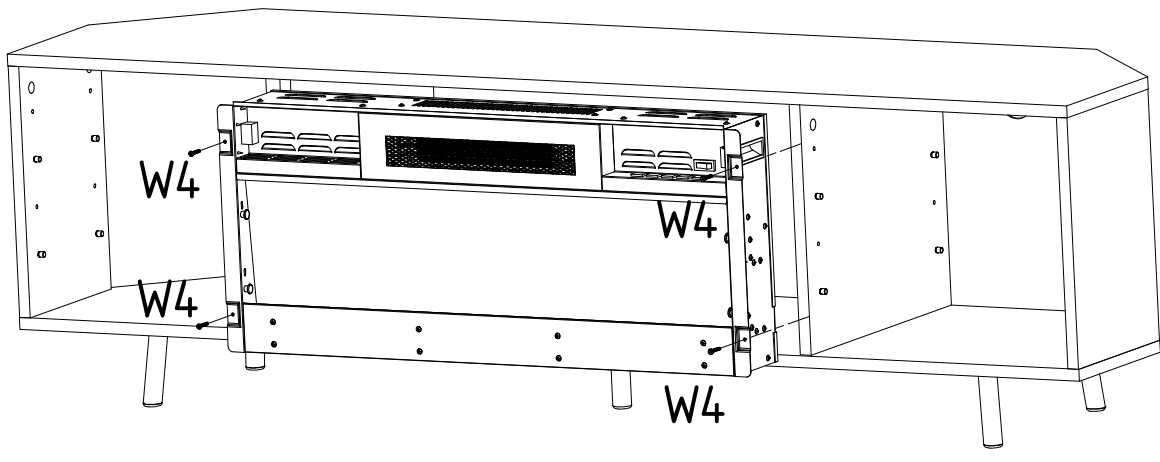

10.

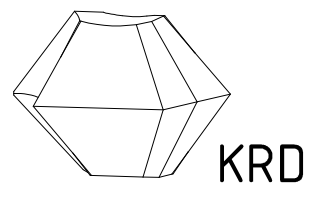
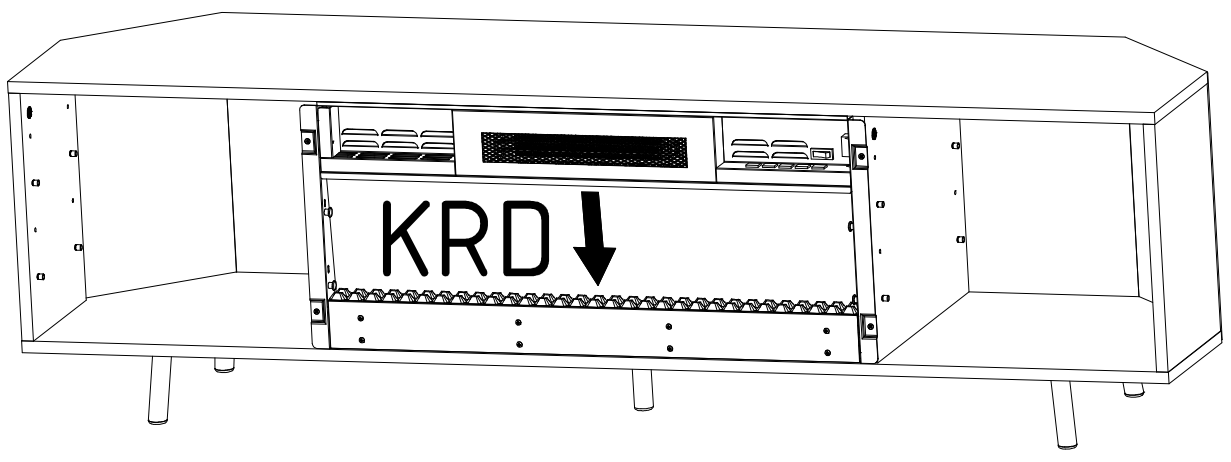

11.

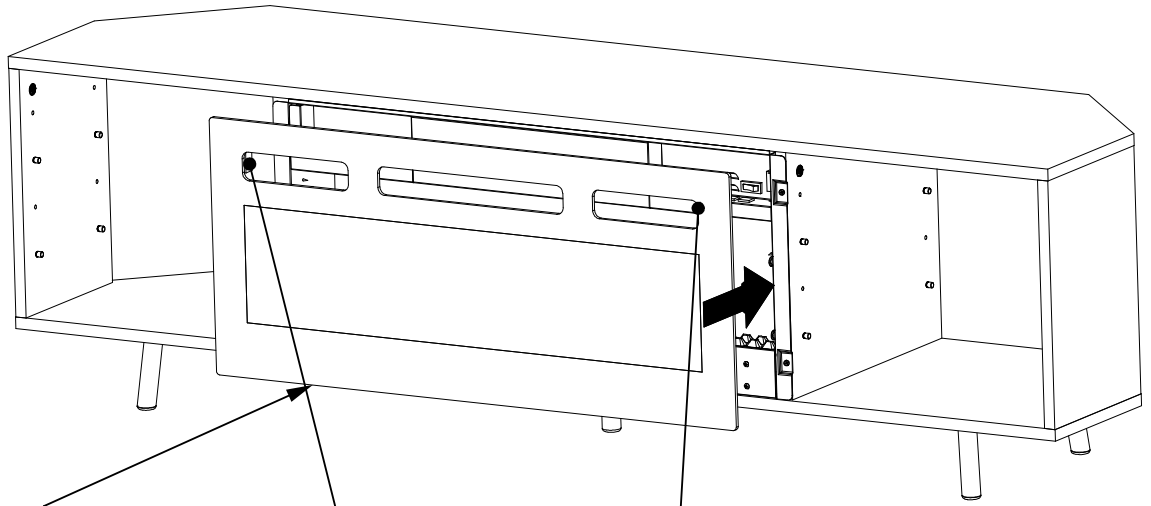

1.

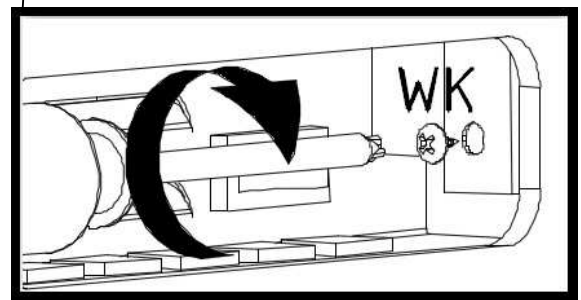
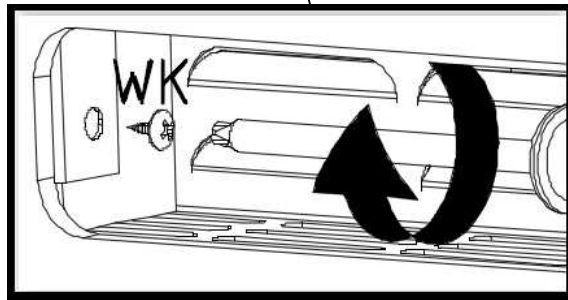
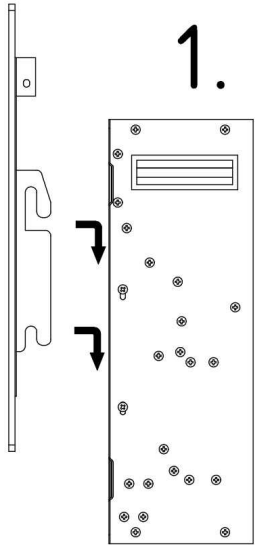

12.

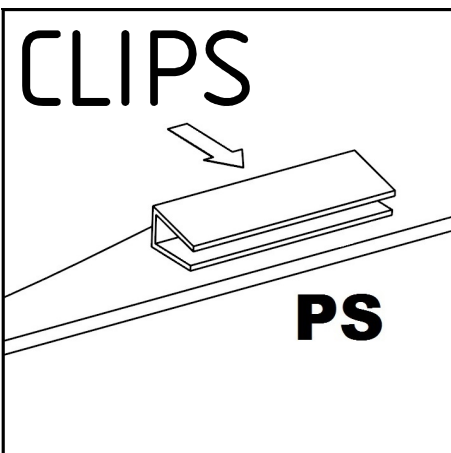
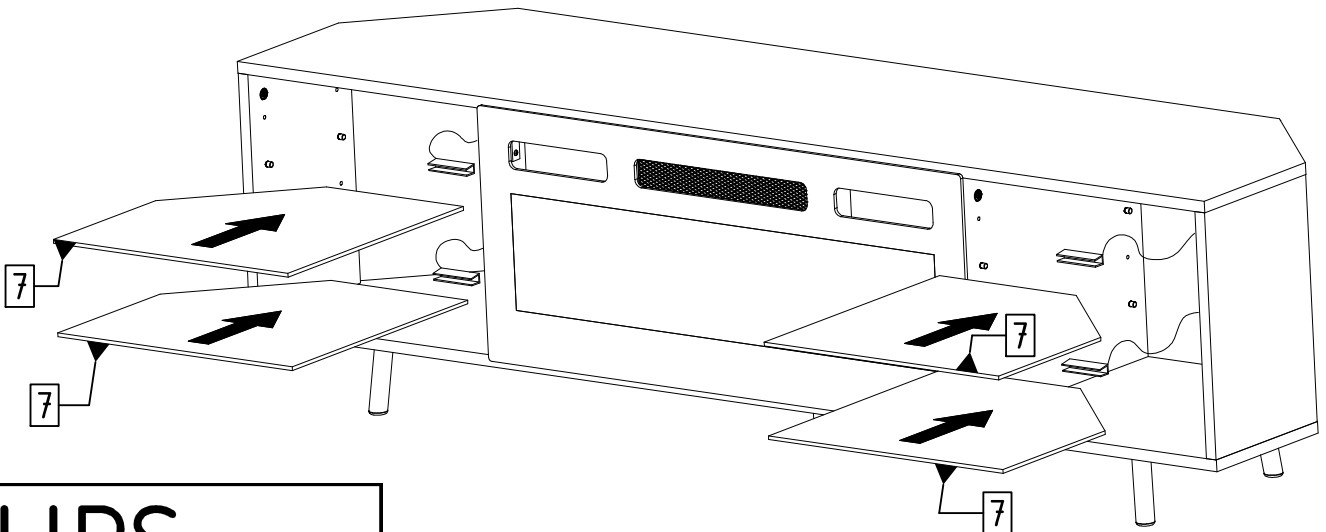

13.

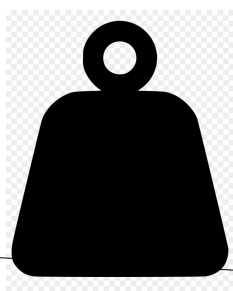
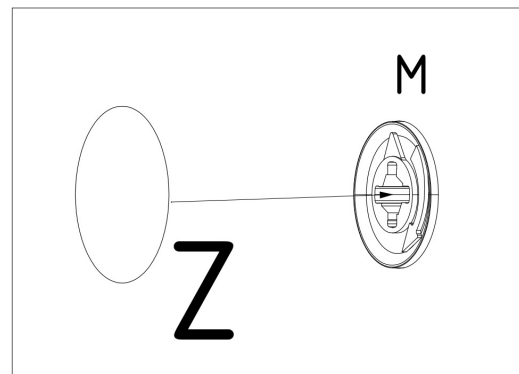

max. 20kg

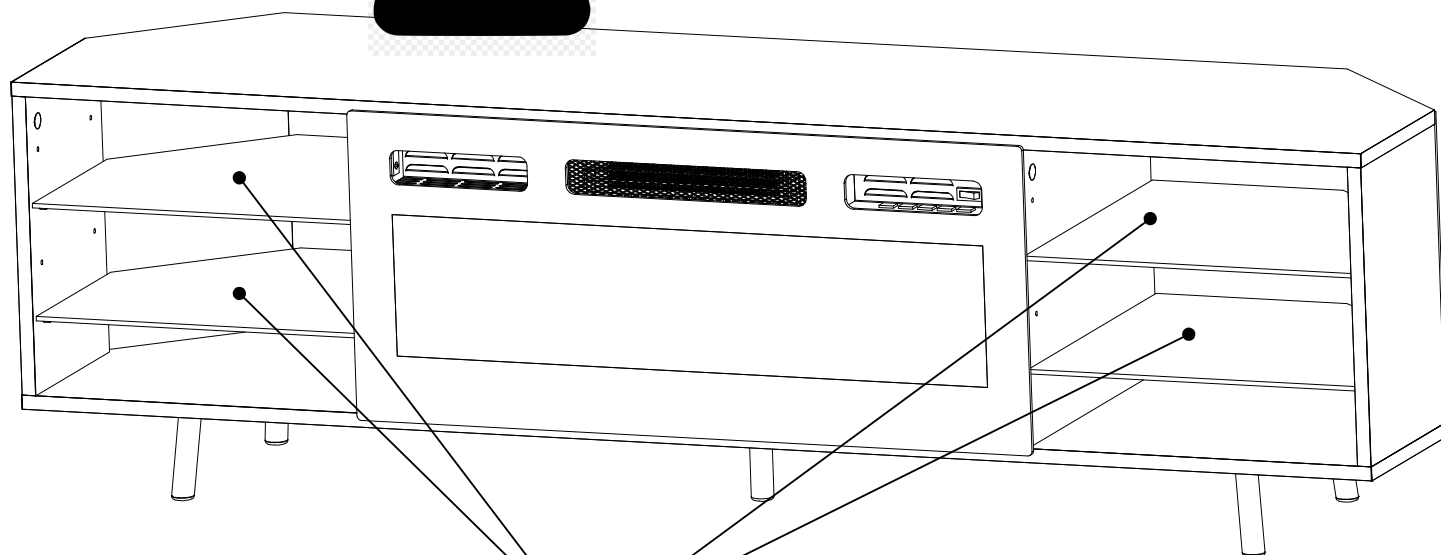

max. 3kg

