

.....

TECHNICAL DRAWING

COLLECTION: MATRIX

PRODUCT CODE: AX-MAT-150-CP

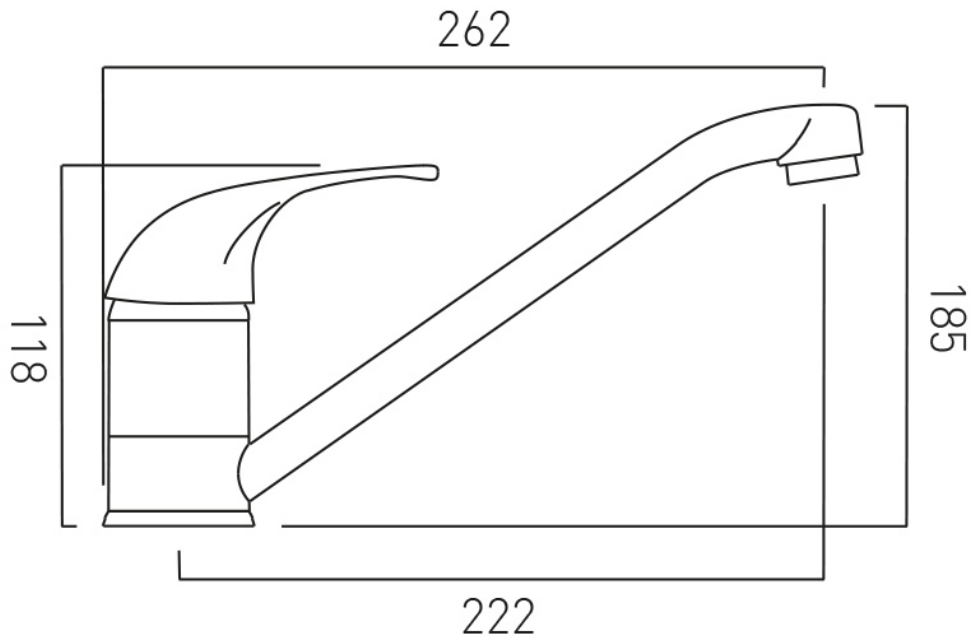

CONTACT

SALES: 01934 744466

AFTERSALES: 01934 745163

EMAIL: SALES@VADO.COM

WWW.VADO.COM/AXCES

AXCES
by VADO