

SPECIFICATION SHEET

COLLECTION: Té

PRODUCT CODE: TE-100/CC-C/P



DESCRIPTION:

mono basin mixer
single lever
deck mounted
smooth bodied
with universal basin waste
with water flow aerator
ceramic cartridge CAR-K35A
2 x 1/2" x 400mm flexipipe connections
deck mount drill hole diameter 32mm
minimum operating pressure 0.2 bar LP

FINISH:

Chrome

FLOW REGULATOR:

FR-100/5-PLA

MINIMUM OPERATING PRESSURE:

0.2 bar LP

FLOW RATE AT 3.0 BAR FLOW PRESSURE:

14 l/min

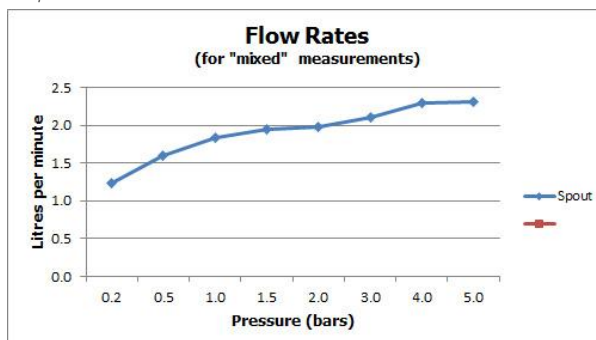

tel: 01934 744466
email: sales@vado.com
www.vado.com

where inspiration flows
taps | showering | accessories



TECHNICAL DRAWING

COLLECTION: Té

PRODUCT CODE: TE-100/CC-C/P

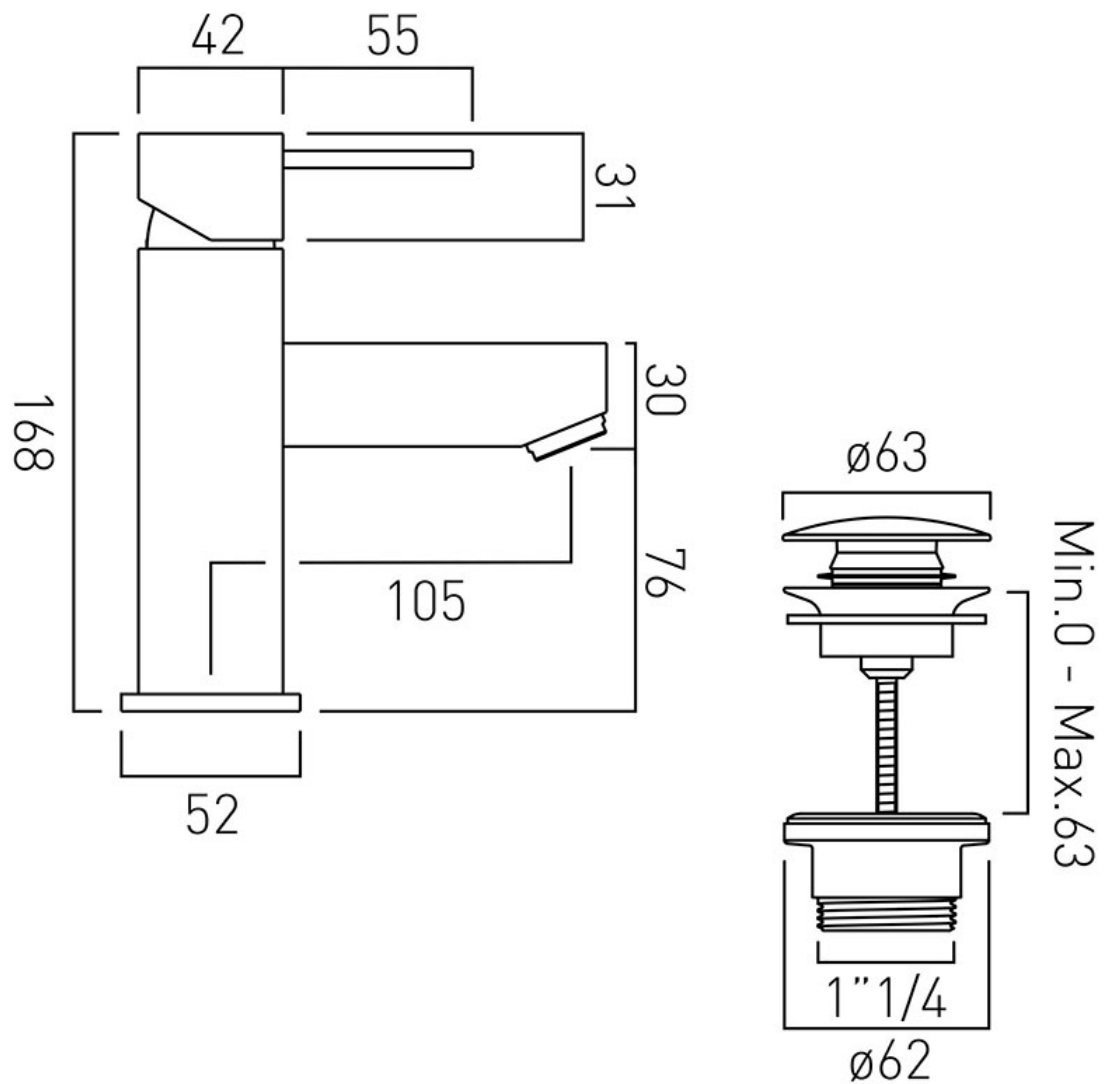

tel: 01934 744466
email: sales@vado.com
www.vado.com

where inspiration flows
taps | showering | accessories

