

Concept Freedom Ensuite Bathroom Pack with 60cm Basin & Extended Wall Hung WC - Individual Items

ILLUSTRATED

- S6402** Concept Freedom ensuite bathroom pack with 60cm basin & extended wall hung WC
- E8197** Concept Freedom wall hung elongated rimless WC pan
- S9139** Support bracket for wall mounted WC raised height with bolts
- E8226** Concept Freedom seat no cover for elongated pan
- S6362** Contemporary 21 hinged support rail, 80cm Doc M Compliant
- S6484** Contour 21 Contemporary grab rail 60cm long
- S6637** Multi-System back support, white, complete with cushion
- E5499** Concept Freedom 60cm accessible washbasin, one taphole
- B9918** Concept Blue washbasin mixer 1 hole
- A5900** TMV Thermostatic mixing valve 15mm
- E0079** Trap 1¼" Contemporary metal bottle, 75mm seal
- S8803** Waste 1¼" Click plug waste, 80mm slotted tail
- S6486** Contour 21 Contemporary grab rail 45cm long
- S3636** Conceala 2 cistern delay fill 4.5/3 or 4/2.6 litre dual flush valve bottom supply and internal overflow, alternative height plastic flushbends, no flushplate
- E4465** Karisma flush plate dual flush, branded for Conceala 2 cisterns, chrome
- S4302** Contour 21 flushpipe constructed, necessary for installation

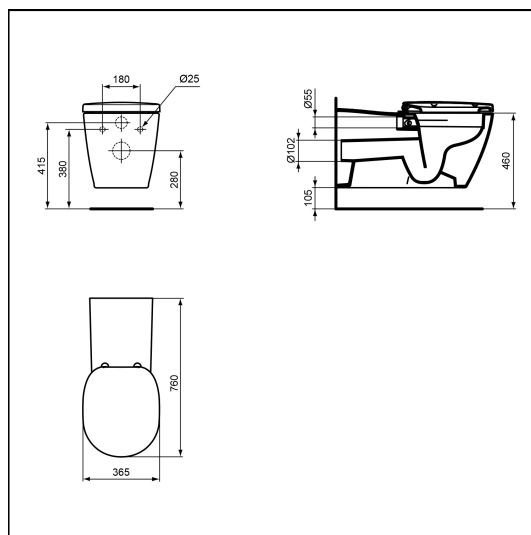
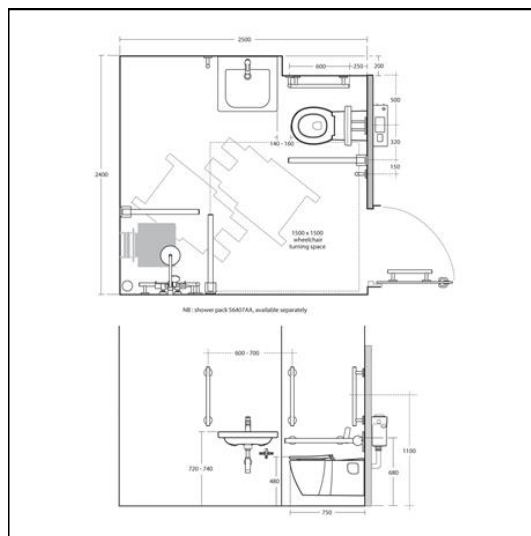

ILLUSTRATED PRODUCT DETAILS

Sizes

E5499 w:600 x d:555













Weights

- S6402** 72.96 KG
- E8197** 33.00 KG
- S9139** 4.28 KG
- E8226** 1.40 KG
- S6362** 3.00 KG
- S6484** 4.26 KG
- S6637** 3.63 KG
- E5499** 14.00 KG
- B9918** 1.52 KG
- A5900** 0.60 KG
- E0079** 1.45 KG
- S8803** 1.00 KG
- S6486** 3.20 KG
- S3636** 3.00 KG
- E4465** 0.50 KG
- S4302** 0.39 KG

Materials

- S6402** Chrome Plated Metal & Vitreous China
- E8197** Vitreous China
- S9139** Metal
- E8226** Plastic
- S6362** Aluminium





Finishes

- S6402**  Chrome (AA)
- E8197**  White (01)
- S9139**  Neutral / No Finish (67)
- E8226**  White (01)
- S6362**  Chrome finish (AA)
- S6484**  Chrome finish (AA)
- S6637**  White (AC)
- E5499**  White (01)
- B9918**  Chrome (AA)
- A5900**  Chrome (AA)
- E0079**  Chrome (AA)
- S8803**  Chrome (AA)

FEATURES



Concept Freedom Ensuite Bathroom Pack with 60cm Basin & Extended Wall Hung WC - Individual Items

S6484	Aluminium	S6486	 Chrome finish (AA)
S6637	Mixed Material	S3636	 Neutral / No Finish (67)
E5499	Vitreous China	E4465	 Chrome (AA)
B9918	Chrome Plated Brass	S4302	 Neutral / No Finish (67)
A5900	Chrome Plated Metal		
E0079	Chrome Plated Metal		
S8803	Chrome Plated Metal		
S6486	Aluminium		
S3636	Plastic		
E4465	Chrome Plated Plastic		
S4302	Plastic		

Capacity

E5499	4 litres
S3636	5 litres









Flow rates

B9918	5 Litres per minute @ 3 bar pressure
--------------	--------------------------------------

Designer

Robin Levien, RDI

FINISH OPTIONS

		
(AA) Chrome finish	(MY) Stainless Steel finish	(MY) Stainless Steel finish
		
(AA) Chrome	(GN) Ultra Steel	(01) White
		
(36) Light Blue	(GQ) Red	(79) yellow

Special Notes

Supplied with layout drawings, detailing the fixing postions necessary for DOC M compliance