

Sales Code: STY059

Description: Rectangular Slide Rail Kit

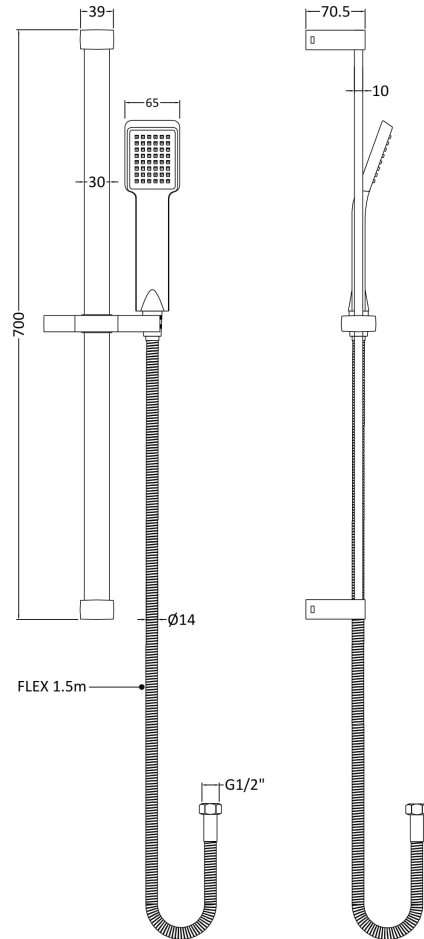

Product Dimensions

Length (mm):	
Width (mm):	660
Height (mm):	660
Depth (mm):	70
Nett Weight (kg):	0.9

Packaging Dimensions

Length (mm):	668
Width (mm):	153
Height (mm):	
Gross Weight (kg):	0.9

Packaging Data

Box Colour:	White Cardboard Box
Box Qty:	1
Label Size:	100 x 50
Label Colour:	White Label
Label Qty:	2

Outer Box Dimensions (If Applicable)

Length (mm):	
Width (mm):	
Height (mm):	
Depth (mm):	
Gross Weight (kg):	11
Barcode:	5055369015870

Product Details

Country of Origin:	China
Fitting Instruction:	No
Product Material:	Brass/ABS
Mount Type:	Surface, Wall
Outlet Elbow Supplied:	No
Easy Clean:	Yes
Head Included:	No
Handset Included:	Yes
Body Jets Included:	No
No of Body Jets:	Not Applicable
Operating Pressure (bar):	0.1
Valve/Cartridge Type:	Not Applicable
Flow Rates (L/min):	0.1 bar: N/A 0.5 bar: N/A 1 bar: N/A 2 bar: N/A 3 bar: N/A
TMV2 Approved:	No Approval No: N/A
TMV3 Approved:	No Approval No: N/A
WRAS Approved:	No Approval No: N/A
Head Function:	Not Applicable
Handset Function:	Single Setting
Body Jet Info:	Not Applicable
Pipe Size:	15 mm (1/2" Bsp)
Pipe Centres:	N/A
Colour/Finish:	Chrome
Hose Included:	Yes
No. of Outlets:	1