

Sales Code: LEG3S

Description: Suitable For 1100-1200 Rec Trays

### Packaging Details

Barcode: 5056211868859

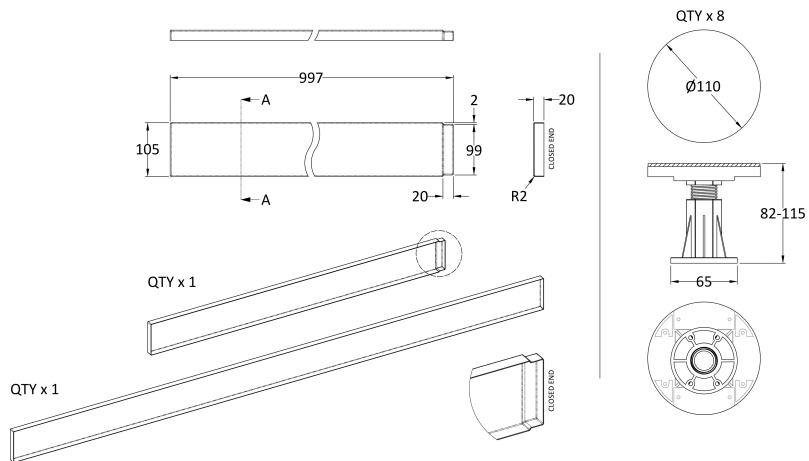
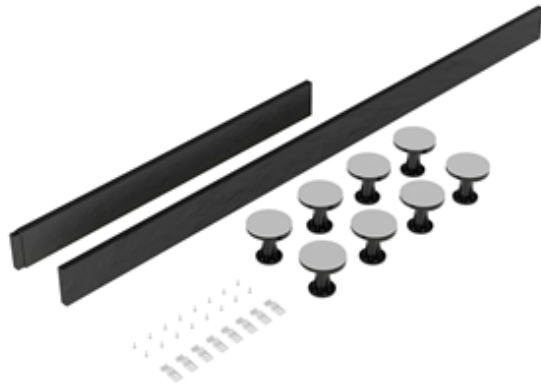

**Sales Code:** TR71575

**Description:** 1800 Tray Panel

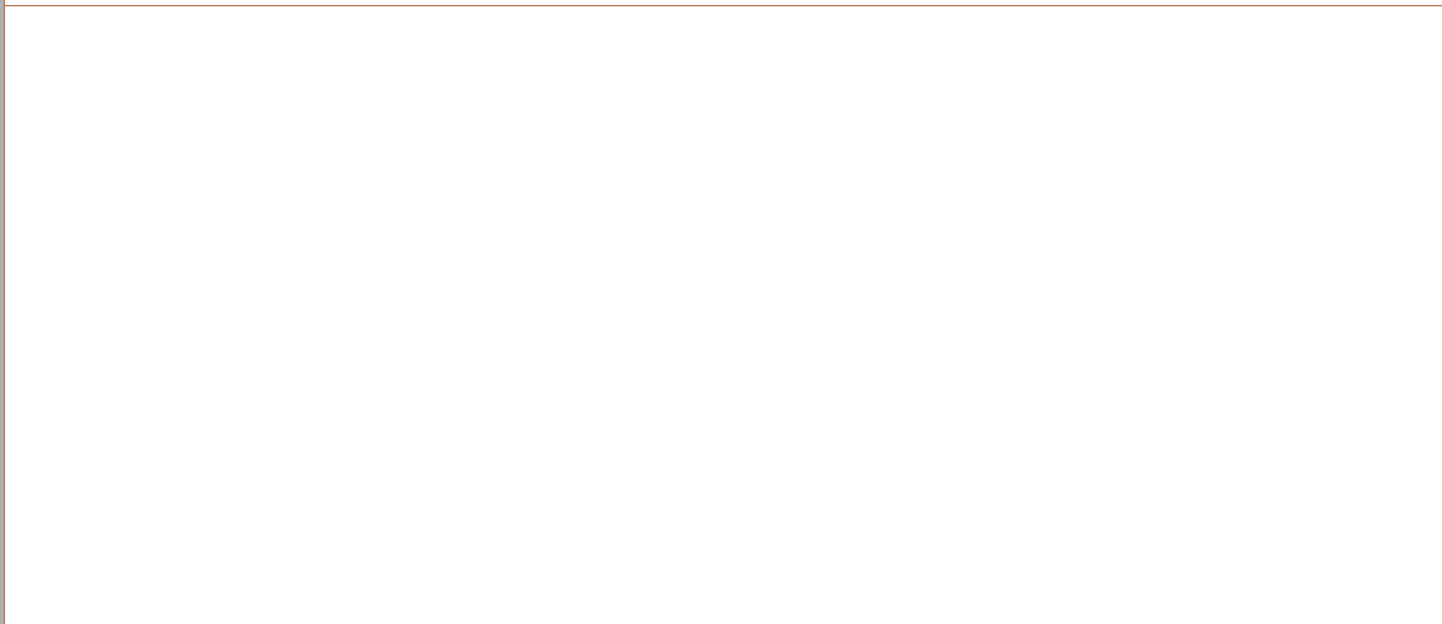
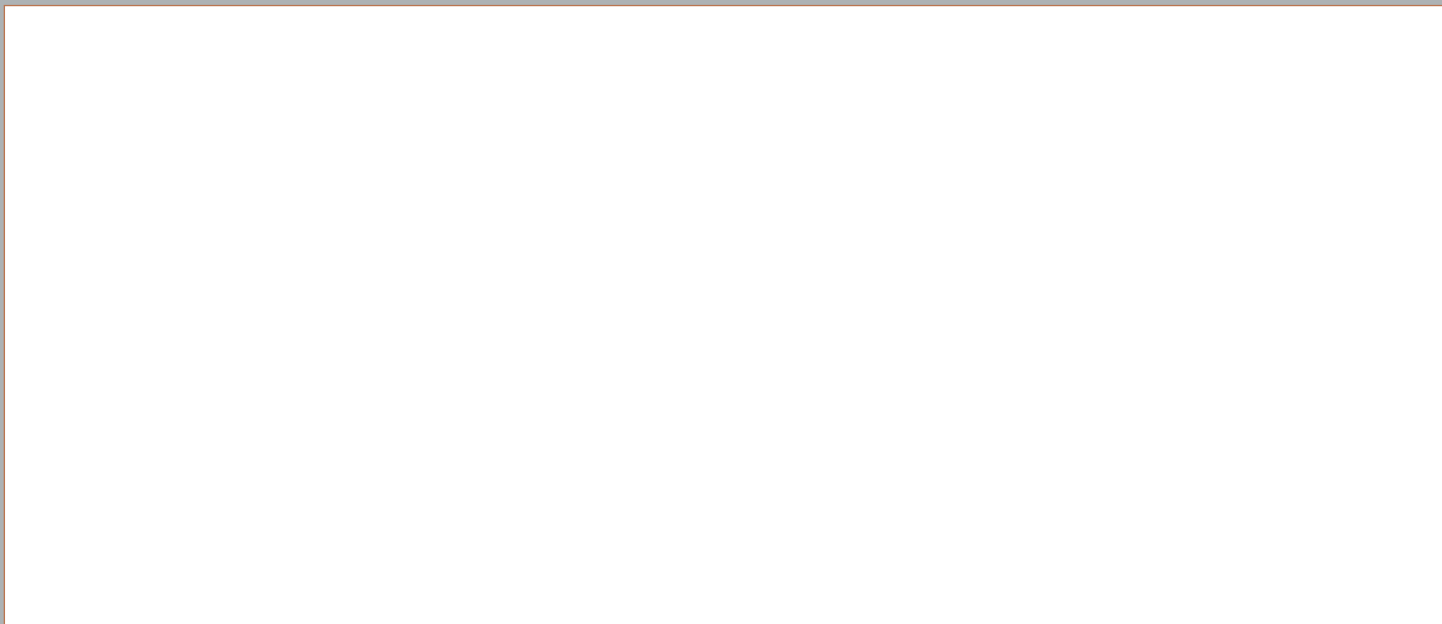

**Product Dimensions**

Length (mm):	1800
Width (mm):	105
Height (mm):	12
Nett Weight (kg):	0.5

**Packaging Dimensions**

Length (mm):	1810
Width (mm):	110
Height (mm):	15
Gross Weight (kg):	0.5

**Packaging Data**

Box Colour:	Polybagged
Box Qty:	1
Label Size:	100 x 50
Label Colour:	White Label
Label Qty:	2

**Outer Box Dimensions (If Applicable)**

Length (mm):	
Width (mm):	
Height (mm):	
Gross Weight (kg):	
Barcode:	5056211855491

**Product Details**

Country of Origin:	United Kingdom
Fitting Instruction:	No
CE Certification:	
Colour/Finish:	White
Product Material:	Acrylic Capped ABS
Material Colour Reference:	Slate Grey
Radius:	0
Waste Required (mm):	
Compatible with Leg Kit:	Not Applicable

**Sales Code:** TR71515

**Description:** 1000 Tray Panel (1000 X 105 X 12)

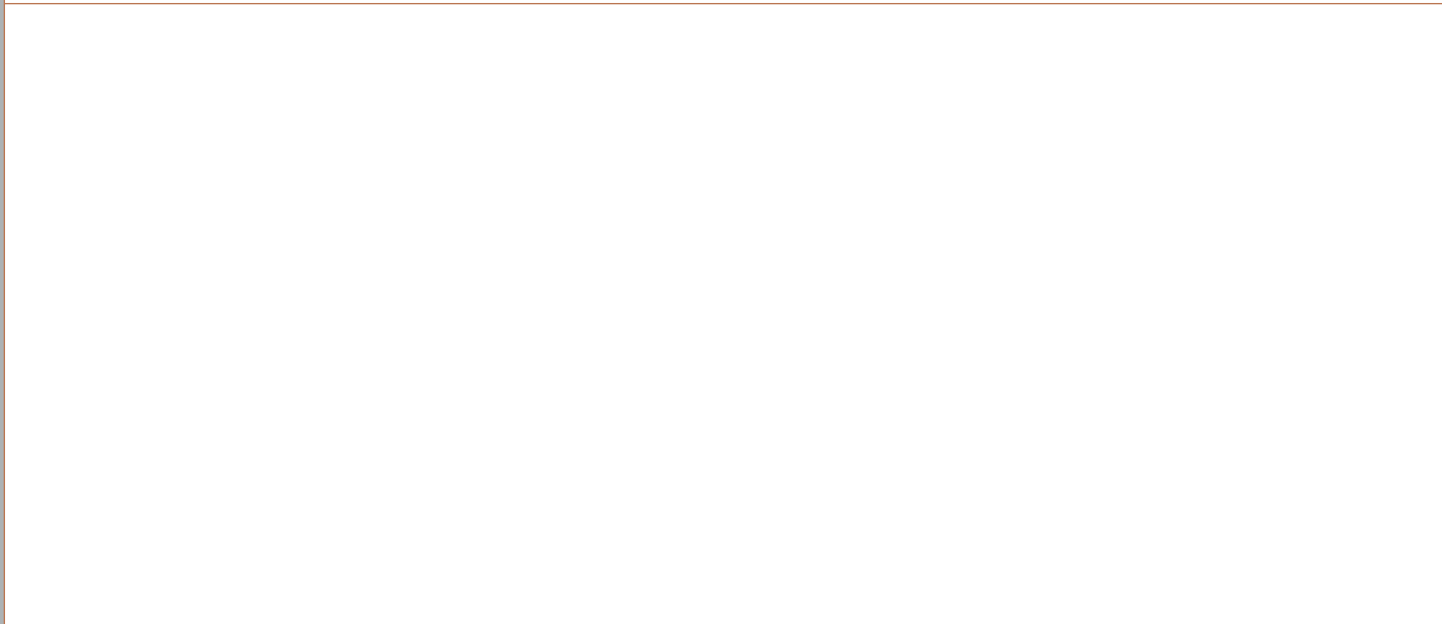
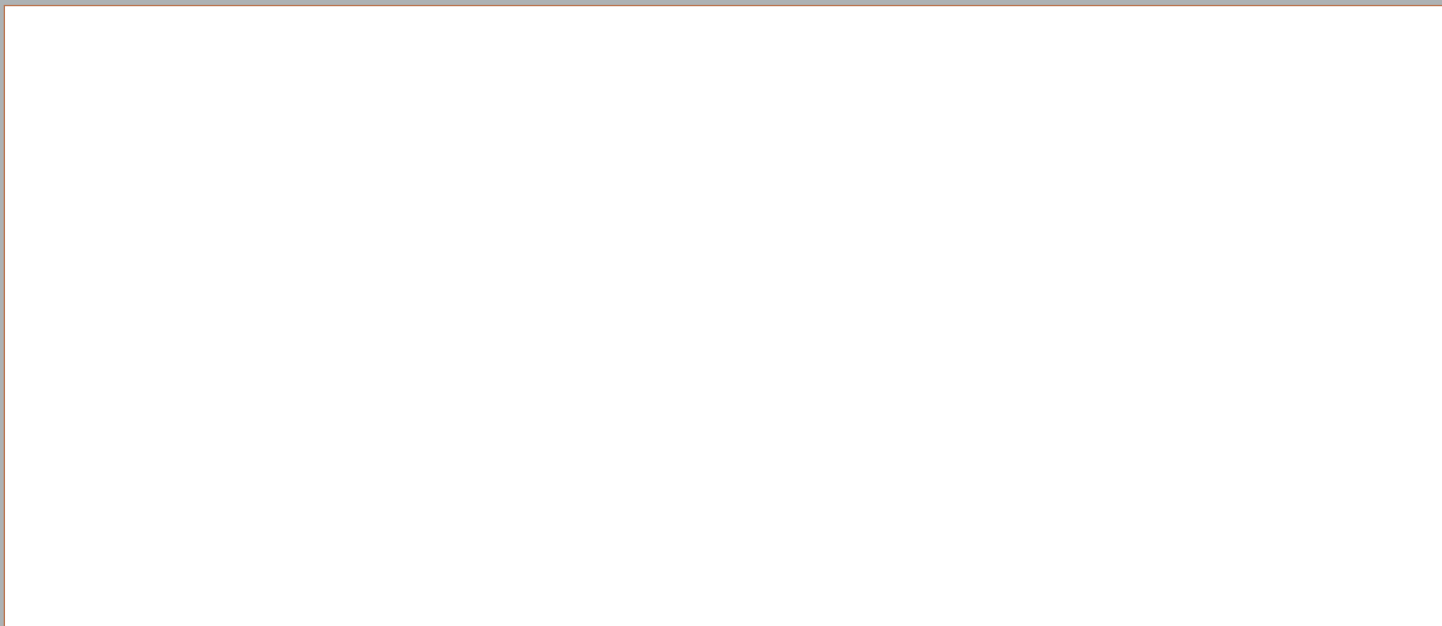

**Product Dimensions**

Length (mm):  
 Width (mm):  
 Height (mm):  
 Nett Weight (kg): 0.3

**Packaging Dimensions**

Length (mm): 125  
 Width (mm): 1100  
 Height (mm): 15  
 Gross Weight (kg): 0.3

**Packaging Data**

Box Colour:  
 Box Qty:  
 Label Size: x  
 Label Colour:  
 Label Qty:

**Outer Box Dimensions (If Applicable)**

Length (mm):  
 Width (mm):  
 Height (mm):  
 Gross Weight (kg):  
 Barcode: 5056211814313

**Product Details**

Country of Origin: United Kingdom  
 Fitting Instruction: No  
 CE Certification:  
 Colour/Finish:  
 Product Material:  
 Material Colour Reference:  
 Radius:  
 Waste Required (mm):  
 Compatible with Leg Kit:

**Sales Code:** NTP001B

**Description:** Pack Of 8 Legs/Clips & Screws

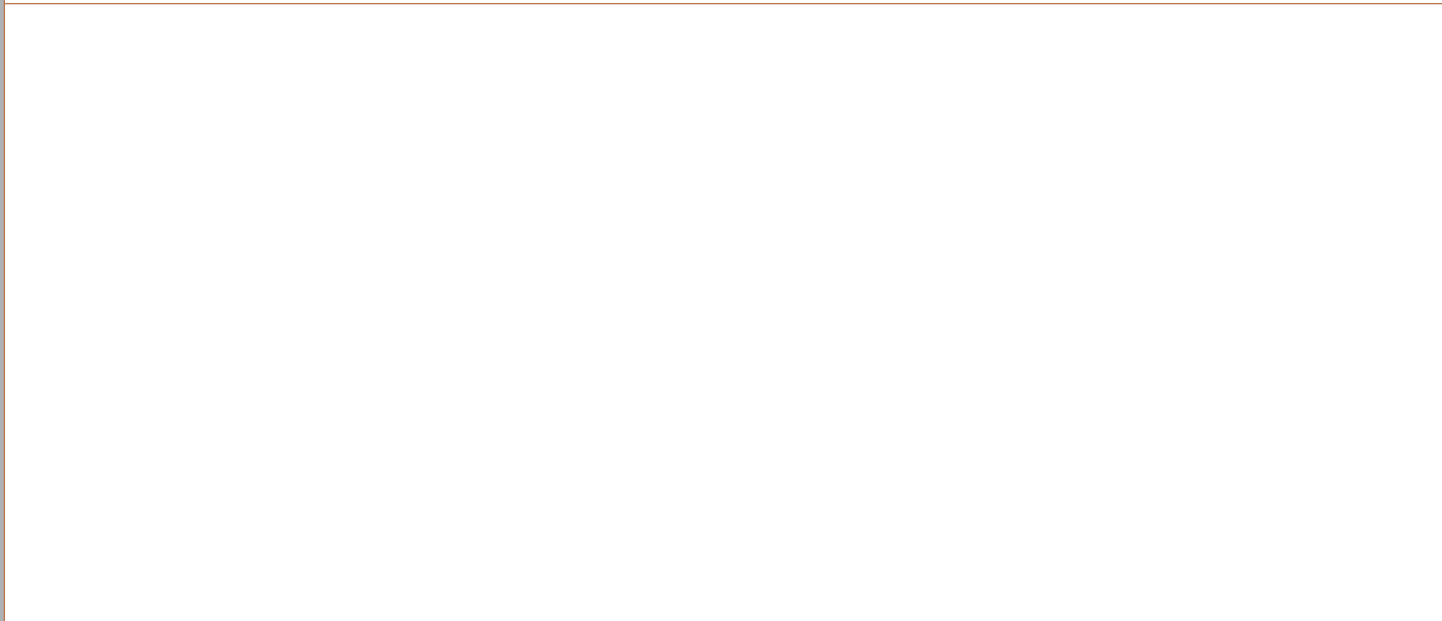
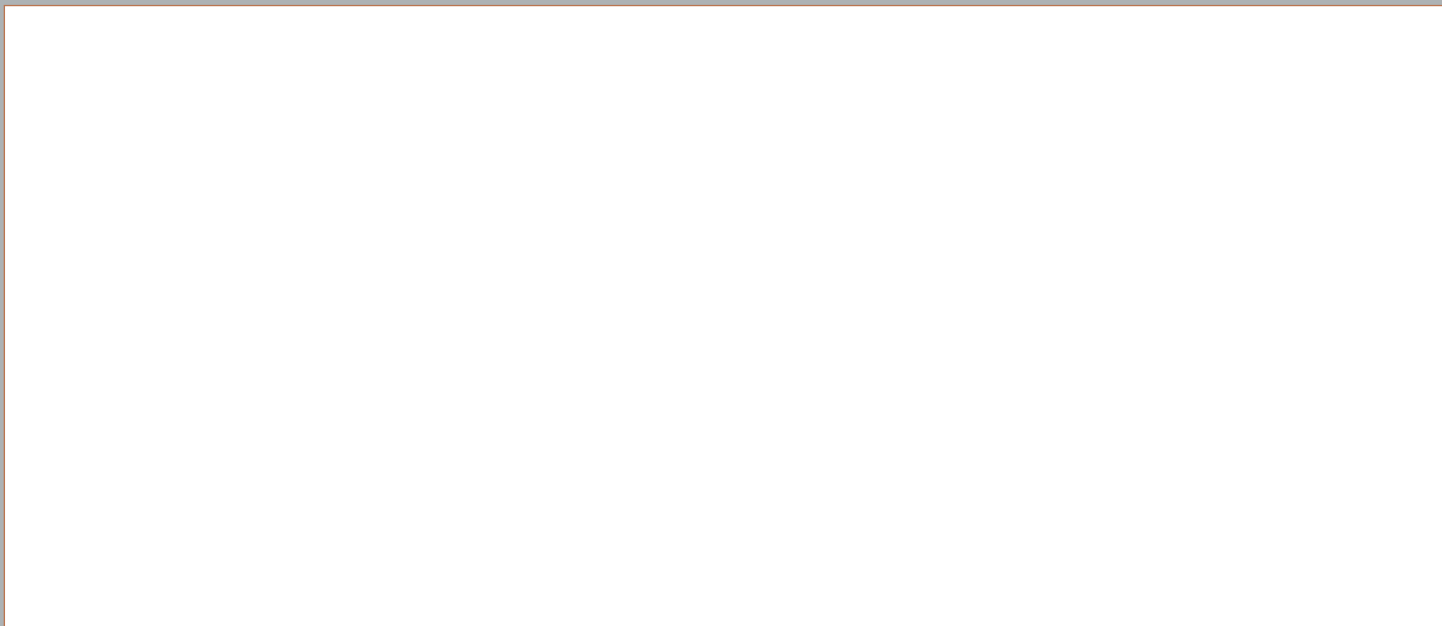

**Product Dimensions**

Length (mm):  
 Width (mm):  
 Height (mm):  
 Nett Weight (kg): 0.83

**Packaging Dimensions**

Length (mm): 180  
 Width (mm): 120  
 Height (mm): 125  
 Gross Weight (kg): 0.83

**Packaging Data**

Box Colour: Polybagged  
 Box Qty: 1  
 Label Size: 100 x 50  
 Label Colour: White Label  
 Label Qty: 2

**Outer Box Dimensions (If Applicable)**

Length (mm):  
 Width (mm):  
 Height (mm):  
 Gross Weight (kg):  
 Barcode: 5056211855422

**Product Details**

Country of Origin: China  
 Fitting Instruction: No  
 CE Certification:  
 Colour/Finish: White  
 Product Material: ABS  
 Material Colour Reference: Not Applicable  
 Radius: 0  
 Waste Required (mm):  
 Compatible with Leg Kit: Not Applicable