

SPECIFICATION SHEET

COLLECTION:

PRODUCT CODE: MIX-148D/3-C/P



DESCRIPTION:

DX Mix²
concealed 3 outlet, 2 handle thermostatic shower valve with integrated diverter
wall mounted
with rectangular backplate
thermostatic cartridge V-001C-PLA
diverter cartridge FL-804-33X/3X
2 x 3/4" female inlets
3 x 3/4" female outlets
includes 3/4" - 1/2" adaptors
inc. bleed valve for system flush on installation
min-max wall mount 70-95mm
optimum installation depth 82mm
minimum operating pressure 0.2 bar LP (shower)
minimum operating pressure 1.0 bar MP (bath)

FINISH:

Chrome

FLOW REGULATOR:

N

MINIMUM OPERATING PRESSURE:

0.2 bar LP (shower) 1.0 bar MP (bath)

FLOW RATE AT 3.0 BAR FLOW PRESSURE:

30 l/min

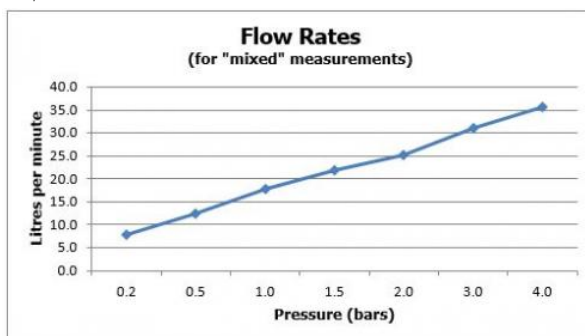

tel: 01934 744466
email: sales@vado.com
www.vado.com

where inspiration flows
taps | showering | accessories



TECHNICAL DRAWING

COLLECTION:

PRODUCT CODE: MIX-148D/3-C/P

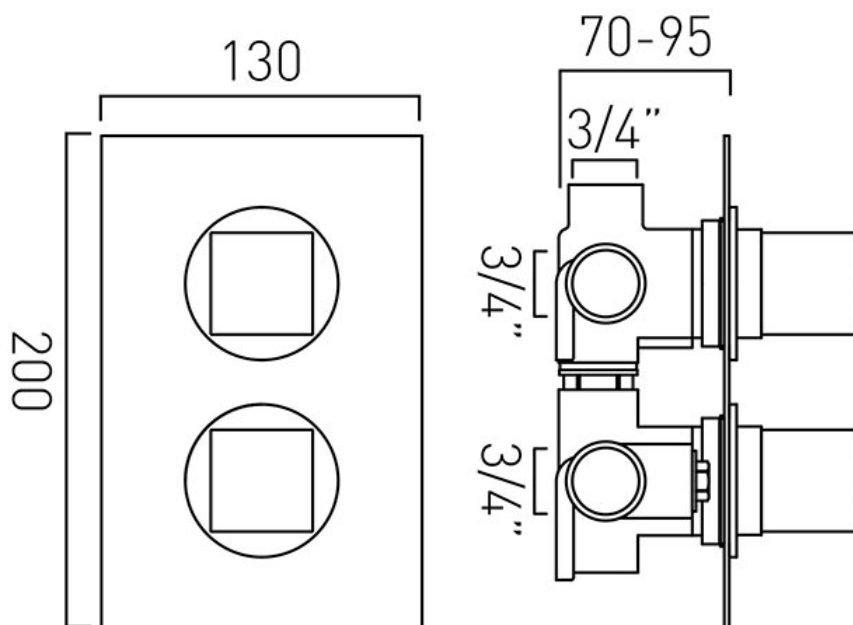

tel: 01934 744466
email: sales@vado.com
www.vado.com

where inspiration flows
taps | showering | accessories

