

DE Montageanleitung

NL Montagehandleiding

EN Mounting instruction

CS Návod k instalaci

ES Instrucciones de instalación

PL Instrukcja montażu

FR Instructions d'installation

RU Инструкция по монтажу

IT Istruzioni per l'installazione

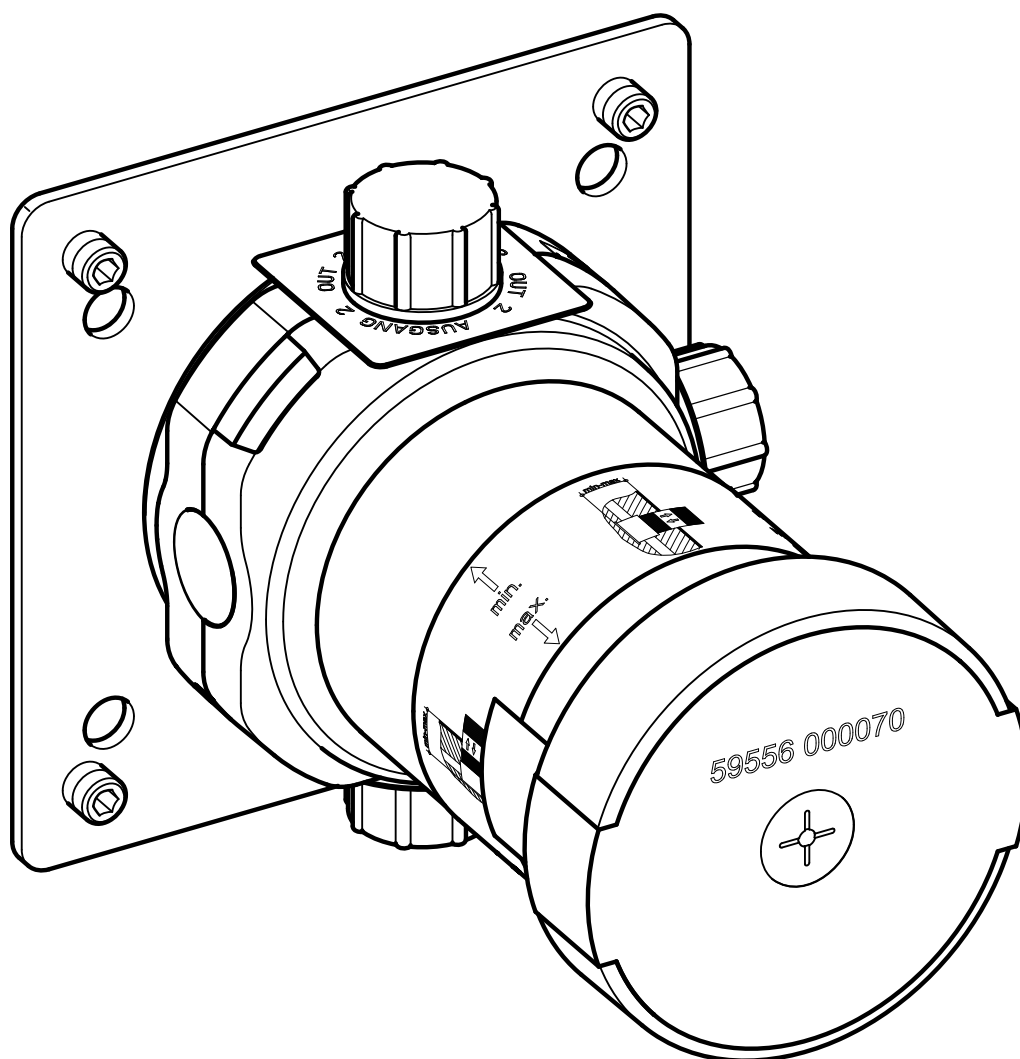

59556 000070

DE Einbaumaße

FR Dimensions de montage

CS Montážní rozměry

EN Mounting dimensions

IT Dimensioni di montaggio

PL Wymiary montażowe

ES Dimensiones de montaje

NL Montageafmetingen

RU Установочные размеры

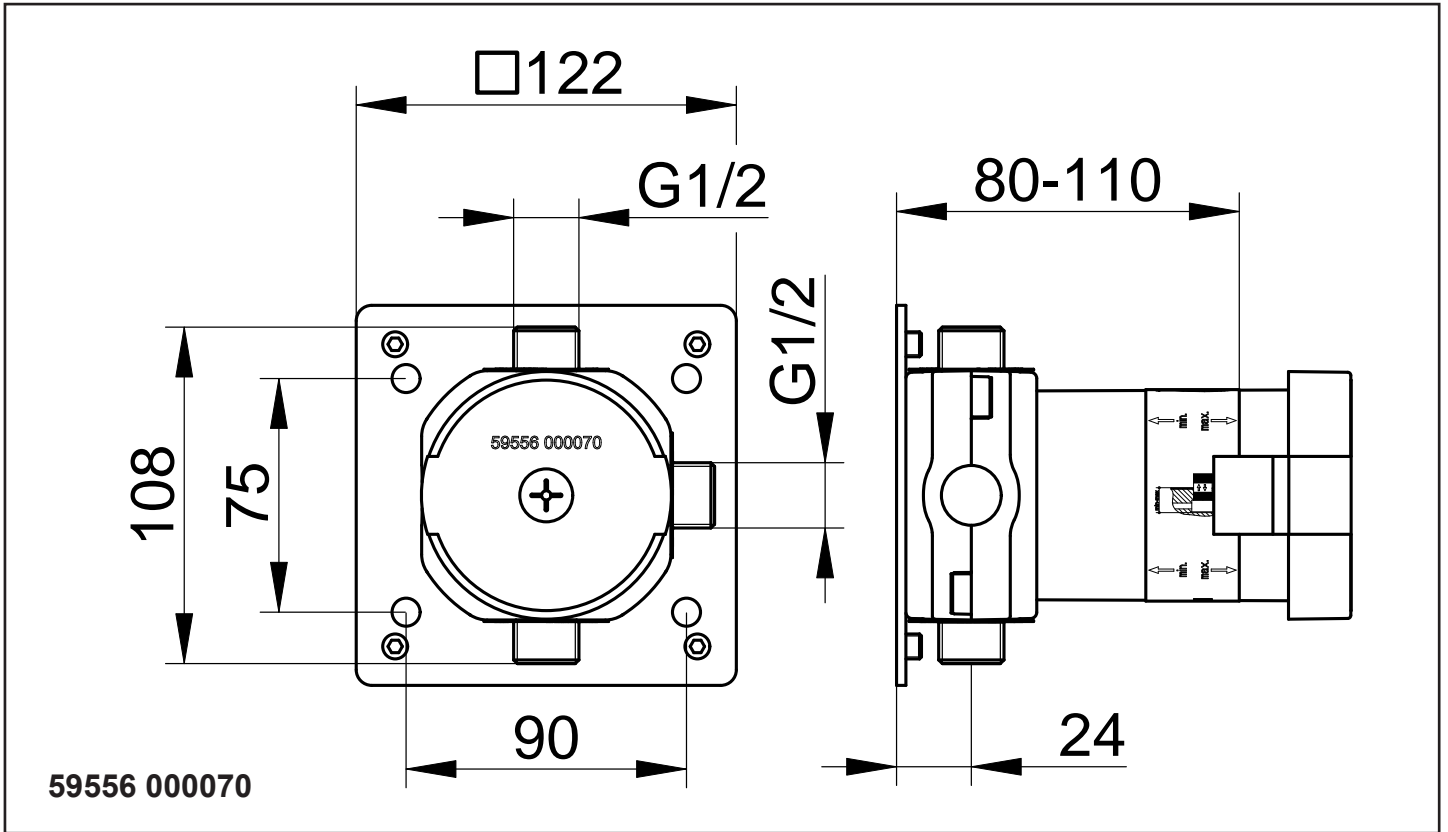

DE Kombinationen

FR Combinaisons

CS Kombinace

EN Combinations

IT Combinazioni

PL Kombinacje

ES Combinaciones

NL Combinaties

RU Комбинации

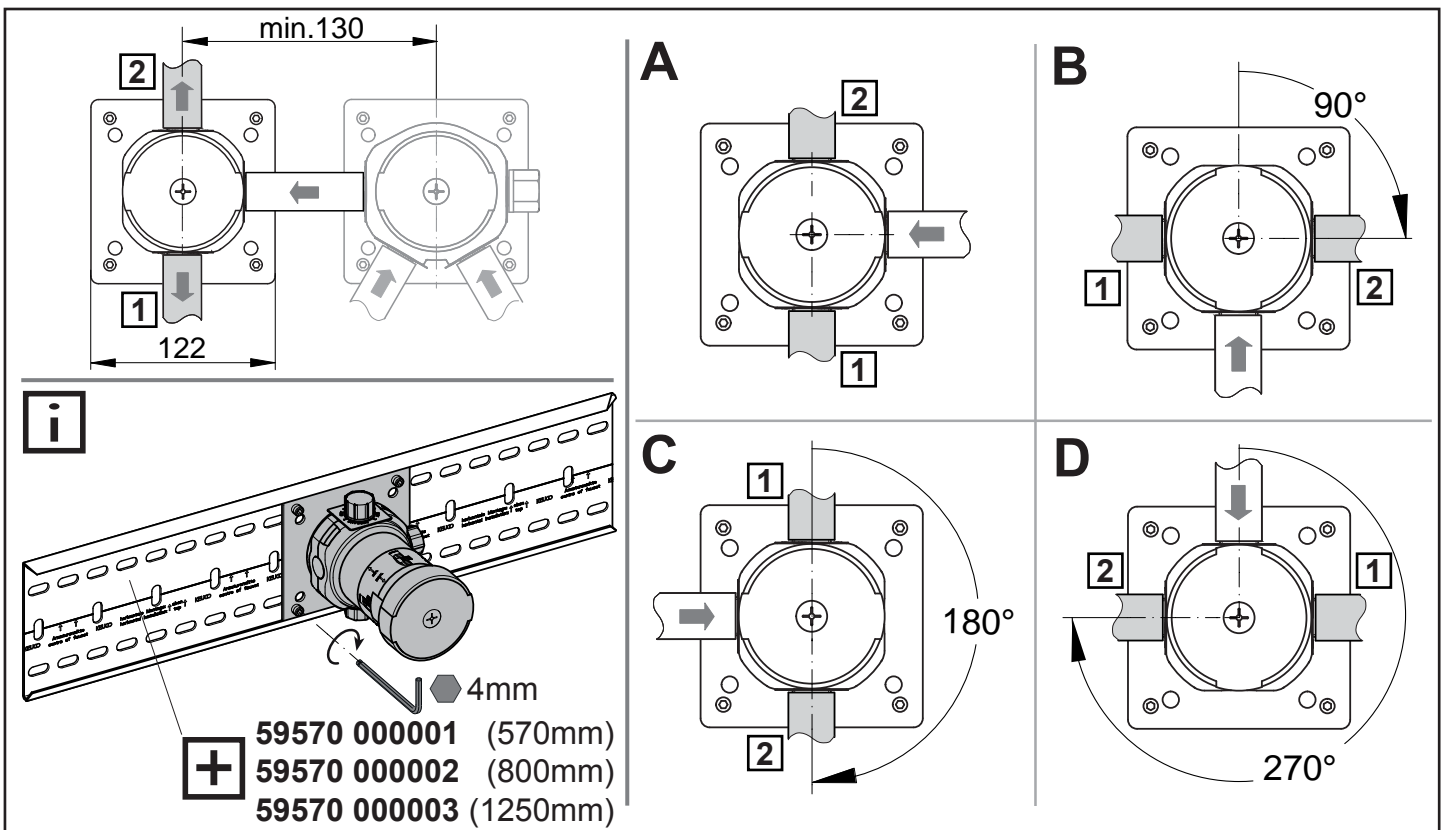

Symbole und Bedeutung





-  **Achtung!** Warnung vor Personen- oder Sachschaden.
-  **Achtung!** Warnung vor Stromschlag.
-  **Achtung!** Warnung vor Wasserschaden.
-  Hinweis, Tipp oder Verweis
-  Korrekte Montage/Funktionsprüfung
-  Falsche Montage
-  Kaltwasser
-  Warmwasser
-  Wasserfluss
-  Kein Wasserfluss
-  Optional/Zubehör

Technische Daten

- Durchfluss bei 3 bar Fließdruck: ca. 22 l/min
- Fließdruck: min. 0,5 bar/empfohlen 1-5 bar
- Betriebsdruck: max. 10 bar
- Prüfdruck: 16 bar
- Empfohlene Warmwassereingangstemperatur: max. 65° C
- Wasseranschluss: kalt = Kennzeichnung blau
warm = Kennzeichnung rot











Einbaumaße, siehe Seite 2.

Installation, siehe ab Bild 1 auf Seite 8.

-  Trinkwasserleitungen vor und nach der Installation gründlich spülen (EN 806 und 1717 sowie DIN 1988 beachten).
Anschlüsse mit hydraulischem Druck auf Dichtheit prüfen.
-  Betrieb nur mit Wasser in Trinkwasserqualität.
-  Produkt ausschließlich zur Montage in Innenräumen geeignet!
-  **Achtung!** Installation nur in frostfreien Räumen.

Ersatzteile mit Bestellnummern, siehe Seite 11.

Symbols and explanations





-  **Attention!** Warning against bodily injury or damage to property.
-  **Attention** Warning against electric shock.
-  **Attention!** Warning against water damage.
-  Note, tip or reference
-  Correct installation/test of functionality
-  Incorrect installation
-  Cold water
-  Hot water
-  Water flow
-  No water flow
-  Optional/accessories

Technical specifications

- Flow at 3 bar pressure: approx. 22 l/min
- Pressure: min. 0,5 bar/recommended 1-5 bar
- Operating pressure: max. 10 bar
- Test pressure: 16 bar
- Recommended hot water inlet temperature: max. 65° C
- Water connection: cold = blue marking
hot = red marking











Installation dimensions, refer to page 2

Installation, refer to picture 1 on page 8

-  Flush potable water pipes thoroughly before and after installation (observe EN 806 and 1717).
Test connections for leaks with water pressure.
-  Operation only with potable water.
-  Product is only suitable for installation indoors!
-  **Attention!** Only install in frost-free places.

For spare parts with order numbers, refer to page 11.

Símbolos y significado





-  ¡Atención! Advertencia de daños personales o materiales.
-  ¡Atención! Advertencia de descarga eléctrica.
-  ¡Atención! Advertencia de daños a causa del agua.
-  Indicación, consejo o referencia
-  Montaje/comprobación de funcionamiento correctos
-  Montaje erróneo
-  Agua fría
-  Agua caliente
-  Flujo de agua
-  Ningún flujo de agua
-  Opcional/Accesorios

Datos técnicos

- Paso con una presión de caudal de 3 bares:
aprox. 22 l/min.
- Presión de caudal:
mín. 0,5 bares / recomendado 1-5 bares
- Presión de servicio: máx. 10 bares
- Presión de comprobación: 16 bares
- Temperatura de entrada de agua
recomendada: máx. 65° C
- Conexión de agua:
fría = identificación azul
caliente = identificación roja











Medidas de montaje, véase página 2

Instalación, véase imagen 1 en la página 8

-  Lavar minuciosamente las tuberías de agua potable antes y después de la instalación (observar EN 806 y 1717).
Comprobar la estanqueidad de las conexiones con presión hidráulica.
-  Funcionamiento sólo con agua en calidad de agua potable.
-  ¡Producto adecuado exclusivamente para el montaje en interiores!
-  ¡Atención! Instalación exclusivamente en espacios sin riesgo de heladas.

Piezas de recambio con números de pedido, véase página 11.

Symboles et leur signification





-  **Attention !** Mise en garde contre les dégâts de personnes et les dégâts matériels.
-  **Attention !** Mise en garde contre les chocs électriques.
-  **Attention !** Mise en garde contre les endommagements par l'eau.
-  Remarque, conseil ou renvoi
-  Montage correct/contrôle fonctionnel
-  Montage incorrect
-  Eau froide
-  Eau chaude
-  Débit d'eau
-  Pas de débit d'eau
-  Option/accessoires

Caractéristiques techniques

- Débit à une pression d'écoulement de 3 bar :
env. 22 l/mn
- Pression d'écoulement :
min. 0,5 bar/pression conseillée 1-5 bar
- Pression de service : máx. 10 bar
- Pression de contrôle : 16 bar
- Température d'entrée d'eau chaude conseillée :
max. 65° C
- Raccordement d'eau :
froide = identification en bleu
chaude = identification en rouge











Cotes d'encombrement, voir page 2

Installation, voir figure 1 à la page 8

-  Rincer soigneusement les conduites d'eau potable avant et après l'installation (respecter les normes EN 806 et 1717).
Vérifier l'étanchéité des raccords à la pression hydraulique.
-  Utilisation seulement avec eau de qualité eau potable.
-  Le produit ne convient que pour un montage à l'intérieur !
-  **Attention !** Installation uniquement dans des pièces à l'abri du gel.

Pièces de rechange avec numéros de commande, voir page 11.

Simboli e significato





-  **Attenzione!** Pericolo di lesioni o danni materiali.
-  **Attenzione!** Pericolo di folgorazione.
-  **Attenzione!** Pericolo di danni causati dall'acqua.
-  Avvertenza, consiglio o rimando
-  Montaggio corretto/verifica del funzionamento
-  Montaggio errato
-  Acqua fredda  Acqua calda
-  Flusso d'acqua  Nessun flusso d'acqua
-  Opzionale/accessorio

Dati tecnici

- Portata con pressione di flusso di 3 bar:
circa 22 l/min
- Pressione di flusso:
min. 0,5 bar/raccomandati 1-5 bar
- Pressione di esercizio: max. 10 bar
- Pressione di prova: 16 bar
- Temperatura d'ingresso dell'acqua calda consigliata: max. 65°C
- Collegamento dell'acqua:
fredda = marcatura blu
calda = marcatura rossa

Ingombro, vedi pagina 2

Installazione, vedi dalla figura 1 a pagina 8

-  Prima e dopo l'installazione lavare con acqua abbondante le condotte di acqua potabile (osservare EN 806 e 1717).
Verificare la tenuta degli attacchi con pressione idraulica.
-  Funzionamento solo con acqua potabile.
-  Prodotto adatto esclusivamente per il montaggio in ambienti interni!
-  **Attenzione!** Installazione solo in ambienti in assenza di gelo.

Ricambi con numero d'ordine, vedi pagina 11.

Symbolen en betekenis





-  **Opgepast!** Gevaar voor letsel of schade.
-  **Opgepast!** Gevaar voor elektrische schok.
-  **Opgepast!** Gevaar voor waterschade.
-  Opmerking, tip of referentie
-  Correcte montage/werkingstest
-  Verkeerde montage
-  Koud water  Heet water
-  Waterstroom  Geen waterstroom
-  Optioneel/toebehoren

Technische gegevens

- Doorstroming bij 3 bar stromingsdruk:
ca. 22 l/min
- Stromingsdruk: min. 0,5 bar/aanbevolen 1-5 bar
- Bedrijfsdruk: max. 10 bar
- Testdruk: 16 bar
- Aanbevolen ingangstemperatuur heet water
max. 65° C
- Wateraansluiting:
koud = markering blauw
heet = markering rood









Inbouwafmetingen, zie pagina 2

Installatie, zie vanaf afbeelding 1 op pagina 8

-  Drinkwaterleidingen voor en na de installatie grondig spoelen (volgens EN 806 en 1717).
Aansluitingen met hydraulische druk controleren op lektheid.
-  Gebruik uitsluitend met water van drinkwaterkwaliteit.
-  Het product mag alleen binnenshuis worden gemonteerd!
-  **Opgepast!** Installatie alleen in vorstvrije ruimten.

Wisselstukken met bestelnummers, zie pagina 11.





Symbole a význam

-  **Pozor!** Výstraha před zraněním a věcnými škodami.
-  **Pozor!** Výstraha před úrazem elektrickým proudem.
-  **Pozor!** Výstraha před poškozením vodou.
-  Upozornění, tip nebo odkaz
-  Správná montáž / kontrola funkčnosti
-  Nesprávná montáž
-  Studená voda
-  Teplá voda
-  Průtok vody
-  Žádný průtok vody
-  Volitelná výbava / příslušenství

Technické údaje

- Průtok při průtokovém tlaku 3 bary:
cca. 22 l/min
- Průtokový tlak: min. 0,5 bar/doporučeno 1-5 bar
- Provozní tlak: max. 10 bar
- Zkušební tlak: 16 bar
- Doporučená teplota vstupní teplé vody:
max. 65° C
- Přípojka vody:
studená = označená modrou barvou
teplá = označená červenou barvou

Montážní rozměry viz strana 2**Instalace** viz obrázek 1 na straně 8

-  Potrubí na pitnou vodu před a po instalaci důkladně vypláchněte (postupujte podle EN 806 a 1717).
Těsnost přípojek zkontrolujte hydraulickým tlakem.
-  Provoz pouze s pitnou vodou.
-  Výrobek je vhodný výhradně k montáži ve vnitřních prostorách!
-  **Pozor!** Instalace v prostorách, které nepromrzají.

Náhradní díly s objednáacími čísly viz strany 11.





Symbole i znaczenie

-  **Uwaga!** Ostrzeżenie przed szkodami osobowymi i materialnymi.
-  **Uwaga!** Ostrzeżenie przed porażeniem prądem elektrycznym.
-  **Uwaga!** Ostrzeżenie przed szkodami, spowodowanymi przez wodę.
-  Informacja, dobra rada lub odsyłacz
-  Właściwy montaż / kontrola funkcjonowania
-  Niewłaściwy montaż
-  Woda zimna
-  Woda gorąca
-  Strumień wody
-  Brak strumienia wody
-  Opcje / Osprzęt

Dane techniczne

- Przepływ w przypadku ciśnienia hydraulicznego 3 bar:
około 22 l/min
- Ciśnienie hydrauliczne:
min. 0,5 bar/zalecane 1-5 bar
- Ciśnienie robocze: maks. 10 bar
- Ciśnienie kontrolne: 16 bar
- Zalecana temperatura wody gorącej na wejściu:
maks. 65° C
- Przyłącze wody:
zimna = oznaczenie niebieskie
gorąca = oznaczenie czerwone

Wymiary zabudowy, patrz strona 2**Instalacja**, patrz rys. 1 na stronie 8

-  Przed instalacją i po instalacji należy gruntownie przepłukać przewody, prowadzące wodę pitną (należy stosować się do EN 806 i 1717).
Sprawdzić przyłącza ciśnieniem hydraulicznym w celu potwierdzenia ich szczelności.
-  Możliwa eksploatacja w instalacji wody, zapewniającej jakość typową dla wody pitnej.
-  Produkt przeznaczony jest wyłącznie do montażu wewnątrz budynków!
-  **Uwaga!** Instalacja wyłącznie w pomieszczeniach, w których temperatura nie spada poniżej zera.

Części zamienne z numerami zamówienia, patrz strona 11.

Символы и их значение





-  **Внимание!** Опасность физического и материального ущерба.
-  **Внимание!** Опасность поражения электрическим током.
-  **Внимание!** Опасность ущерба вследствие воздействия воды.
-  Указание, совет или ссылка
-  Правильный монтаж / проверка работоспособности
-  Неправильный монтаж
-  Холодная вода
-  Горячая вода
-  Водный поток
-  Нет водного потока
-  Опция/принадлежность

Технические характеристики

- Пропускная способность при давлении потока в 3 бар: около 22 л/мин
- Давление потока: мин. 0,5 бар/рекомендуется 1-5 бар
- Рабочее давление: макс. 10 бар.
- Расчетное давление: 16 бар.
- Рекомендуемая входная температура горячей воды: макс. 65° С
- Подключение воды:
холодная = маркировка синим
горячая = маркировка красным

Монтажные размеры, см. стр. 2

Установка, см. рис. 1 на стр. 8

-  Водопроводы питьевой воды до и после установки тщательно промыть (EN 806 и 1717).
Проверьте соединения с гидравлическим давлением на герметичность.
-  Использовать только воду питьевого качества.
-  Изделие предназначено исключительно для монтажа внутри помещения!
-  **Внимание!** Устанавливать только в непромерзающих помещениях.

Запасные части с номерами для заказа, см. стр. 11.

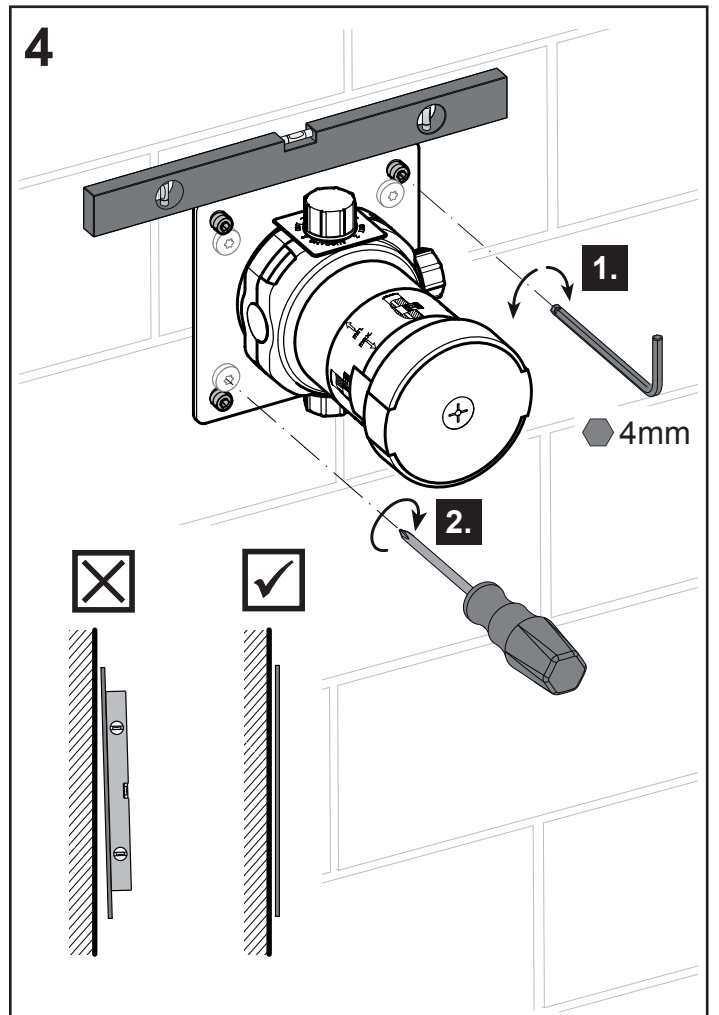
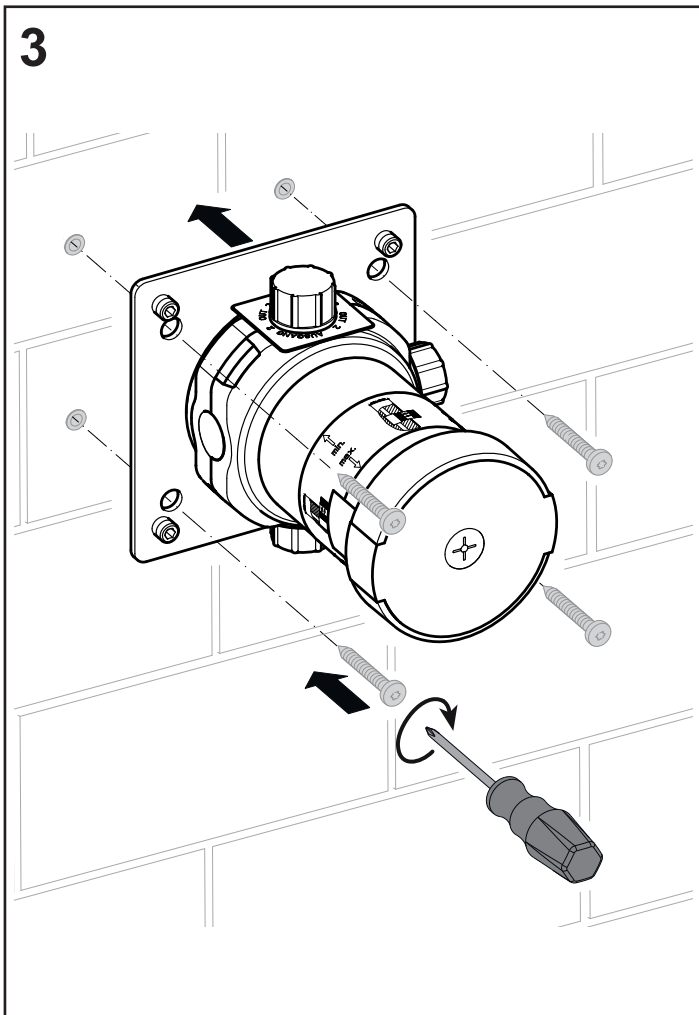
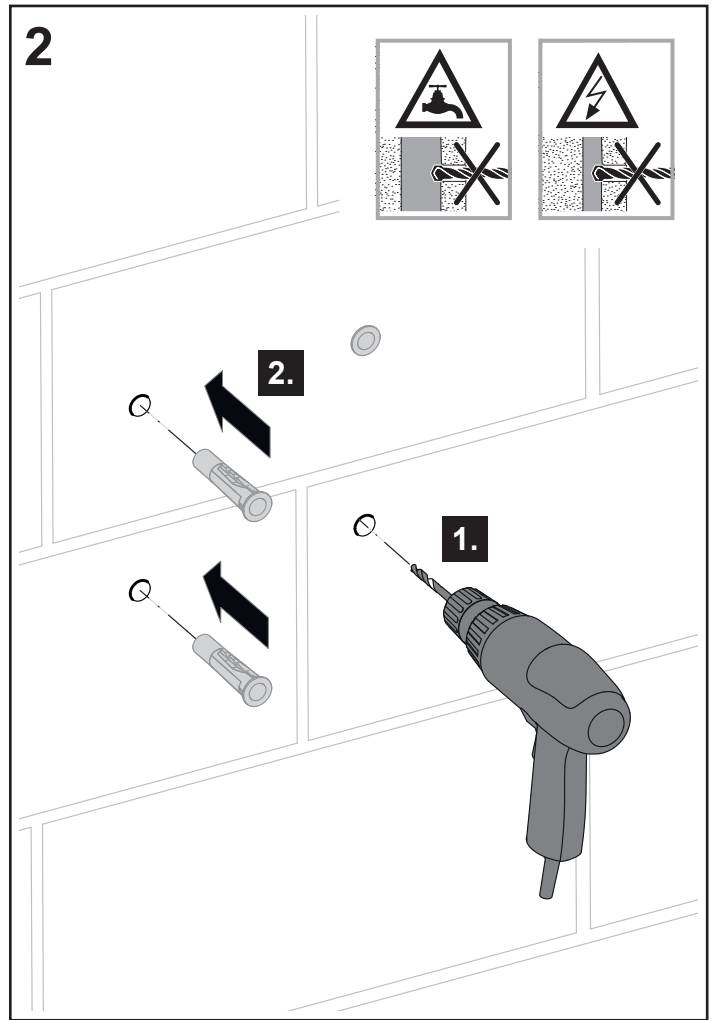
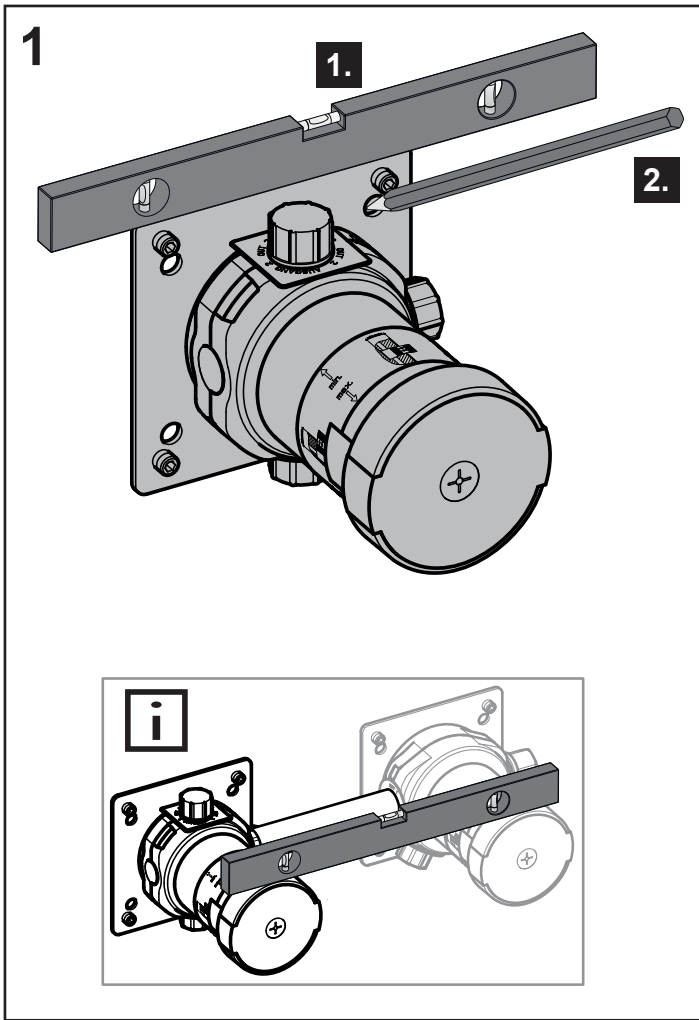

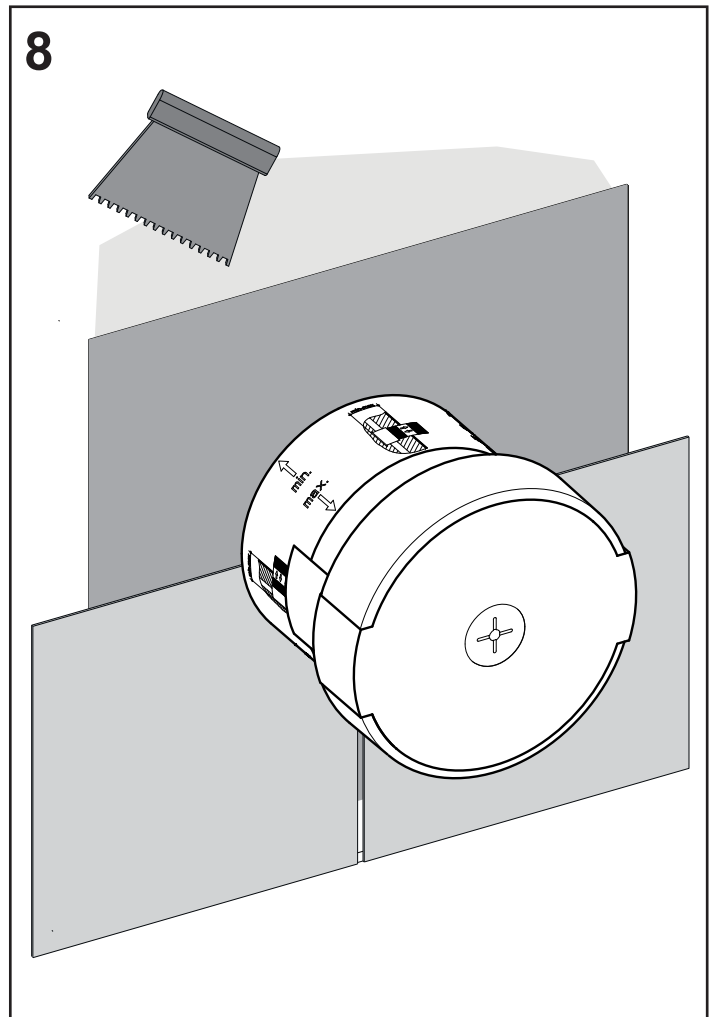
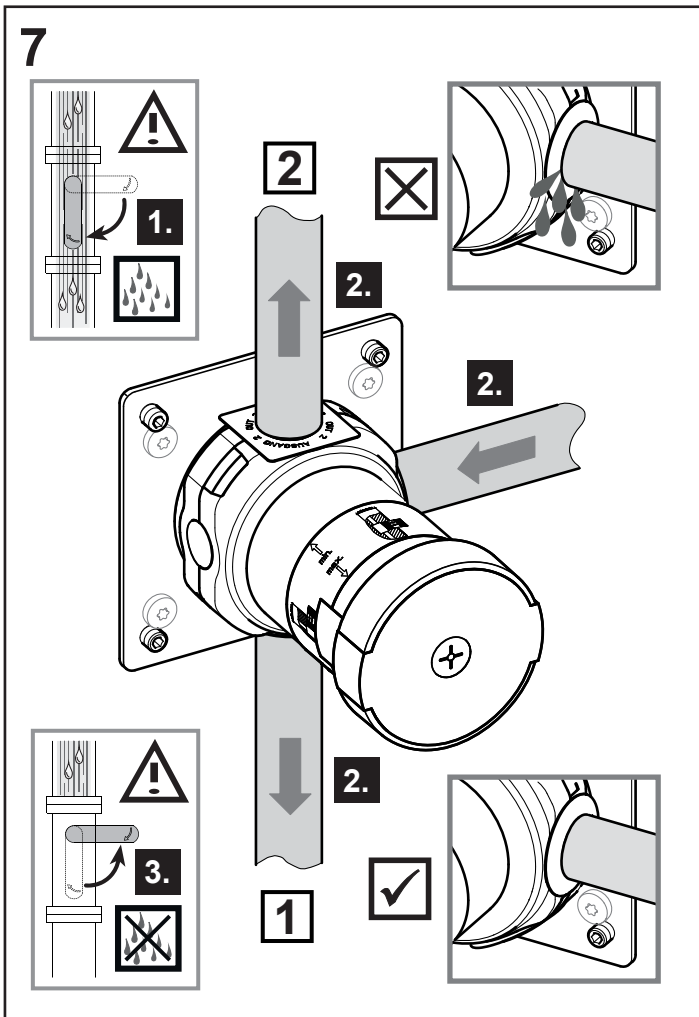
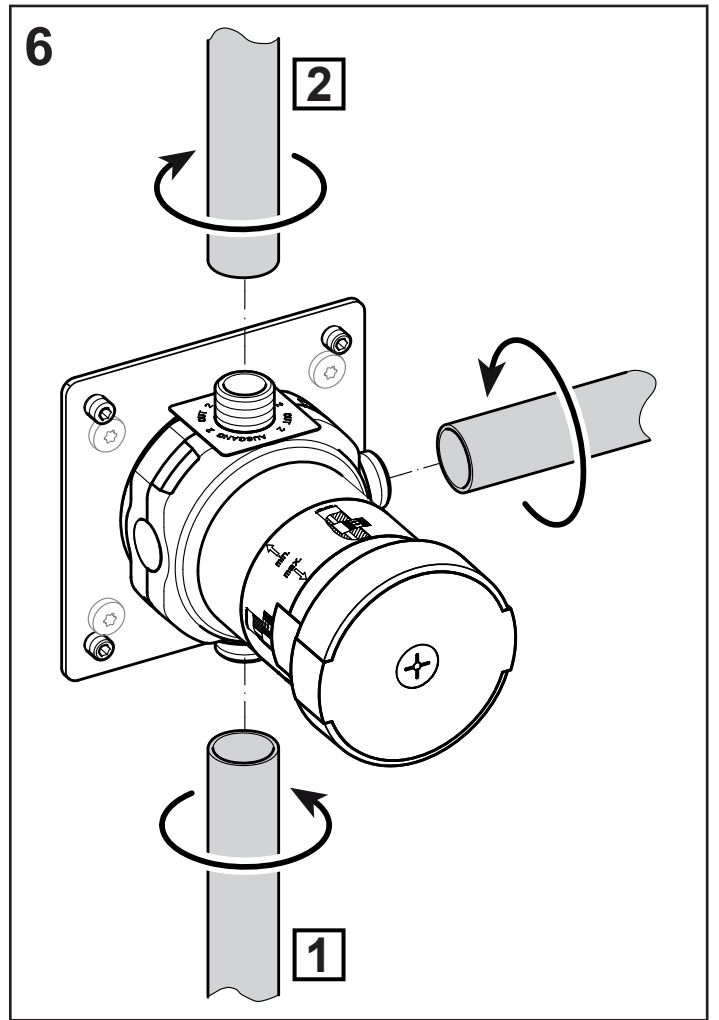
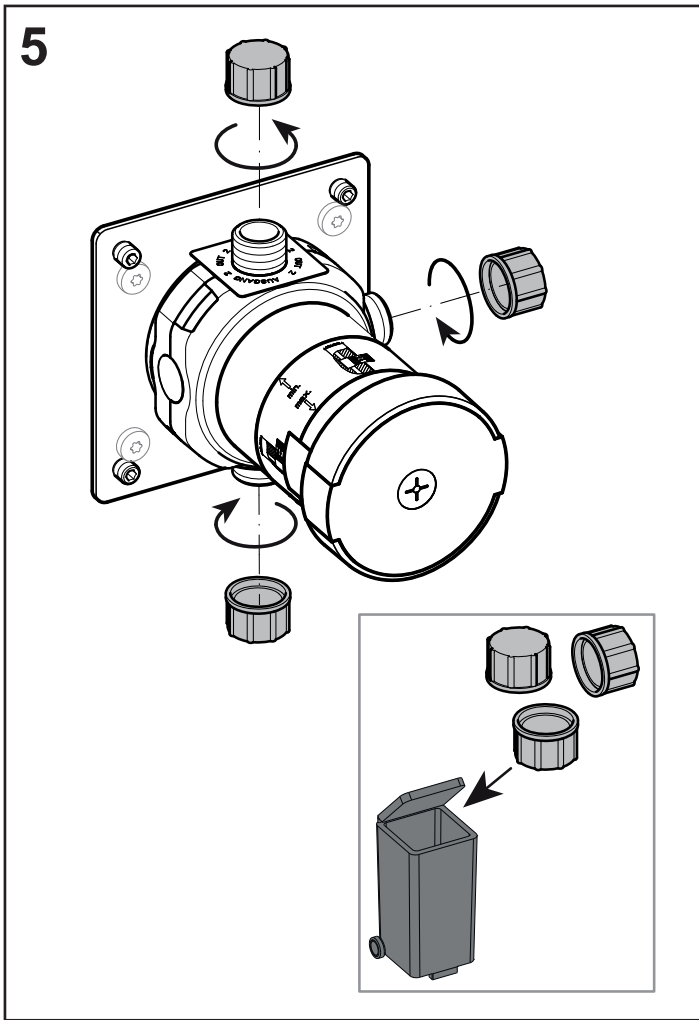



A series of 20 horizontal lines for writing, spaced evenly down the page.

DE Ersatzteile
EN Spare parts
ES Piezas de recambio

FR Liste de pièces
IT Elenco delle parti
NL Onderdelen

CS Sada náhradních
PL Zestaw części
RU Запчасти

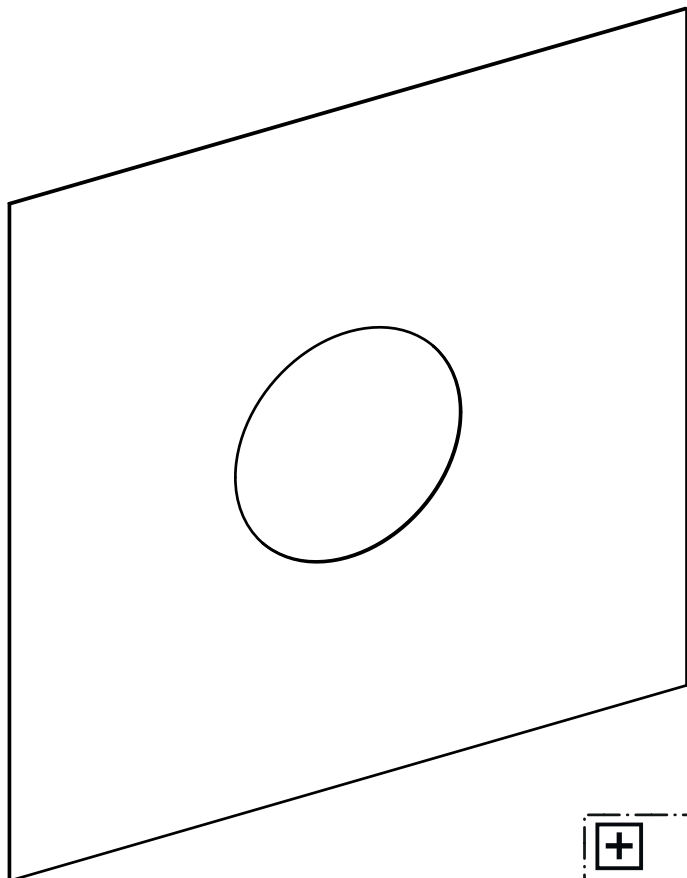
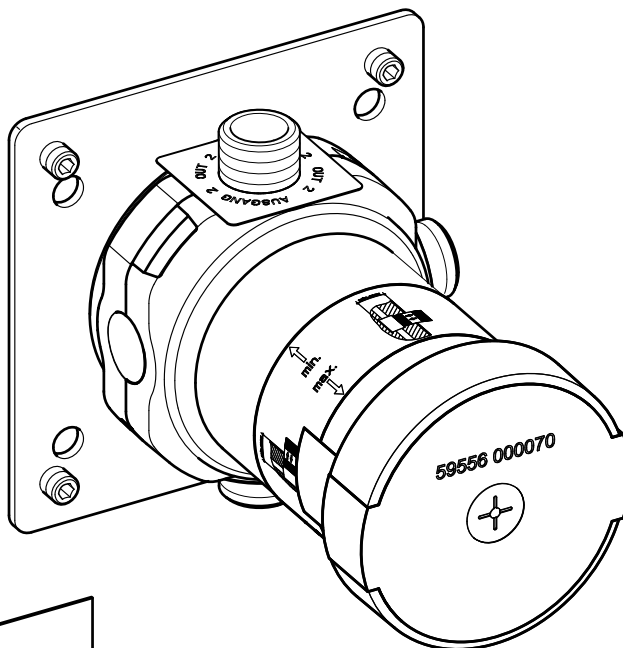

50100000499

59570000001 (570mm)
59570000002 (800mm)
59570000003 (1250mm)

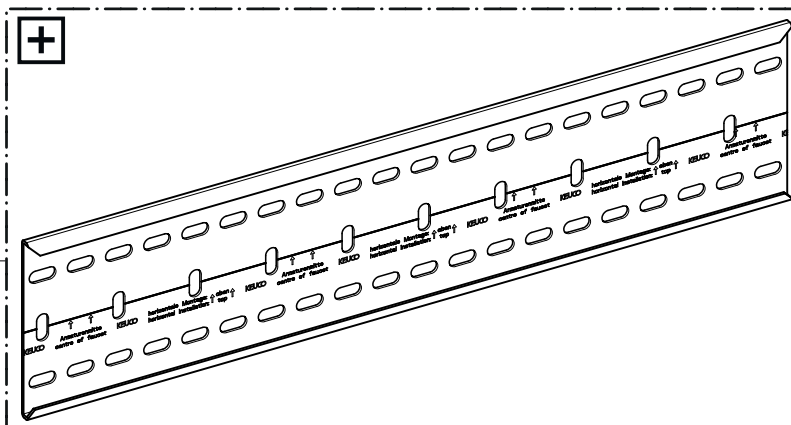

59556 000070

