

# Concept 170cm x 70cm Idealform Plus+ Bath No Tapholes

## ILLUSTRATED

- E8600** Concept 170 x 70cm Idealform plus+ bath with no tapholes
- B9929** Concept bath filler 2 hole dual control
- E4797** Unilux Plus+ 170cm front panel for Idealform Plus+
- E4831** Unilux Plus+ 70cm end panel
- S8970** Trap 1½" plastic P with 75mm seal, multi-purpose outlet suitable for plastic and BS copper pipe
- E5795** Waste 1½" bath pop-up waste and overflow components only
- E5800** Bath pop-up waste operating handle and cover only
- A5901** TMV Thermostatic mixing valve 22mm

## OPTIONS

- A4053** Active dual control two hole thermostatic bath filler

## ILLUSTRATED PRODUCT DETAILS









### Weights

- E8600** 20.70 KG
- B9929** 2.64 KG
- E4797** 3.65 KG
- E4831** 2.58 KG
- S8970** 1.00 KG
- E5795** 1.34 KG
- E5800** 0.82 KG
- A5901** 1.70 KG

### Materials

- E8600** Idealform Plus+
- B9929** Chrome Plated Brass
- E4797** Acrylic
- E4831** Acrylic
- S8970** Plastic
- E5795** Chrome Plated Metal
- E5800** Chrome Plated Metal
- A5901** Chrome Plated Metal

### Finishes

- E8600**  White (01)
- B9929**  Chrome (AA)
- E4797**  White (01)
- E4831**  White (01)
- S8970**  Neutral / No Finish (67)
- E5795**  Neutral / No Finish (67)
- E5800**  Chrome (AA)
- A5901**  Chrome (AA)

### Capacity

- E8600** 174 litres (to overflow)

### Flow rates

- B9929** 80 Litres per minute @ 3 bar pressure

### Designer

Robin Levien, RDI

### Standards

Constructed to EN 198:2008

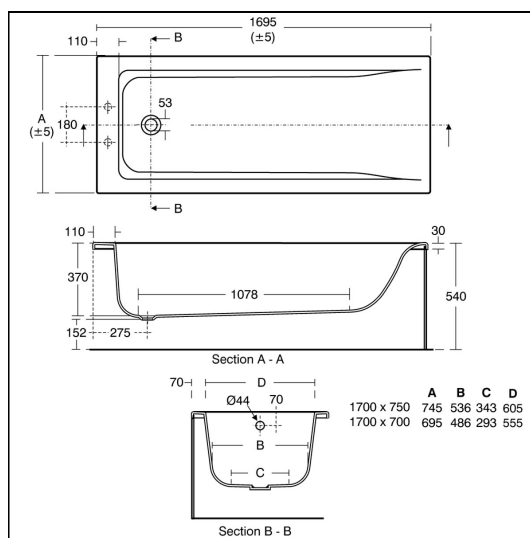

## ACCREDITATIONS



## FEATURES

