

Simplicity Steel bath 160x70cm 2 Tapholes With Handgrips & Anti-slip*

ILLUSTRATED

- E8186** Simplicity bath 160 x 70cm standard gauge steel, chrome plated grips two tapholes, anti-slip*
- B9674** Alto dual control two hole bath filler
- S8970** Trap 1½" plastic P with 75mm seal, multi-purpose outlet suitable for plastic and BS copper pipe
- S8840** 1 1/2" Combination bath waste & trap with overflow and domed clicker
- A5901** TMV Thermostatic mixing valve 22mm

OPTIONS

- B9675** Alto dual control two hole bath shower mixer with shower set
- S0915** Bath flat front panel
- S0916** Bath flat end panel
- S9365** Bath panel plastic corner edge strip
- S8830** Waste 1½" bath chain and overflow, plastic plug

ILLUSTRATED PRODUCT DETAILS





Weights

- E8186** 25.05 KG
- B9674** 2.31 KG
- S8970** 1.00 KG
- S8840** 0.31 KG
- A5901** 1.70 KG

Materials

- E8186** Porcelain Enamelled Steel
- B9674** Chrome Plated Brass
- S8970** Plastic
- S8840** Plastic
- A5901** Chrome Plated Metal

Finishes

- E8186**  White (01)
- B9674**  Chrome (AA)
- S8970**  Neutral / No Finish (67)
- S8840**  Chrome (AA)
- A5901**  Chrome (AA)

Capacity

- E8186** 150 litres (to overflow)

Standards

Manufactured to BS 1344-3:1998
Standard gauge 2mm porcelain enamelled steel

Special Notes

*Note, Anti-slip reduces the likelihood of slipping but it does not prevent all slipping. Care to be taken when cleaning as aggressive products may reduce the effectiveness of the slip resistant area. Consideration should be given to safe hot water delivery and the use of an appropriate temperature reduction device see A5901AA or Part G for guidance.

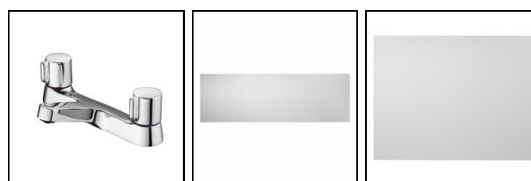
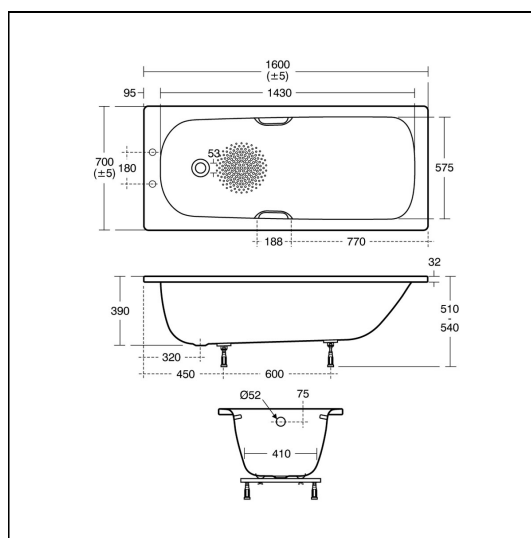

FEATURES

