

Concept 170cm x 70cm Idealform Bath 2 Tapholes

ILLUSTRATED

- E7292** Concept 170 x 70cm Idealform bath with 2 tapholes
- A4053** Active dual control two hole thermostatic bath filler
- E3194** Unilux 170cm front panel
- E3169** Unilux 70cm end panel
- E5795** Waste 1½" bath pop-up waste and overflow components only
- E5800** Bath pop-up waste operating handle and cover only

ILLUSTRATED PRODUCT DETAILS







Weights

- E7292** 20.70 KG
- A4053** 4.50 KG
- E3194** 3.65 KG
- E3169** 2.58 KG
- E5795** 1.34 KG
- E5800** 0.82 KG

Materials

- E7292** Idealform
- A4053** Chrome Plated Brass
- E3194** Acrylic
- E3169** Acrylic
- E5795** Chrome Plated Metal
- E5800** Chrome Plated Metal

Finishes

- E7292**  White (01)
- A4053**  Chrome (AA)
- E3194**  White (01)
- E3169**  White (01)
- E5795**  Neutral / No Finish (67)
- E5800**  Chrome (AA)

Capacity

- E7292** 174 litres (to overflow)

Flow rates

- A4053** 13 Litres per minute @ 3 bar pressure

Designer

Robin Levien, RDI

Standards

Constructed to EN 198:2008. EN 14516

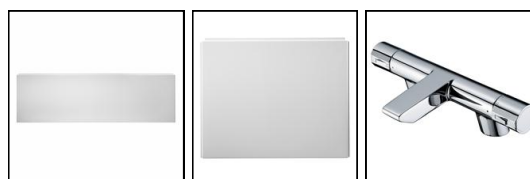
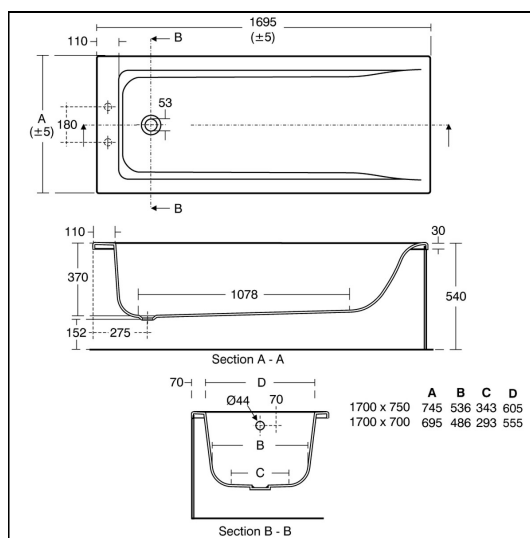

ACCREDITATIONS

E7292(01)

A4053(AA)

FEATURES

