

Concept Air 150 x 80cm Idealform Shower Bath RH

ILLUSTRATED

- E1544** Concept Air 150 x 80cm Idealform shower bath right hand with no taphole
- E1551** Concept Air 150cm shower bath front panel
- S8970** Trap 1½" plastic P with 75mm seal, multi-purpose outlet suitable for plastic and BS copper pipe
- E5795** Waste 1½" bath pop-up waste and overflow components only
- E5800** Bath pop-up waste operating handle and cover only
- E1085** Concept Air shower bath screen with access panel

OPTIONS

- E3169** Unilux 70cm end panel
- A5901** TMV Thermostatic mixing valve 22mm

ILLUSTRATED PRODUCT DETAILS







Weights

- E1544** 23.90 KG
- E1551** 3.10 KG
- S8970** 1.00 KG
- E5795** 1.34 KG
- E5800** 0.82 KG

Materials

- E1544** Idealform
- E1551** Acrylic
- S8970** Plastic
- E5795** Chrome Plated Metal
- E5800** Chrome Plated Metal
- E1085** Toughened Safety Glass

Finishes

- E1544**  White (01)
- E1551**  White (01)
- S8970**  Neutral / No Finish (67)
- E5795**  Neutral / No Finish (67)
- E5800**  Chrome (AA)
- E1085**  Bright Silver (EO)

Capacity

- E1544** 170 litres (to overflow)

Designer

Robin Levien, RDI

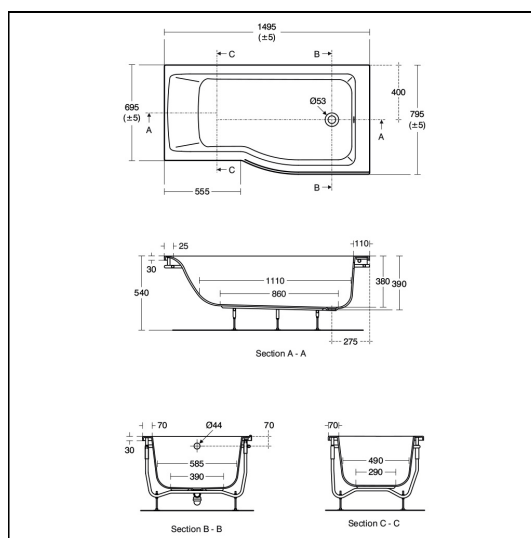

Standards

Constructed to EN 198:2008. EN 14513

Special Notes

Consideration should be given to safe hot water delivery and the use of an appropriate temperature reduction device see A5901AA or Part G for guidance. One tap hole fittings require offsetting from the overflow. Check positioning and compatibility before specifying.