

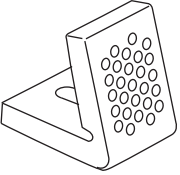

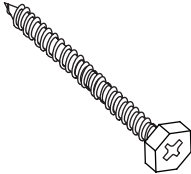
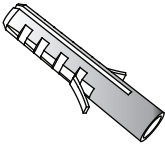
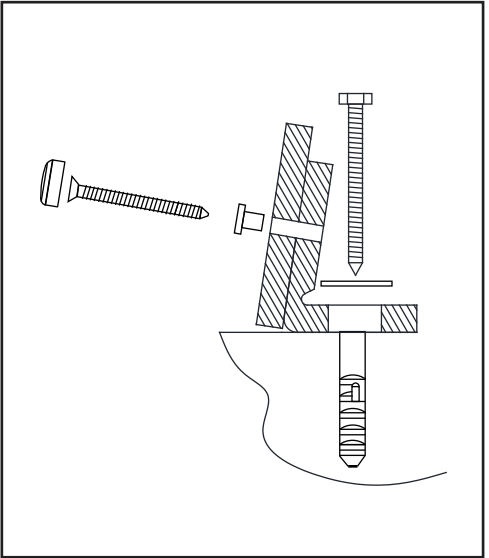

PARTS SUPPLIED:

Check to make sure that all these parts are included in the package:

			
L bracket 2x	Hex head screw 2x	Wall plug 2x	
			
Screw 2x	Washer 2x	Chrome cap 2x	Plastic insert 2x

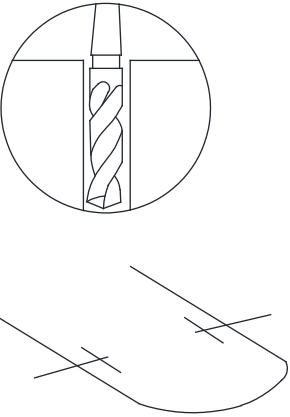

1. Place the product into position and mark the location of the fixing holes required.
 2. Remove the product and drill 10mm holes using a suitable drill bit.

3. Secure the L bracket using the side with the single hole and tighten to the wall/floor.

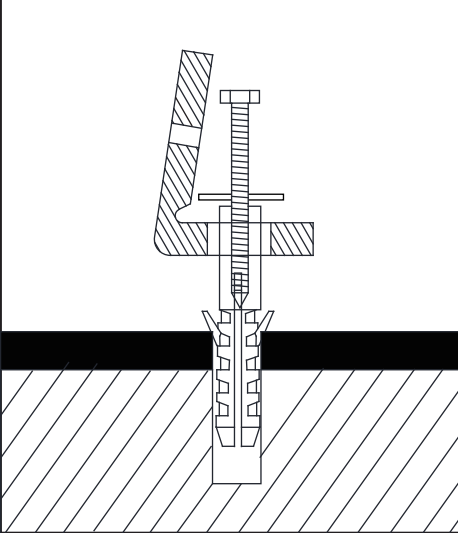
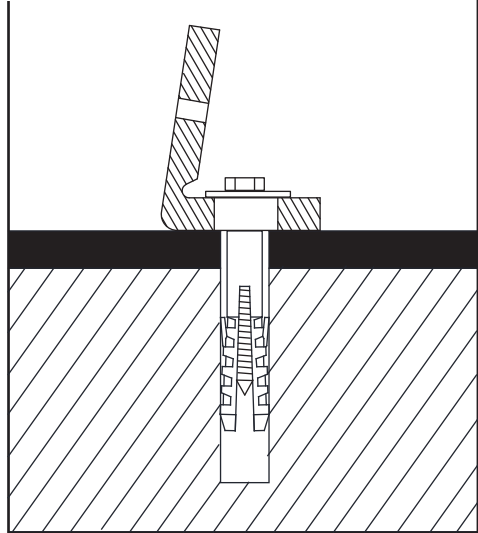
4. Re-locate the product.

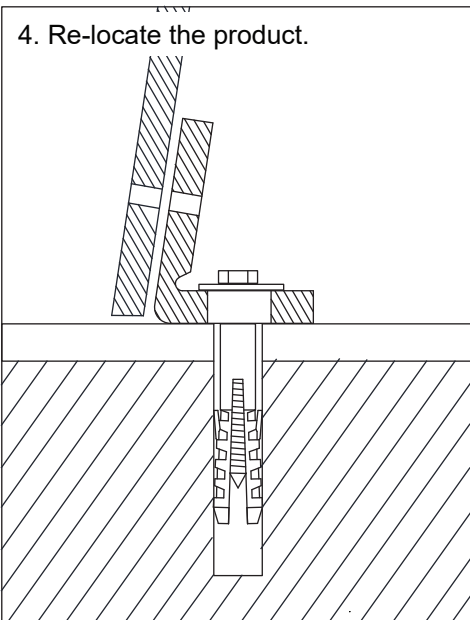

5. Secure into the L bracket, ensure the grommet for the screw cap is fitted to the screw before fitting and once tight connect the cover cap to finish.

