

Care Plus Manual Washbasin Bracket, Vertical and Horizontal Adjustment

ILLUSTRATED

- S0653** Care Plus washbasin mounting bracket, manually operated, vertical and horizontal adjustment
- S0656** Care Plus track 60cm length
- S2252** Portman 21 washbasin 50cm, 1 taphole, no overflow or chainstay hole
- S8803** Waste 1¼" Click plug waste, 80mm slotted tail
- A6698** Contour 21+ 1 hole thermostatic basin mixer, single sequential lever with flexible tails
- S0650** Care Plus flexible 120cm feed and 150cm waste system for sideways adjustment

ILLUSTRATED PRODUCT DETAILS

Sizes

S2252 w:50 x d:42







Weights

- S0653** 23.82 KG
- S0656** 2.10 KG
- S2252** 12.73 KG
- S8803** 1.00 KG
- A6698** 2.10 KG
- S0650** 1.70 KG

Materials

- S0653** Mixed Material
- S0656** Aluminium
- S2252** Vitreous China
- S8803** Chrome Plated Metal
- A6698** Chrome Plated Brass
- S0650** Mixed Material

Finishes

- S0653**  Neutral / No Finish (67)
- S0656**  Neutral / No Finish (67)
- S2252**  White (01)
- S8803**  Chrome (AA)
- A6698**  Chrome (AA)
- S0650**  Neutral / No Finish (67)

Flow rates

A6698 3.9 Litres per minute @ 3 bar pressure

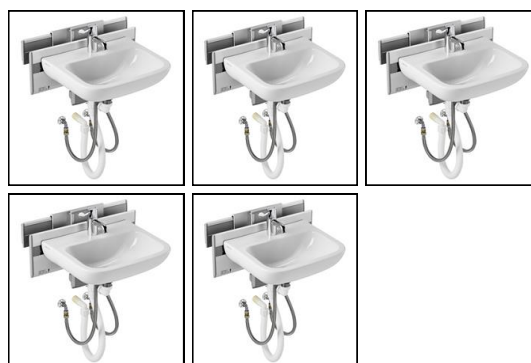
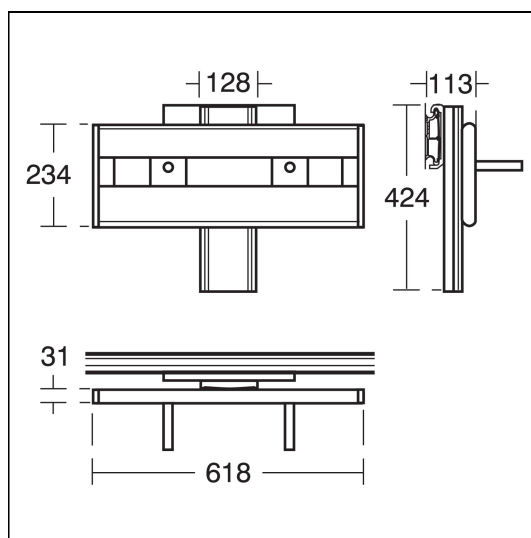

FEATURES

