

WASHINGTON TAPS
2 Outlet | Thermostatic Valve

RAK
CERAMICS

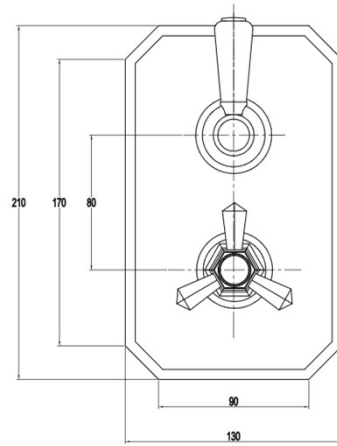

Dimensions: 130w x 0d x 210h mm

Colour: CHROME

Code: RAKWTN3202

Pressures: 0.5 BAR – 6.0 BAR

Warranty: 15 YEARS

Weight: 3.60 KG

Dimensions: All Dimensions in mm tolerance $\pm 5\%$ for below 200mm and $\pm 3\%$ for above 200mm.
Note: Due to a continuing development programme to improve design and performance the manufacturer reserves all rights to vary specifications without prior information.
Please note accessories are for photographic use only.