

Oleas M3 mechanical dual flushplate

ILLUSTRATED

R0123 Oleas M3 mechanical dual flushplate Ideal Standard - chrome

OPTIONS

- R0140** ProSys 820mm height, mechanical wall hung WC frame, 150 depth, front or top actuation
- R0153** ProSys 1150mm height, mechanical wall hung WC frame, 120 depth, front actuation
- R0101** ProSys freestanding half frame for wall hung WC pans (no cistern)
- R0142** ProSys 150 depth wc cistern, mechanical front or top actuation
- R0317** ProSys 120 depth WC cistern, mechanical, front actuation

ILLUSTRATED PRODUCT DETAILS

Weights

R0123 0.34 KG

Finishes

R0123  White (AC)

Materials

R0123 Mixed Material

Designer

Robin Levien, RDI

FINISH OPTIONS



(AC) White



(AA) Chrome



(JG) Brushed Chrome



(A6) Black

Special Notes

For use with ProSys mechanical actuation WC frames and cisterns.

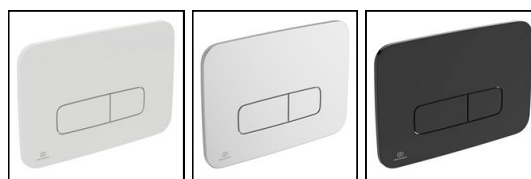
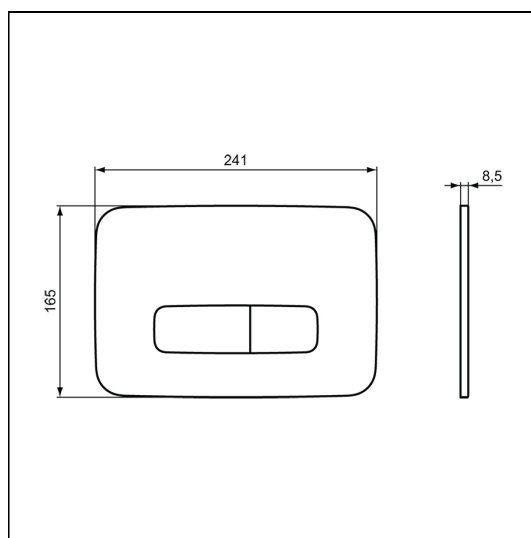

FEATURES

