

Sales Code: NLT91006

Description: Square Shower Tray 800X800

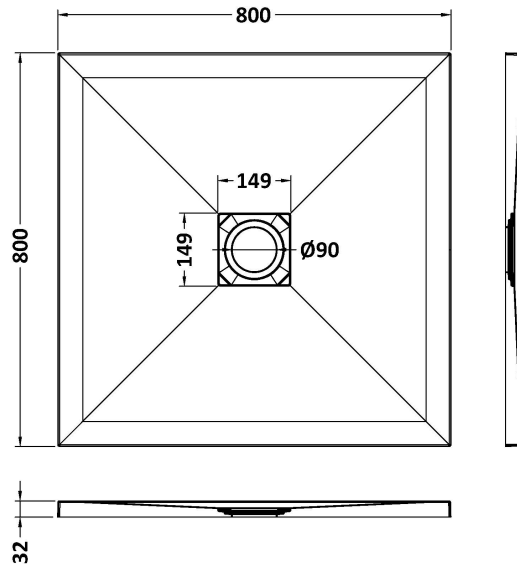

Product Dimensions

| | |
|-------------------|-------|
| Length (mm): | 800 |
| Width (mm): | 800 |
| Height (mm): | 33 |
| Nett Weight (kg): | 24.73 |

Packaging Dimensions

| | |
|--------------------|-------|
| Length (mm): | 840 |
| Width (mm): | 840 |
| Height (mm): | 73 |
| Gross Weight (kg): | 24.73 |

Packaging Data

| | |
|---------------|--------------------------|
| Box Colour: | Shrinkwrap & Polystyrene |
| Box Qty: | 1 |
| Label Size: | 100 x 50 |
| Label Colour: | White Label |
| Label Qty: | 2 |

Outer Box Dimensions (If Applicable)

| | |
|--------------------|---------------|
| Length (mm): | |
| Width (mm): | |
| Height (mm): | |
| Gross Weight (kg): | |
| Barcode: | 5056462656199 |

Product Details

| | |
|----------------------------|-------------------------------|
| Country of Origin: | United Kingdom |
| Fitting Instruction: | No |
| CE Certification: | Yes |
| Colour/Finish: | Slate Black |
| Product Material: | Acrylic Capped ABS Caco3 & Pu |
| Material Colour Reference: | Slate Black |
| Radius: | 0 |
| Waste Required (mm): | 90 |
| Compatible with Leg Kit: | No |