

Sales Code: LQ502

Description: 700X500 Led Mirror

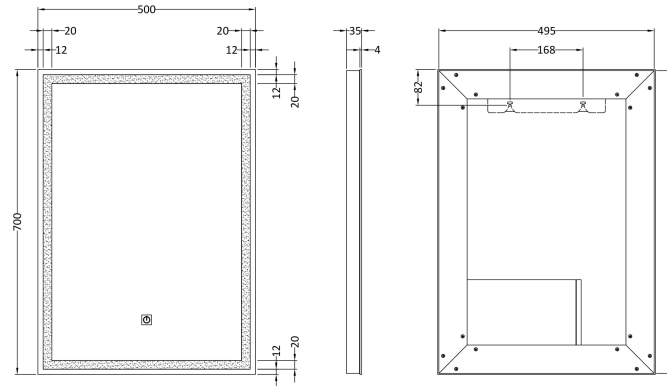

Product Dimensions

Height (mm):	700
Width (mm):	500
Depth (mm):	35
Nett Weight (kg):	5

Packaging Dimensions

Height (mm):	830
Width (mm):	625
Depth (mm):	90
Gross Weight (kg):	7

Packaging Data

Box Colour:	Brown Cardboard Box - Printed
Box Qty:	1
Label Size:	x
Label Colour:	Not Applicable
Label Qty:	

Outer Box Dimensions (If Applicable)

Height (mm):	
Width (mm):	
Depth (mm):	
Gross Weight (kg):	
Barcode:	5056211890614

Product Details

Country of Origin:	China
Fitting Instruction:	No
Certification:	CE: Yes FSC: No WEEE: Yes RoHS: Yes
	EMC: Yes LYD: Yes ECOMP: ECIRC:

Product Material:	Aluminium
Colour/Finish:	
No of Shelves:	0
Fixings Included:	Yes
Light Power Source:	Mains Supply
No of Lights:	1
Bulb Type:	Led
Voltage:	12
Operation Method:	Touch Sensor
Bulb Watt:	26
Product Features:	Demister
Illuminated:	Yes