

Sales Code: RLF1700M1

Description: 1700 Freestanding Shower Bath Deacon Leg



Packaging Details

Barcode: 5056211851967

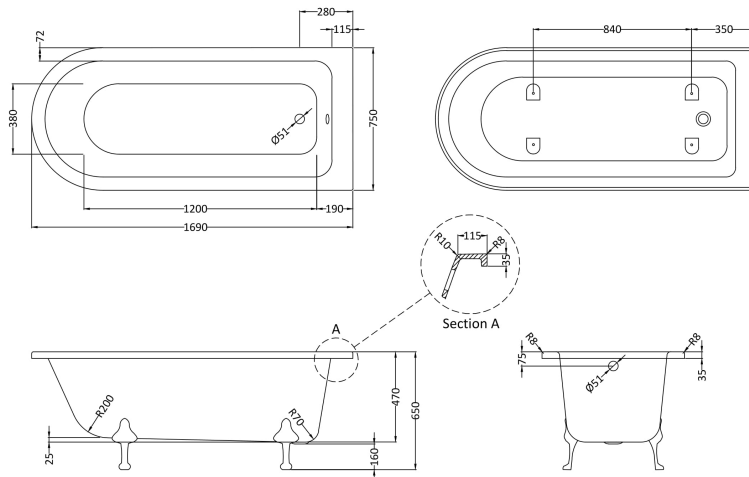

Sales Code: RLF1700

Description: 1700 Freestanding Shower Bath

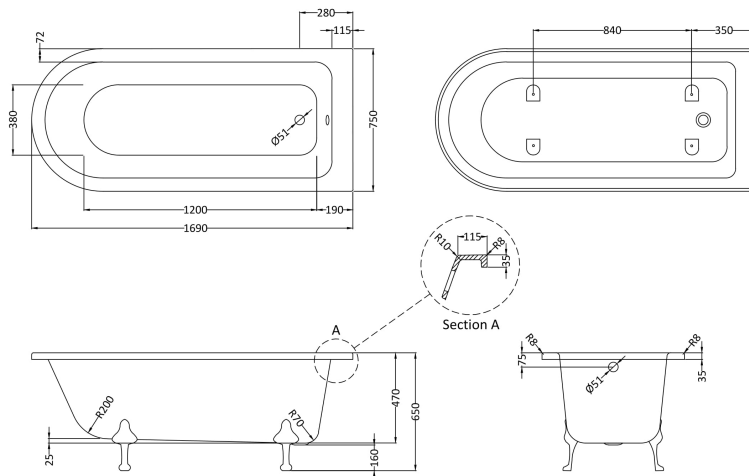

Product Dimensions

Length (mm):	1690
Width (mm):	750
Depth (mm):	650
Nett Weight (kg):	47.5

Packaging Dimensions

Length (mm):	1690
Width (mm):	750
Depth (mm):	500
Gross Weight (kg):	47.5

Packaging Data

Box Colour:	
Box Qty:	
Label Size:	x
Label Colour:	
Label Qty:	

Outer Box Dimensions (If Applicable)

Length (mm):	
Width (mm):	
Height (mm):	
Gross Weight (kg):	
Barcode:	5056211804963

Product Details

Country of Origin:	Singapore
Fitting Instruction:	No
Certification:	FSC: CE:
Material Colour Reference:	European White
Product Material:	Acrylic
Material Thickness:	12mm
Volume (Ltr):	210
Displaced Capacity:	170
Leg Set Included:	Legset Not Included
Waste Included:	Waste Not Included
Drilled/Undrilled:	Undrilled For Taps
Includes Grips:	No Grips Supplied
Embossed:	No
No of Tapholes:	None
Anti-Slip:	No

Sales Code: M1C

Description: Deacon F/Standing Bath Leg Set M1

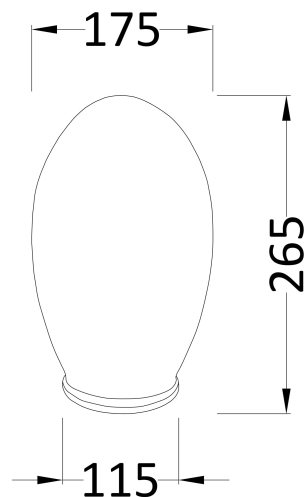

Product Dimensions

Length (mm):	260
Width (mm):	500
Depth (mm):	250
Nett Weight (kg):	5.4

Packaging Dimensions

Length (mm):	470
Width (mm):	455
Depth (mm):	230
Gross Weight (kg):	5.77

Packaging Data

Box Colour:	Polystyrene Moulded Box
Box Qty:	1
Label Size:	140 x 100
Label Colour:	White Label
Label Qty:	1

Outer Box Dimensions (If Applicable)

Length (mm):	
Width (mm):	
Height (mm):	
Gross Weight (kg):	
Barcode:	5055369044818

Product Details

Country of Origin:	China
Fitting Instruction:	No
Certification:	FSC: N/A CE: N/A
Material Colour Reference:	Not Applicable
Product Material:	Aluminium
Material Thickness:	N/A
Volume (Ltr):	N/A
Displaced Capacity:	N/A
Leg Set Included:	Not Applicable
Waste Included:	Not Applicable
Drilled/Undrilled:	Not Applicable
Includes Grips:	Not Applicable
Embossed:	Not Applicable
No of Tapholes:	Not Applicable
Anti-Slip:	Not Applicable