

Sales Code: NBV159

Description: Vessel 615 X 355 X 155

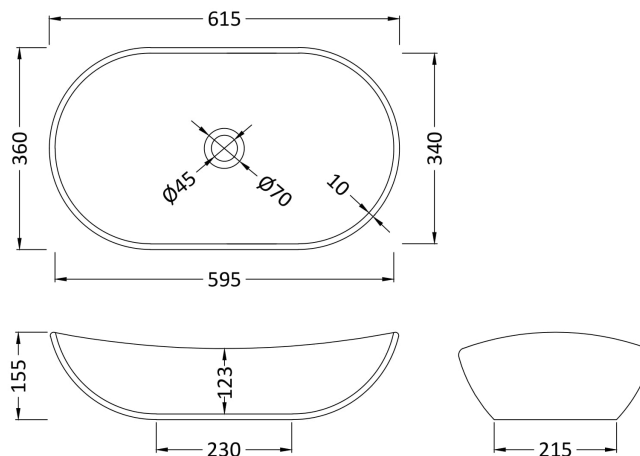

Product Dimensions

Height (mm):	155
Width (mm):	615
Depth (mm):	355
Nett Weight (kg):	8.7

Packaging Dimensions

Height (mm):	175
Width (mm):	380
Depth (mm):	630
Gross Weight (kg):	9.6

Packaging Data

Box Colour:	Brown Cardboard Box
Box Qty:	1
Label Size:	100 x 50
Label Colour:	White Label
Label Qty:	2

Outer Box Dimensions (If Applicable)

Height (mm):	
Width (mm):	
Depth (mm):	
Gross Weight (kg):	
Barcode:	5055275890585

Product Details

Country of Origin:	China
Fitting Instruction:	No
Certification:	CE: WRAS: WRAS No:
Product Material:	Vitreous China
Fixing Supplied:	Not Applicable

Pans/Bidets: Trap Style: Not Applicable Includes Seat: Not Applicable

Seats: Seat Type: Not Applicable Material: Not Applicable
 Function: Not Applicable Hinge Type: Not Applicable
 Hinge Material: Not Applicable

Cisterns: Operating Type: Not Applicable Fittings: Not Applicable
 Lever Type: Not Applicable

Basins: Tap Hole: No Tapholes Chain Stay Hole: No
 Template: Not Required Waste Type Req: Not Applicable
 Overflow Inc: No Overflow Cover: No
 Inner Bowl Depth (mm): 138mm