

# ASSEMBLY GUIDE

## SIDE PANEL

### Tools Required (not supplied)

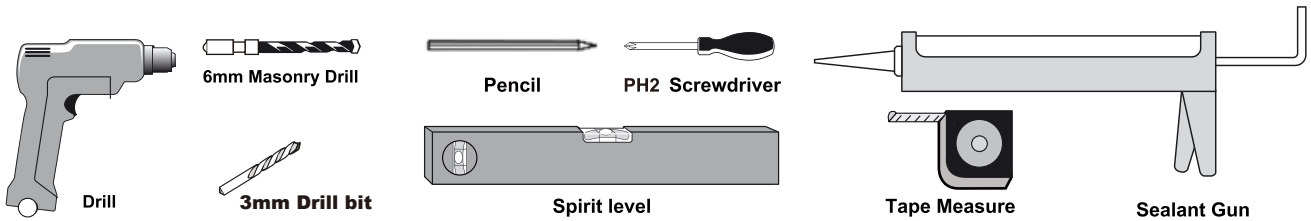

**Note:** Instruction shows fitting of a Side panel with a Pivot door as an example only. This Side panel can fit with the Sliding door, Bi-fold door, and Hinge door etc.

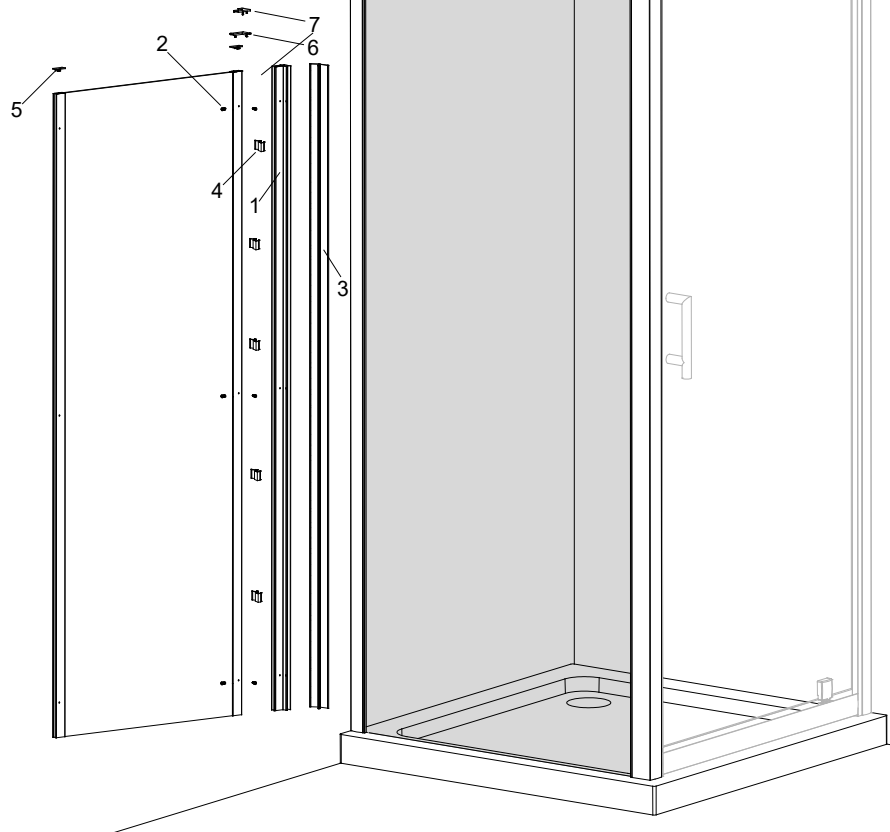

Item	Description	Image	Qty
1	Corner Post		1
2	Screw ST4x12		3
3	Cover Strip		1
4	Cover Clip		5
5	Upright Profile Cap		2
6	Corner Profile Cap - LH		1
7	Corner Profile Cap - RH		1

### ASSEMBLY INSTRUCTIONS      IMPORTANT PLEASE READ

The cubicle can be constructed either way up, for left or right hand opening.

These instructions and list of parts assume that installation is done against solid/tiled walls.

Please check this product for damage prior to starting the installation. No claims can be made after the product has been fitted.

PLEASE NOTE :The minimum and maximum adjustment sizes noted on the product brochures are based on perfectly plumb walls and trays.

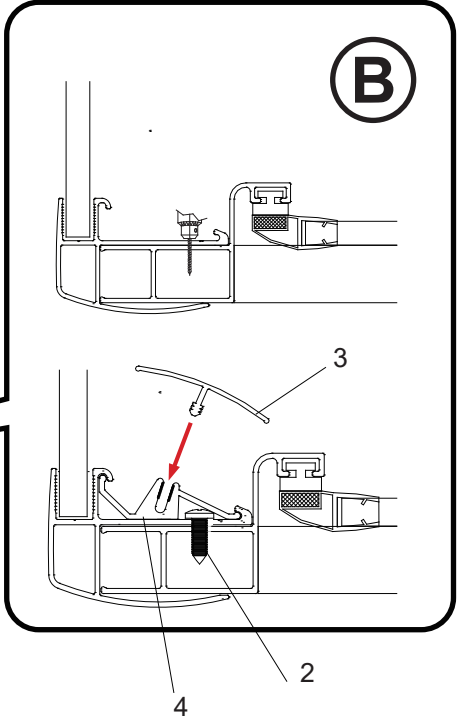
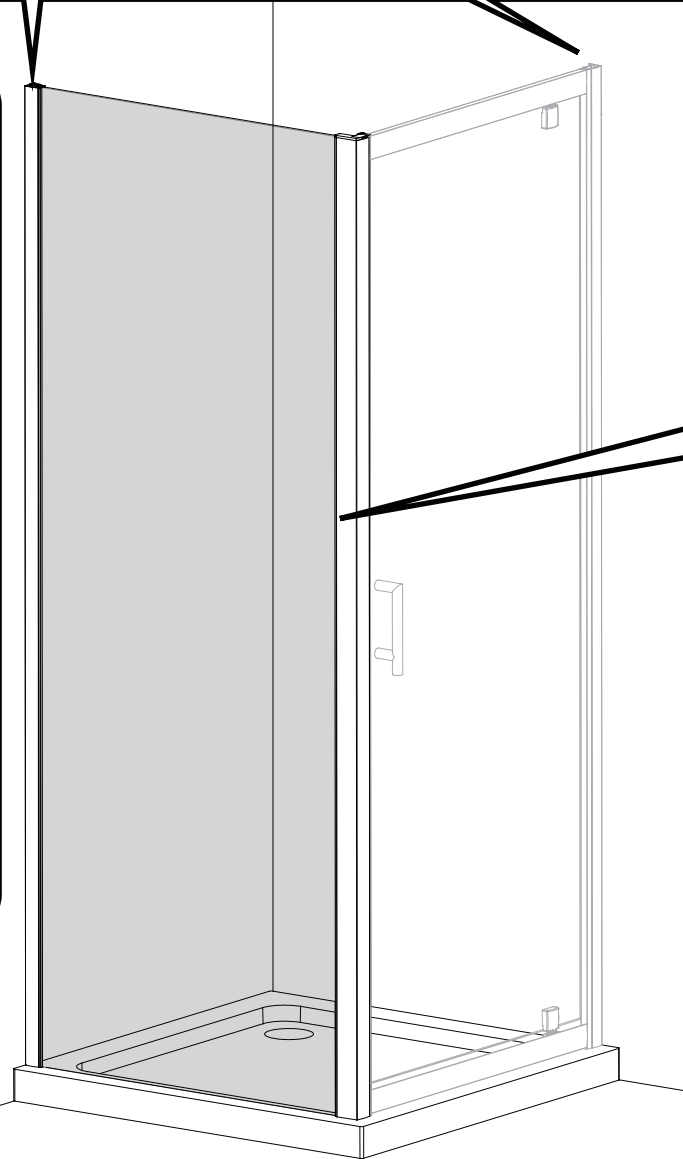
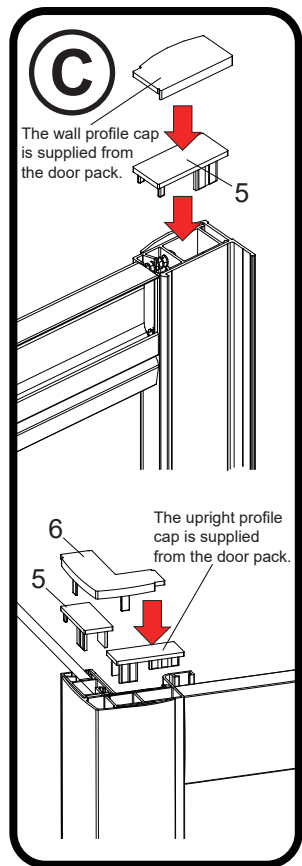
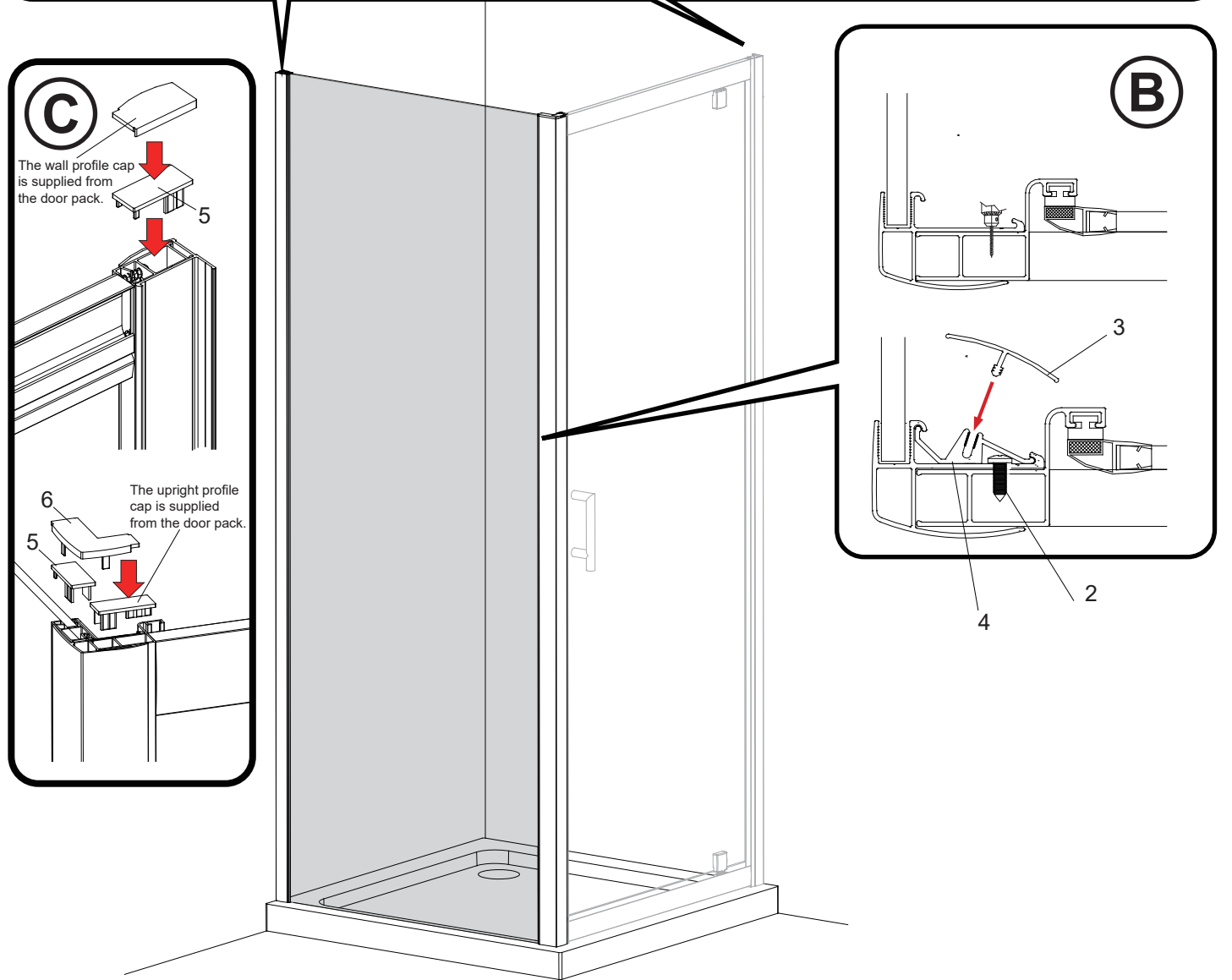
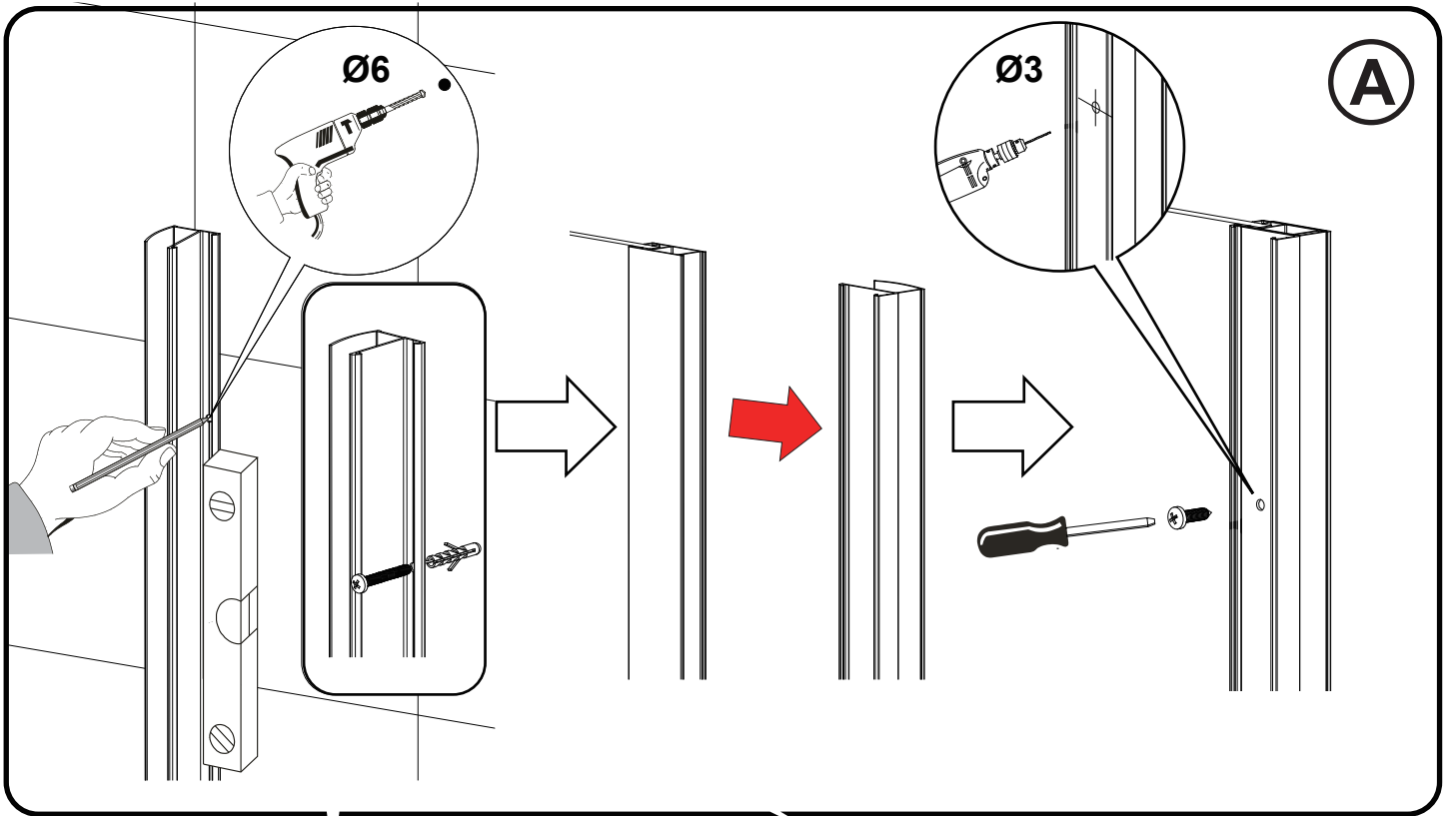

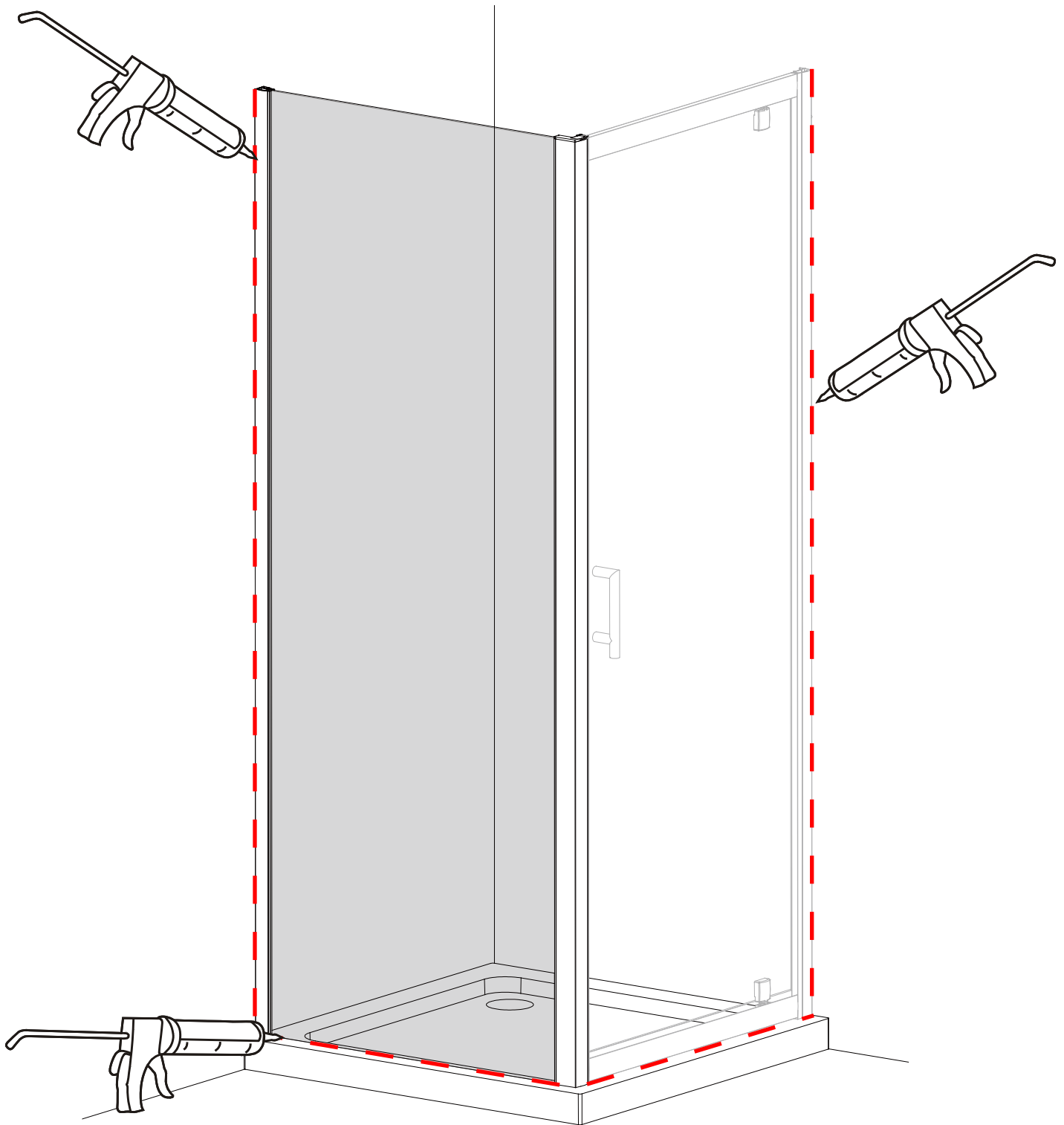

### Applying Silicone Sealant

#### Sealing Inside

Seal from the top of the wall profile to the bottom on the **INSIDE** between the wall profile and the wall.

**IMPORTANT:** Do not apply sealant on inside of tray.

#### Sealing Outside

Seal only along the bottom rail and glass on the **OUTSIDE** between the profile /glass and the tray. Also up between the wall profile and the wall.

Seal also the joints between the bottom profile and any upright profiles.

**24 HRS**



**DO NOT USE THE  
ENCLOSURE FOR  
24 HOURS AFTER  
SEALING**