

# Sandringham 21 Bath 150x70cm 2 Tapholes With Handgrips And Tread pattern

## ILLUSTRATED

- E0286** Sandringham 21 bath 150 x 70cm 2 tapholes with handgrips and tread pattern
- B9870** Sandringham 21 bath filler 2 hole
- S1017** Sandringham 21 front bath panel 150cm
- S1020** Sandringham 21 end bath panel 70cm
- S8970** Trap 1½" plastic P with 75mm seal, multi-purpose outlet suitable for plastic and BS copper pipe
- S8830** Waste 1½" bath chain and overflow, plastic plug
- A5901** TMV Thermostatic mixing valve 22mm

## ILLUSTRATED PRODUCT DETAILS







### Weights

- E0286** 18.00 KG
- B9870** 2.10 KG
- S1017** 3.30 KG
- S1020** 1.80 KG
- S8970** 1.00 KG
- S8830** 1.78 KG
- A5901** 1.70 KG

### Materials

- E0286** Idealform
- B9870** Chrome Plated Brass
- S1017** Acrylic
- S1020** Acrylic
- S8970** Plastic
- S8830** Mixed Material
- A5901** Chrome Plated Metal

### Finishes

- E0286**  White (01)
- B9870**  Chrome (AA)
- S1017**  White (01)
- S1020**  White (01)
- S8970**  Neutral / No Finish (67)
- S8830**  Chrome (AA)
- A5901**  Chrome (AA)

### Capacity

- E0286** 148 litres (to overflow)

### Flow rates

- B9870** 16.5 Litres per minute @ 3 bar pressure

### Standards

Constructed to EN 198:2008. EN 14516

### Special Notes

Consideration should be given to safe hot water delivery and the use of an appropriate temperature reduction device see part G for guidance.

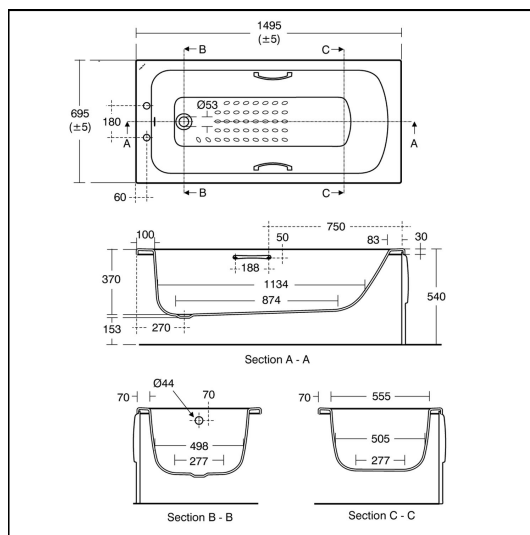

## ACCREDITATIONS

**E0286(01)**

**B9870(AA)**

## FEATURES

