

Sandringham 21 Bath 170x70cm 2 Tapholes With Handgrips And Tread pattern

ILLUSTRATED

- E0284** Sandringham 21 bath 170 x 70cm 2 tapholes with chrome plated handgrips and tread pattern
- B9870** Sandringham 21 bath filler 2 hole
- S1019** Sandringham 21 front bath panel 170cm
- S1020** Sandringham 21 end bath panel 70cm
- S8970** Trap 1½" plastic P with 75mm seal, multi-purpose outlet suitable for plastic and BS copper pipe
- S8830** Waste 1½" bath chain and overflow, plastic plug
- A5901** TMV Thermostatic mixing valve 22mm

ILLUSTRATED PRODUCT DETAILS







Weights

- E0284** 20.00 KG
- B9870** 2.10 KG
- S1019** 3.60 KG
- S1020** 1.80 KG
- S8970** 1.00 KG
- S8830** 1.78 KG
- A5901** 1.70 KG

Materials

- E0284** Idealform
- B9870** Chrome Plated Brass
- S1019** Acrylic
- S1020** Acrylic
- S8970** Plastic
- S8830** Mixed Material
- A5901** Chrome Plated Metal

Finishes

- E0284**  White (01)
- B9870**  Chrome (AA)
- S1019**  White (01)
- S1020**  White (01)
- S8970**  Neutral / No Finish (67)
- S8830**  Chrome (AA)
- A5901**  Chrome (AA)

Capacity

- E0284** 174 litres (to overflow)

Flow rates

- B9870** 16.5 Litres per minute @ 3 bar pressure

Standards

Constructed to EN 198:2008. EN 14516

Special Notes

Frame and supports inclusive.

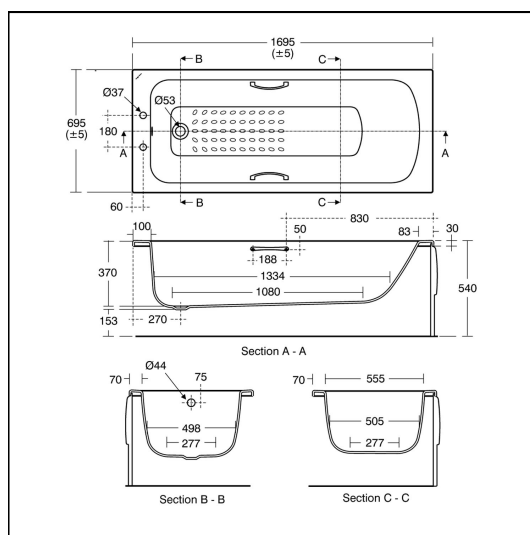

ACCREDITATIONS

E0284(01)

water label   **174.0** Litres

B9870(AA)

water label   **16.50** Litres Per Minute

FEATURES

