

Sales Code: BFAFB12

Description: ABSTRACT 1200 Screen With Arms And Feet

Packaging Details

Barcode: 5056462644349

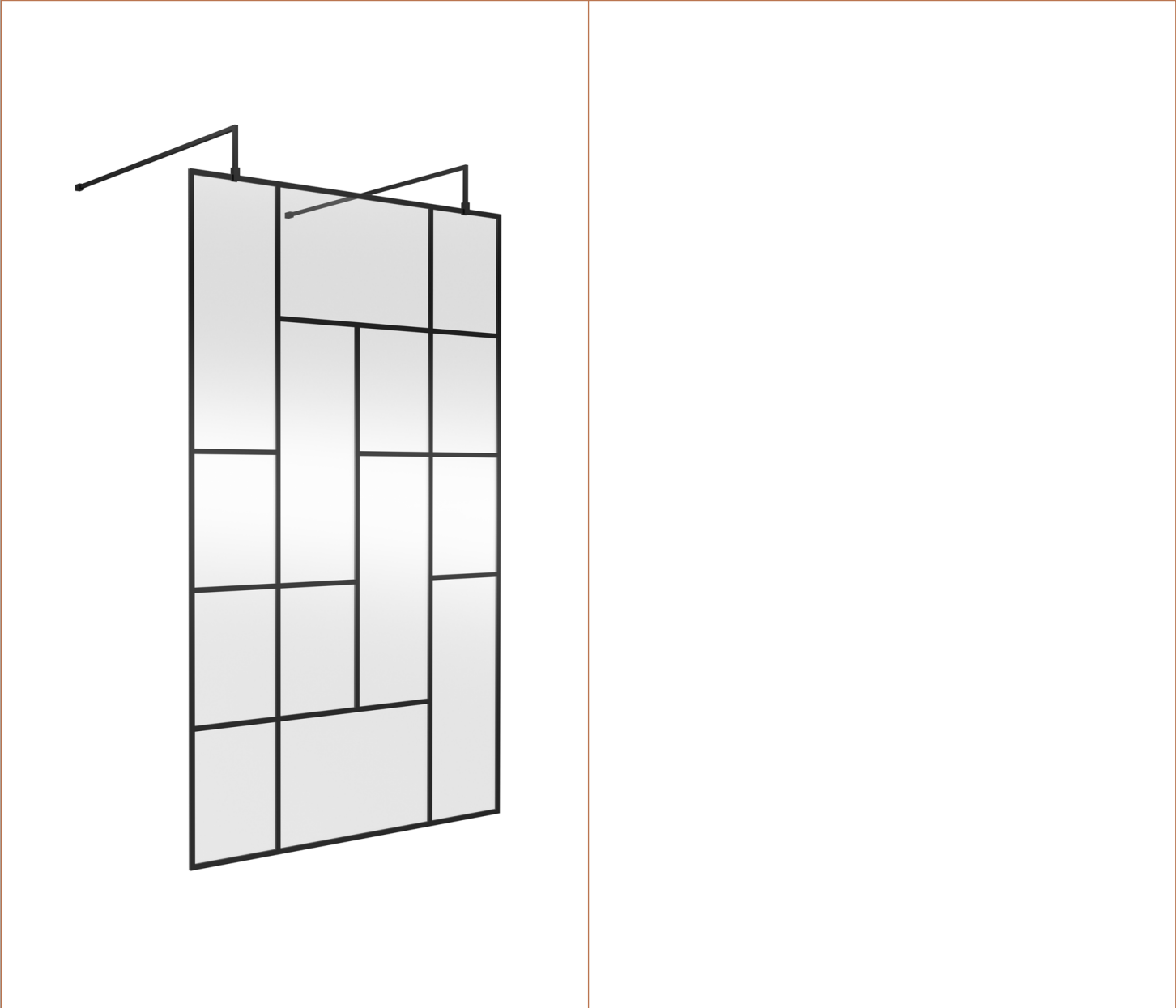

Sales Code: WRSFB12

Description: ABSTRACT Frm Wetroom Screen 1200X1950x8

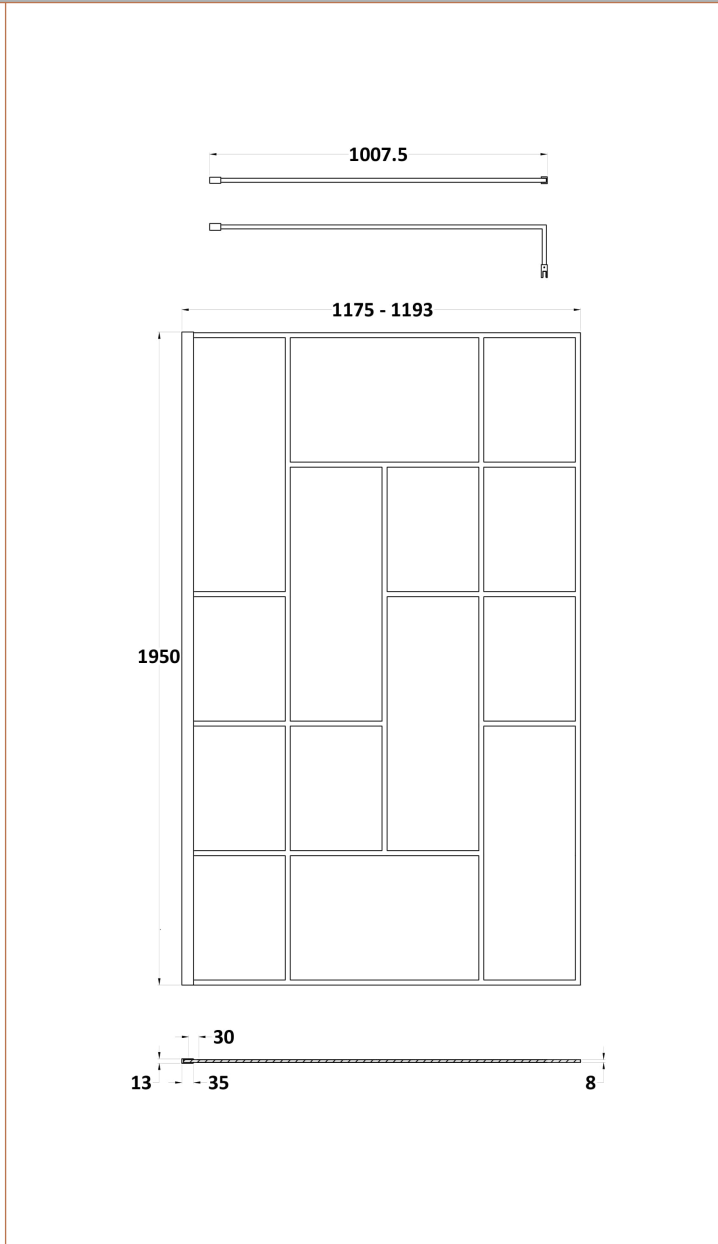

Product Dimensions

Height (mm):	1950
Width (mm):	1200
Depth (mm):	14
Nett Weight (kg):	52.7

Packaging Dimensions

Height (mm):	60
Width (mm):	1250
Length (mm):	2070
Gross Weight (kg):	53.2

Packaging Data

Box Colour:	Brown Cardboard Box - Printed
Box Qty:	1
Label Size:	x
Label Colour:	Not Applicable
Label Qty:	0

Outer Box Dimensions (If Applicable)

Height (mm):	
Width (mm):	
Depth (mm):	
Length (mm):	
Gross Weight (kg):	
Barcode:	5056462614175

Product Details

Country of Origin:	China
Fitting Instruction:	No
CE Approval:	Yes
Profile Material:	Aluminium
Profile Finish:	Matt Black
Adjustments (mm):	1180mm-1200mm
Entry Width (mm):	N/A
Swing In Dim (mm):	N/A
Swing Out Dim (mm):	N/A
Radius (mm):	Not Applicable
Glass Thickness (mm):	8
Easy Fit:	No
Easy Clean:	No
Handle Style:	Not Applicable
Handle Material:	Not Applicable
Enclosure Design:	Frameless
Wheel Type:	Not Applicable
Support Bar Included:	Support Bar Included
Extras:	None

Sales Code: WRSF007

Description: Wetroom Screen Horseshoe Support Foot

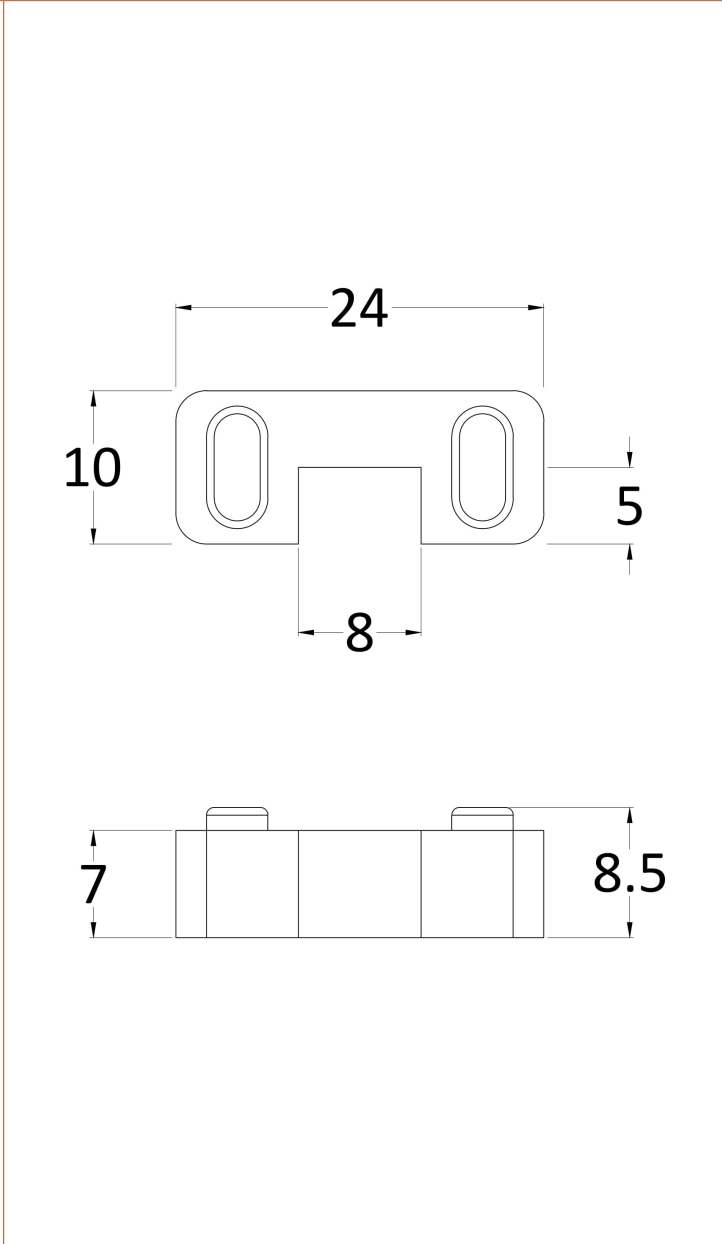

Product Dimensions

Height (mm):	9
Width (mm):	24
Depth (mm):	10
Nett Weight (kg):	0.16

Packaging Dimensions

Height (mm):	45
Width (mm):	30
Length (mm):	44
Gross Weight (kg):	0.16

Packaging Data

Box Colour:	White Cardboard Box
Box Qty:	1
Label Size:	100 x 50
Label Colour:	White Label
Label Qty:	1

Outer Box Dimensions (If Applicable)

Height (mm):	360
Width (mm):	270
Depth (mm):	
Length (mm):	
Gross Weight (kg):	
Barcode:	5056211850625

Product Details

Country of Origin:	China
Fitting Instruction:	No
CE Approval:	N/A
Profile Material:	Brass
Profile Finish:	Matt Black
Adjustments (mm):	N/A
Entry Width (mm):	N/A
Swing In Dim (mm):	N/A
Swing Out Dim (mm):	N/A
Radius (mm):	Not Applicable
Glass Thickness (mm):	
Easy Fit:	Not Applicable
Easy Clean:	Not Applicable
Handle Style:	Not Applicable
Handle Material:	Not Applicable
Enclosure Design:	Not Applicable
Wheel Type:	Not Applicable
Support Bar Included:	Support Bar Not Included
Extras:	None

Sales Code: FIX024

Description: Wetroom Screen Support Arm

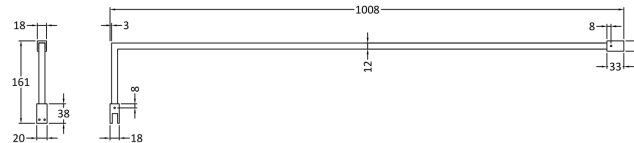

Product Dimensions

Height (mm):	15
Width (mm):	150
Depth (mm):	1000
Nett Weight (kg):	0.67

Packaging Dimensions

Height (mm):	35
Width (mm):	160
Length (mm):	1020
Gross Weight (kg):	0.7

Packaging Data

Box Colour:	Brown Cardboard Box
Box Qty:	1
Label Size:	100 x 50
Label Colour:	White Label
Label Qty:	1

Outer Box Dimensions (If Applicable)

Height (mm):	
Width (mm):	
Depth (mm):	
Length (mm):	
Gross Weight (kg):	
Barcode:	5056211847342

Product Details

Country of Origin:	China
Fitting Instruction:	No
CE Approval:	N/A
Profile Material:	Stainless Steel
Profile Finish:	Matt Black
Adjustments (mm):	N/A
Entry Width (mm):	N/A
Swing In Dim (mm):	N/A
Swing Out Dim (mm):	N/A
Radius (mm):	Not Applicable
Glass Thickness (mm):	
Easy Fit:	Not Applicable
Easy Clean:	Not Applicable
Handle Style:	Not Applicable
Handle Material:	Not Applicable
Enclosure Design:	Not Applicable
Wheel Type:	Not Applicable
Support Bar Included:	
Extras:	None