

IXMO
59556071002 2-way diverter valve DN 15

PRODUCT

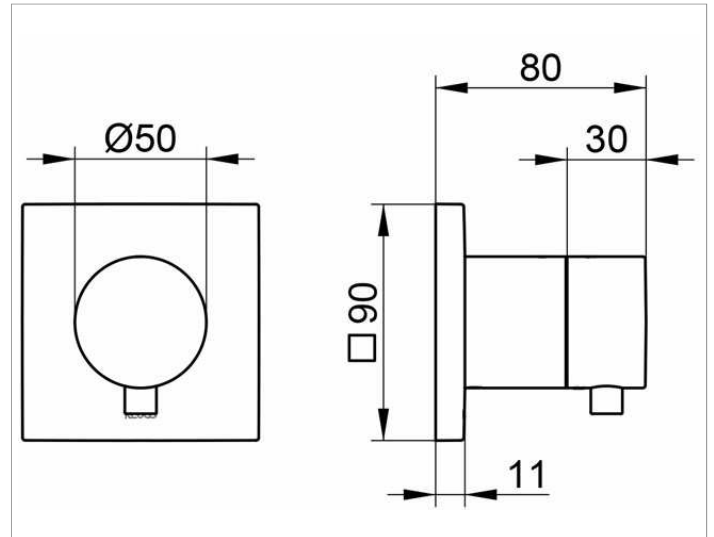

DRAWING



PRODUCT ATTRIBUTES

Set complete with:
 handle, casing, rosette (square) and diverter valve
 suitable for rough part no. 59556 000070

SURFACE

stainless steel finish