

IXMO

59556070001 2-way diverter valve DN 15

PRODUCT



DRAWING

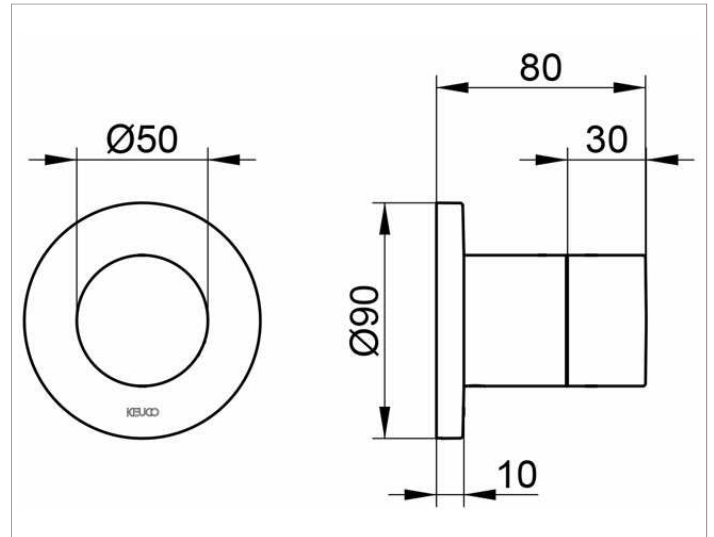

PRODUCT ATTRIBUTES

Set complete with:
 handle, casing, rosette (round) and diverter valve
 suitable for rough part no. 59556 000070

SURFACE

stainless steel finish