

IXMO
59541YY0001 Stop valve DN 15

PRODUCT

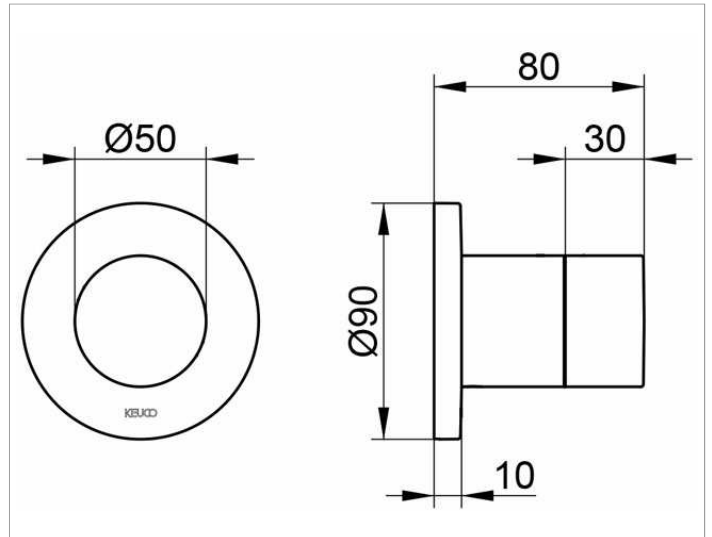

DRAWING



PRODUCT ATTRIBUTES

Set complete with:
 handle, casing, rosette (round) and stop cock
 suitable for rough part no. 59541 000070

SURFACE

03, 05, 13