

IXMO
59541XX0001 Stop valve DN 15

PRODUCT

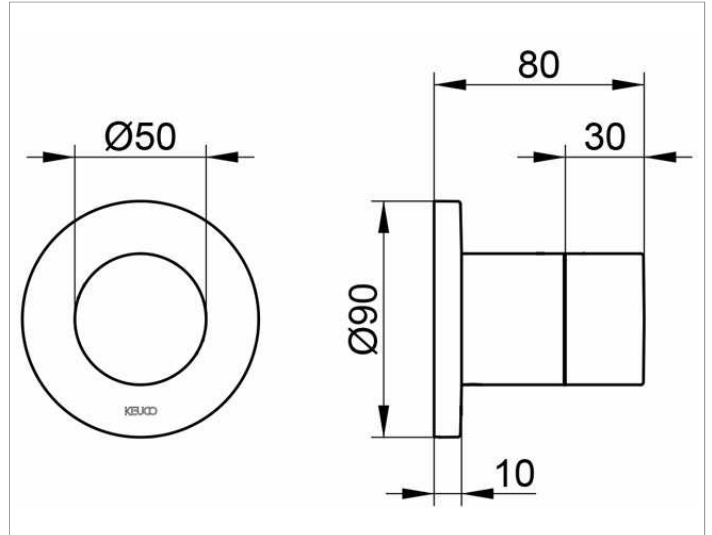

DRAWING



PRODUCT ATTRIBUTES

Set complete with:
handle, casing, rosette (round) and stop cock
suitable for rough part no. 59541 000070

SURFACE

02, 04, 12