

IXMO
59541171002 Stop valve DN 15

PRODUCT

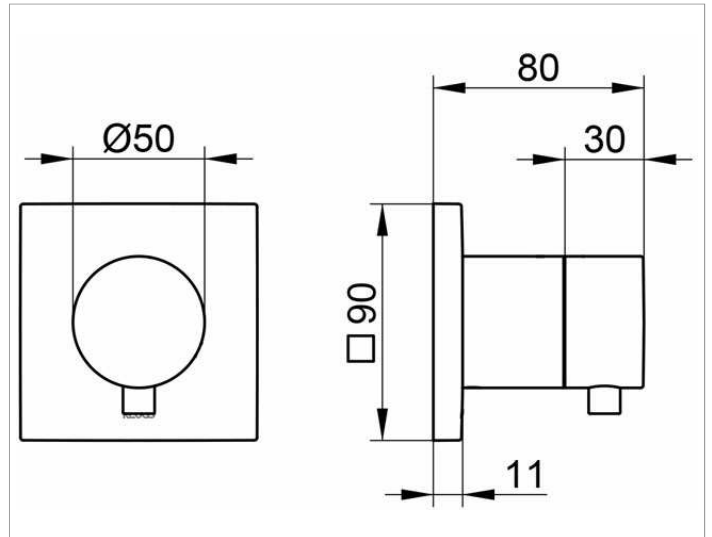

DRAWING



PRODUCT ATTRIBUTES

Set complete with:
 handle, casing, rosette (square) and stop cock
 suitable for rough part no. 59541 000070

SURFACE

aluminium finish