

IXMO
59541071002 Stop valve DN 15

PRODUCT

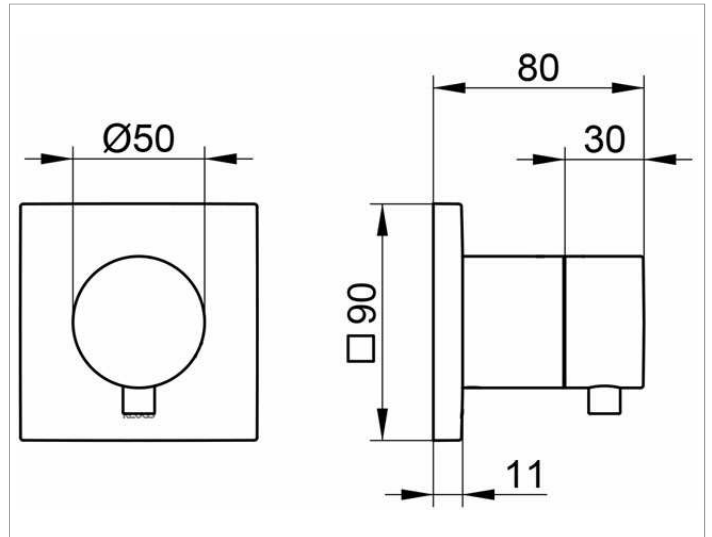

DRAWING



PRODUCT ATTRIBUTES

Set complete with:
handle, casing, rosette (square) and stop cock
suitable for rough part no. 59541 000070

SURFACE

stainless steel finish